

THE SECRET SCIENCE OF  
ECSTASY AND IMMORTALITY

# IMPLORSION

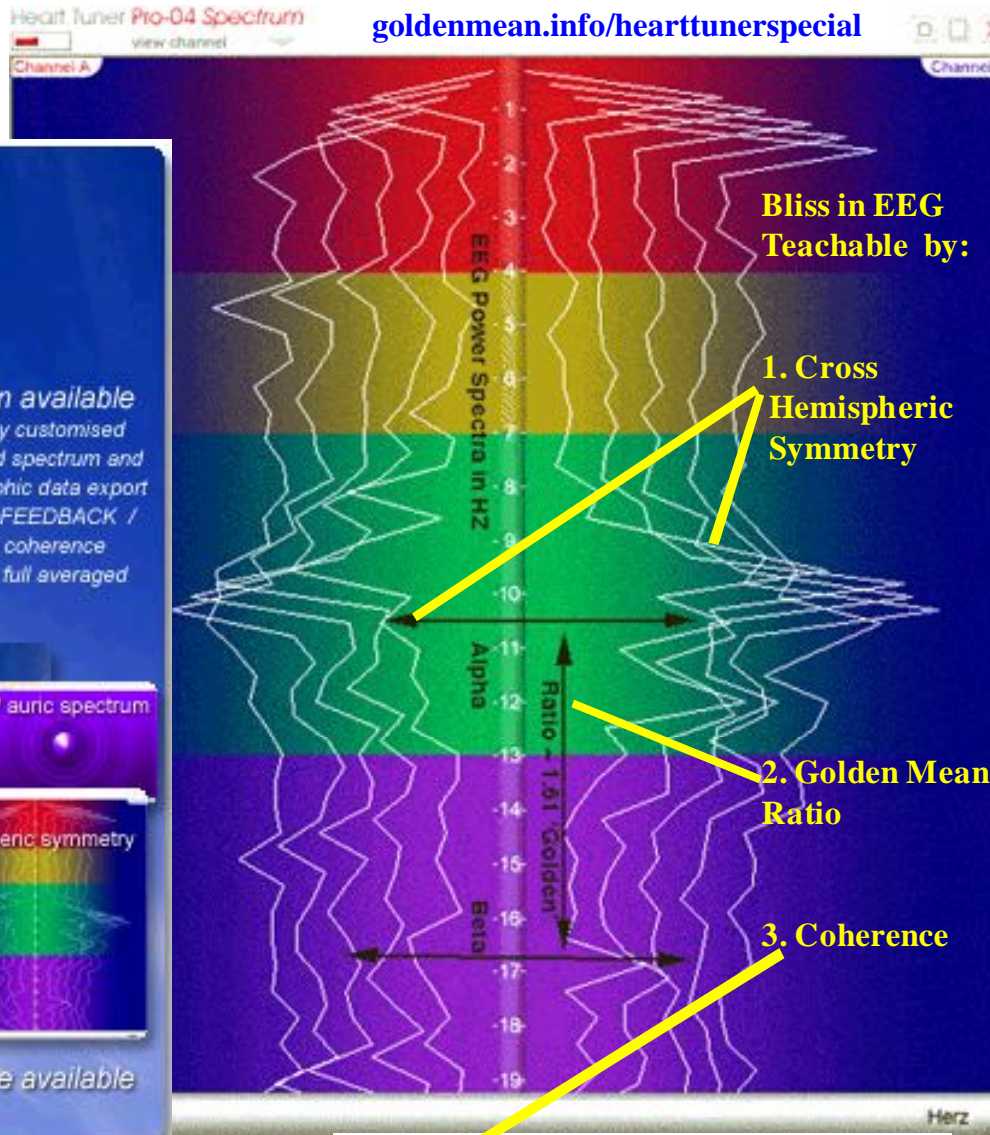


Dan Winter  
Inspired by Valerie Sandelin



# HeartTuner Pro-04:

Includes Many New Modules:  
Bliss Tuner for Brainwaves ->

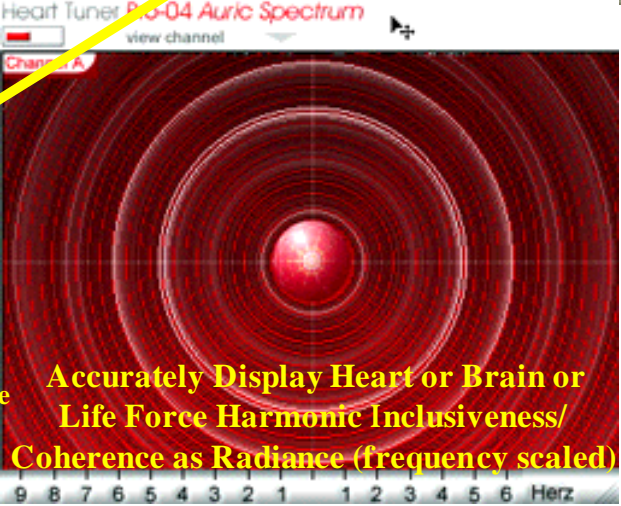
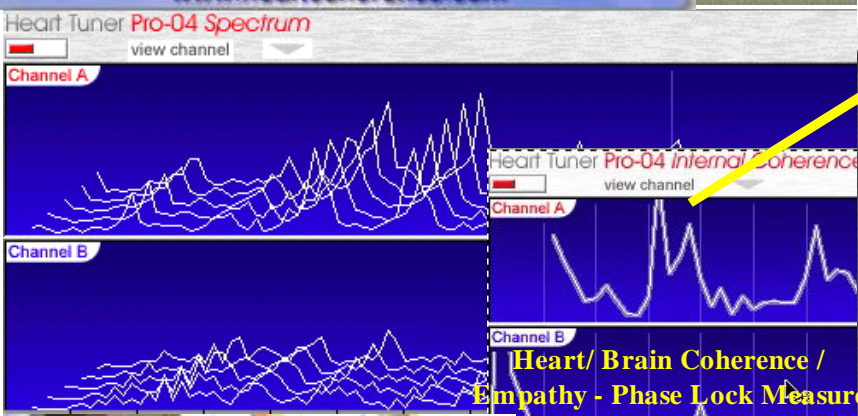


**Heart Coherence**  
heartcoherence.com  
*THE NEW*  
**HEART TUNER Pro-04**

fully upgraded modular version, soon available featuring: - enhanced graphic user interface- fully customised screen layouts for EEG - ECG - HRV, enhanced spectrum and other applications - automated numeric and graphic data export - NEW HEART AND BRAIN GAME STYLE BIOFEEDBACK / NEUROFEEDBACK including long term internal coherence history, cross-hemispheric coherence - waterfall full averaged spectrum and sepstrum - many more ...

NEW life force / auric spectrum  
NEW cross-hemispheric symmetry  
NEW game style biofeedback reward

functional demo's and sales soon online available  
www.heartcoherence.com



The Heart Coherence team - using the basic insight from Winter, successfully launched Heart / EKG biofeedback making **empathy** (phase lock ) and **coherent emotion** (passion) measurable (using 2 channel cepstrum of EKG). The new HeartTuner Pro04 software includes 'BlissTuner' to allow **3 of the most important features of BLISS - to be gently and carefully teachable in the new 2 channel brainwave setup for HeartTuner:**

- A- **Golden Ratio** between the Major Harmonics - Usually Alpha to Beta in EEG Spectra. See Korotkov- goldenmean.info/blisstuner
- B- Cross Hemispheric Synchrony (Both Hemispheres in Symmetry )
- C - Overall Internal COHERENCE.



# 1 IMPLOSION: Secret Science of Ecstasy and Immortality

## Conscious Kids: Spiritual Path Based on Simple Science Young People

Bliss-Ecstasy- Immortality Made Easy:

for the Young & Young at Heart

from writings of Dan Winter , assembled & shared by IMPLOSION GROUP - [goldenmean.info](http://goldenmean.info)

Inspired by and Dedicated to Valerie Sandelin

**PRESS RELEASE:** World Expert on Sacred Geometry and "The Science & Politics of Bliss" - speaker, teacher and scientist Dan Winter presents talks and seminars in 30 cities 10 countries again this year. See [goldenmean.info/course](http://goldenmean.info/course).

Teaching bliss & ecstasy as a SCIENCE, Dan's programs are designed to empower people of all ages to understand and take responsibility for emotional and evolutionary states, through an intimate understanding of the very Essence of Life. Using vibrant animations and easy-to-follow descriptions, Dan demystifies sacred geometry in nature, the cosmos and even our own DNA as represented by the GOLDEN MEAN RATIO ? the diagram of BLISS.

Quoting from the Rainbow Serpent Festival (attended by 5000 people) Workshop: "Our Festival is honored by the presence of on of the world's leading experts on Sacred Geometry. Dan Winter has mapped the fundamental structures that form the universe and our reality through the physics of sacred geometry. His presentation implements the music of bliss and teaches the scientific nature of self-empowering peak experience. A fascinating source of information and exceptional opportunity for raising awareness."

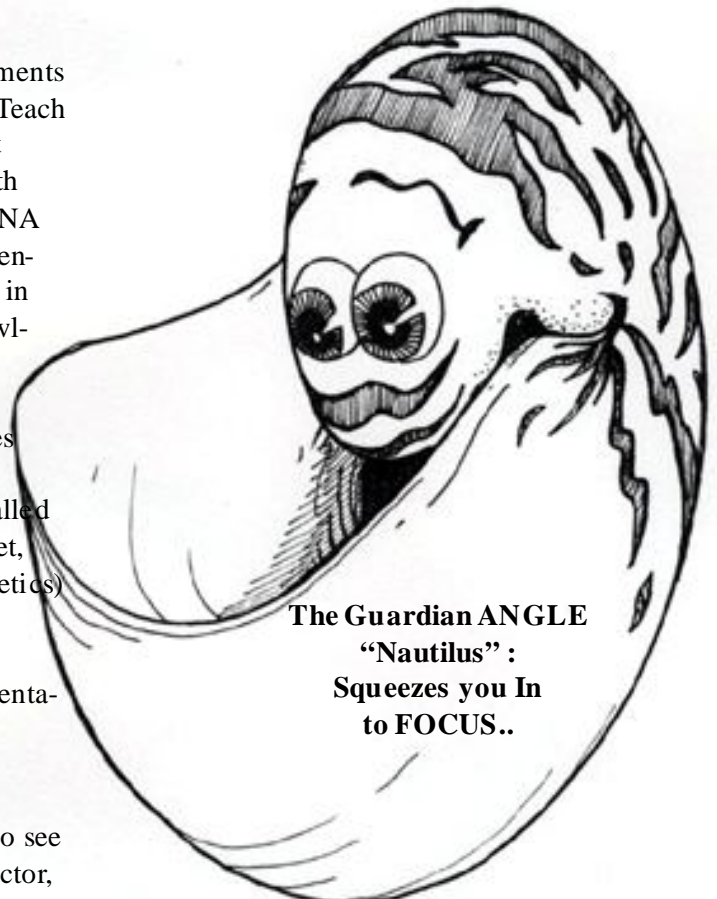
A unique part of Dan's work (featured on BayFM) is his focus on the human heart and the science behind enlightenment. His invention the HeartTuner is sensitive enough to measure moments of EMPATHY and COHERENT EMOTION alone and between people. The computerized equipment analyses an EKG signal in real time and clearly, graphically registers moments of passion, empathy and love. The HeartTuner is currently in use worldwide in clinics, hospitals, and by qualified trainers for addiction recovery, ADD-treatment, holistic healing, Tantra, conflict resolution, even peacemaking politicians! For more information visit: [heartcoherence.com](http://heartcoherence.com)

Dan observes that our culture is virtually devoid of "bliss wisdom" ? it is not taught in schools, endorsed by governments or represented on TV. Read his "Conscious Kids: How to Teach Bliss" new book: [goldenmean.info/consciouskids](http://goldenmean.info/consciouskids) .Without access to real BLISS process, the Optimum Immune Health and Biological Immortality mechanisms inherent in our DNA do not develop or mature. He points to the failure of conventional science for not elevating BLISS to its rightful place in our lives, and is dedicated to passing on both ancient knowledge and modern discoveries.

A fascinating in-depth seminar will explore these mysteries over four days of presentation, discussion, exercises and experiential embodiment of the principles and practices called "Hygiene for Sustaining Bliss" ? involving elements of diet, ecological environment, synchronistic movement (kinesthetics) & group bliss processes.

For the newspaper and magazine articles about Dan's presentation to 5000 young people at Rainbow Serpent Festival - **MUSICAL RECIPES TO BLISS without Drugs!** see [goldenmean.info/rainbowserpent](http://goldenmean.info/rainbowserpent)

For glossary (index to word meanings) and book lists - also see the conclusion to Dan's 4th book: Implosion's Grand Attractor,



**The Guardian ANGLE  
"Nautilus" :  
Squeezes you In  
to FOCUS..**

- P 3. Introduction- Science now knows - **BLISS- is the only way to health AND immortality!**
- P 4. Why it is **Healthy to want Ecstasy**
- P 7. **Politics of Bliss**
- P 8. **Rave Parties and Musical Recipe for BLISS** without Drugs
- P 10. Real Meaning of **SELF - emPOWERment**.
- P 12. **Religion minus Miracle or Personality Worship-** is really about BLISS
- P 13. How does **CREATION Invite YOU to DO it?**
- P 14. Secret of **ATOMS and CREATION** out of DONUTS.
- P 19. Secret of **LETTERS and ALPHABETS** and WRITING.
- P 29. Secret of **DNA and SPIRALS and FIRE IN THE BLOOD**.
- P 35. Secret of **EMOTION takes SHAPE in DNA-** in your BLOOD.
- P 39. Secret of **FRACTALS and 'SELF-EMBEDDING' and RUSSIAN DOLLS**.
- P 40. Secret of **FIBONACCI - NESTING & BRANCHING**.
- P 42. Secret of **BRAIDING DNA - WEAVING CHARGE in your BLOOD - How to Eat Spin!**
- P 43-44. True Secret **SCIENCE behind LORD OF THE RING!** Blood that makes Dreams come REAL!
- P 48. True Secret **Origin of the Bible: The REAL 'Bible Code' in 3D!**
- P 51. Secret of **GRAVITY - It is MORTAL (FATAL) to be stuck below the Speed of Light!**
- P 52. Secret of **IMPLOSION - The Only Way Out of Here!**
- P 54. Secret of the **GOLDEN MEAN**.
- P 56. Why do you **FALL in Love? - the Gravity of the Situation**.
- P 57. Secret of **LOVE - The Divine or Perfectly BRANCHED TOUCH!**
- P 60. Secret of the **SEVENTH SEAL - the SEVENTH SIGN - the SEVENTH SPIN & the RAINBOW!**
- P 64. Not so Secret **Secret of DYING SUCCESSFULLY based in SCIENCE**
- P 66. **Projective Geometry and Etheric Formative Forces** from -Waldorf Science -Steiner
- P 67. Secret of **VISUALIZATION : Creative IMAGINATION** Science.
- P 68. Secret of **FRACTALS and being 'Self Similar': The Inside the LOOKS Like the Outside!**
- P 72. The Electrical Secret of **LIFE and LIFE FORCE: The Ability to ATTRACT CHARGE (Implode)**.
- P 80. Secret of the **KA in Mer-KA-bah: Your FIRE (Phi-re) SHIP at Death and Dream's Door**.
- P 81. Secret **Origin of ROYAL Blood - EMOTION - Programming DNA in your Blood: .**
- P 84. Secret of **INDIGO CHILDREN: Holy BLUE! When Your Blood GLOWS -Indigo**.
- P 86. Secret of **NEPHILIM: The Fallen Ones - When Does DNA Stop SHINING?**
- P 91. Secret of **MAGIC: Shape the CHARGE and Form LIFE**.
- P 95. Secret of **RAPTURE: Compression in the Solar Wind- Test by FIRE** .
- P 104. Secret of **Ending PARASITES: Only the Shareable Survive the FIRE of Compression**.
- P 106. Secret of **HOW LIFE SPREADS: Billiard Balls that TOUCH Perfectly**.
- P 110. Biology versus the **SPIRIT of IMMORTALITY**.
- P 114. Secret of the **Extra Terrestrial Origin of DNA: Assa-Uru and the Dinosaur**.
- P 116. Secret of **SMELL / "Olfaction": Infra-red Notch and Smell the Blood**
- P 118. Secret of the **HEART OF GOLD: Love's Music Measured in the Heart**.
- P 120. Secret of **Dowsing: Can you FEEL Magnetism- Do or Die?**
- P 124. Secret of **LABYRINTHS**.
- P 131. Secret of **Tornado Steering: Alphabet Swallowing and Tornado Entry**.
- P 133. Paying Your **DEBT to GRAVITY**.
- P 136. Most **FATAL ERRORS in SCIENCE**.
- P 142. Secret of **MICROWAVES: They are the Bliss Radio of Glands-Don't Mess with Microwaves**.
- P 145. Secret **LIFE OF TREES**.
- P 148. Secret of **SACRED ARCHITECTURE - LIFE Enters Form when CHARGE IS ATTRACTED**.
- P 157. Secret of **POLARITY - Plus and Minus - Yin and Yang - Converge Diverge- Centrifuge-CentriPEDE?**
- P 162. **WHAT ARE PEOPLE FOR ? - in the Galactic Scheme of Things**.
- P 165. True Secret of **Djedai Knighthood**.
- P 169. Practical **Exercises- SPIN PATH TO THE ZERO POINT - Breath - versus TIME TRAVEL**.
- P 174. **Design Your DIET - Design Your MOVEMENT - Design Your PLACE -- ALL FOR BLISS!**
- P 181. The **CONSCIOUS KITCHEN - Ideas for LIFE FORCE in Food Preparation**.
- P 185. **Valerie's Youthful Spiritual Quest - Bliss Experience Real Life Story -**



**Conscious Kids: Spiritual Path Based on Simple Science Young People**

Bliss-Ecstasy- Immortality Made Easy:

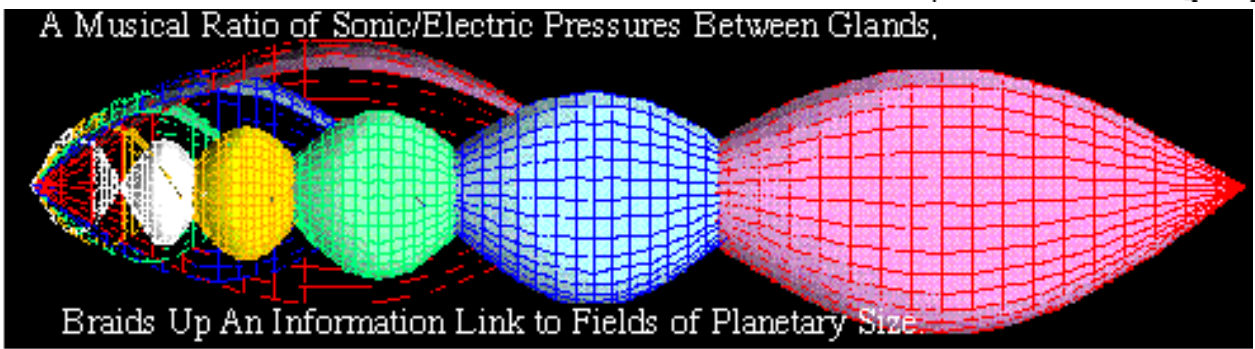
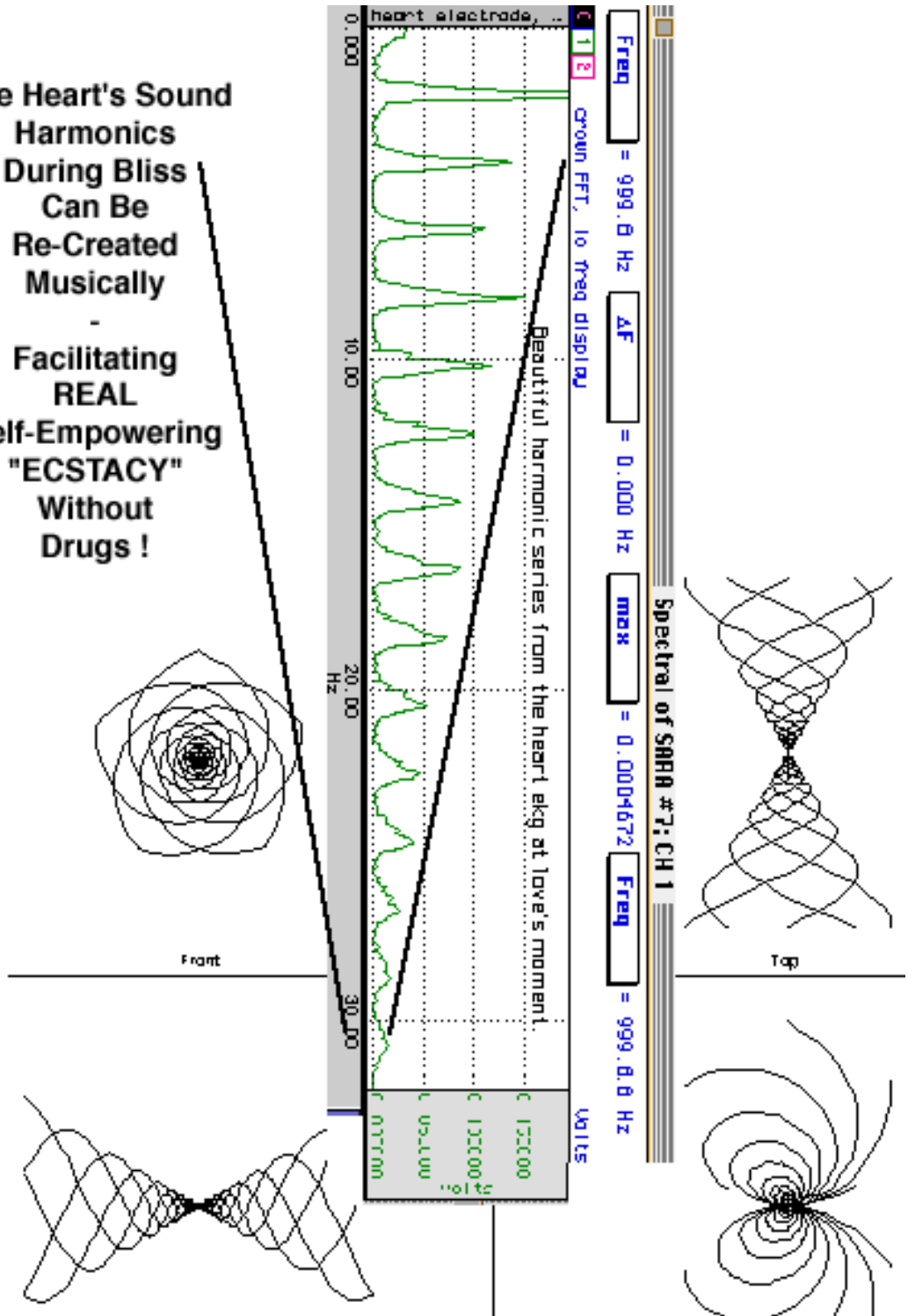
**Chapter ONE: Science Now Knows- BLISS is the only way to Health & Immortality!**

**Introduction:**

Science has now discovered very basic reasons to be on a spiritual path. As we traveled around the world many times in the past few years - teaching Sacred Geometry and the Science of Emotion for Spiritual growth in dozens of countries - one thing has become clear. We need the story about how to get into the spirit life that makes you immortal and enlightened - written in SIMPLE TERMS that YOUNG PEOPLE and the YOUNG AT HEART - can understand and enjoy. This book is dedicated to exactly that.

You see - science has recently realized that most of the really fun parts of religion are actually correct! *It is wonderful to realize that the spiritual revolution in new science and physics - has direct application perhaps ESPECIALLY to young people (and people young at heart!).* You can set your DNA on fire (ignite it to radiate) to make you immortal! It is real science. You can navigate among the stars and see or feel what happens inside and thru the sun!

**The Heart's Sound Harmonics During Bliss Can Be Re-Created Musically - Facilitating REAL Self-Empowering "ECSTASY" Without Drugs!**





We are going to talk about the science with nice pictures. You can study how to die in a way that makes your memory live forever! It is all based on simple science. And perhaps most of all - you can for sure have BLISS - ECSTASY and ENLIGHTENMENT in your own time - if you focus on a few simple new ways to live your life .

**The deep desire to get PEAK EXPERIENCE - or ECSTASY is healthy and even good for survival** - it is not a mistake. You were sure of that the first time you ever got off a roller coaster. Your eyes were perhaps bigger than they had ever been before. You had felt a tingle all over, as your awareness came completely into the present. When you experience acceleration - it compresses your attention. This is actually a deep clue to what happens in your blood and genes as you get ready to die or have ecstasy successfully.

There is a nice connection between BLISS and ECSTASY compared to DYING well. This is one of the fun mysteries we will talk about in this book.

**The urge to have BLISS and ECSTASY - is not a mistake made by God. Just like pain is not a mistake from God. Pain is your body offering to show you where added ATTENTION will restore the wave FOCUS necessary to sort biology back into order. Bliss and ecstasy actually produce something in your Genes and Blood (your DNA) which makes you able to be sustained and immortal.** (pictures coming up in this book on this). In fact you can't really sustain a healthy IMMUNE SYSTEM (really healthy cells in your body) unless you DO get BLISS and ECSTASY! The fact that so many young people end up using drugs to get BLISS and ECSTASY is not a proof that deep bliss is evil. It is only a proof that if our society cannot teach young people REAL BLISS practice- then our kids will risk DEATH to try to get it! And in fact - since without BLISS you lose immortality - therefore you **the young person IS ACTUALLY CORRECT TO BE WILLING TO RISK DEATH RATHER THAN NOT GET BLISS!!**

The fault is that our society made the mistake of believing that Bliss teaching is not important. This is wrong. Recently we asked a young girl with twinkle in her eyes, in Austria - about what was her passion - what was her bliss? She was telling about being in business school - and sounded pretty dull and not enthusiastic about that. So it seemed right to ask **where was the fire in life for her-- what really got her juices going?** She seemed really intelligent and thought slowly about the question - where is your passion or bliss?

Then she said- "I really don't know what my bliss is." Next - after she thought even a little more she said: "And

**The FIRE of BLISS in your BLOOD (The field effect of emotionally COHERENT (ringing) DNA ) is a gravity making 'Dreamspell'**

**Simple science now confirms the Mayan wisdom:**

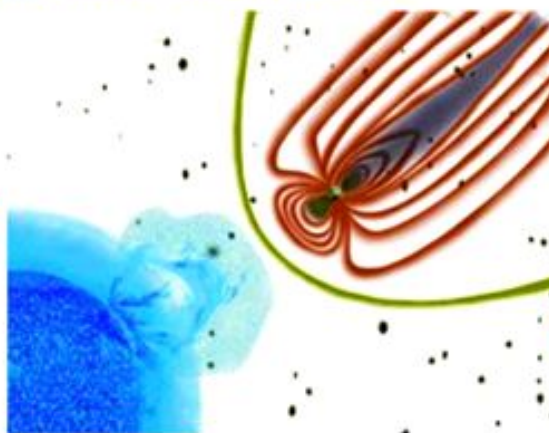
**"Unless the DREAMSPELL of the 'Old Ones' is alive and awake in symmetry space - Earth will be 'blown away' in the magnetic wind of the Sun."**



•Solar Flares measured deflected when millions of children sing together.

•Weight loss accompanies dying

•Radioactive half life reduced measurably using only Focused attention.



Global Coherent BLISS experience: "Harmonic Module" Solution to Solar Maxima (2004-2012) potential destruction by compression (The 'rapture')

**In addition to it's role in Gravity making.. ("Songline" wormhole maintenance..?)**

**When the 'zipper' up the long axis of DNA braids or knots To accelerate thru light-speed sustainably -- this facilitates Lucid dream, and sustaining memory thru death... "ensoulment"**

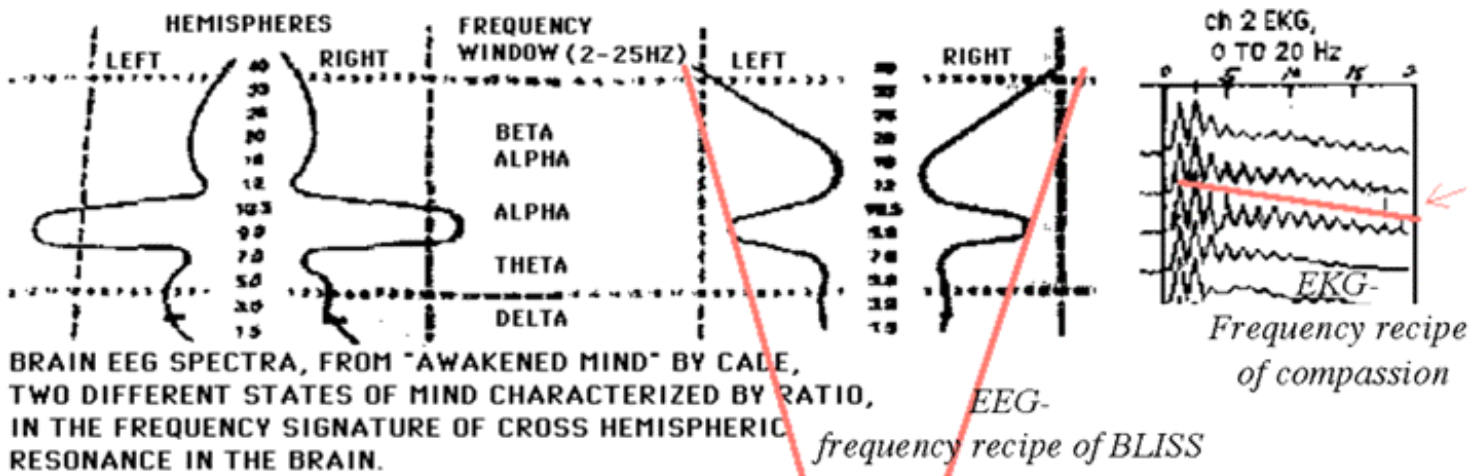


you know what- **I never even knew that I am supposed to know what my bliss is!!**". So there's the 'rub' - the drama. Many years of primary and secondary and then professional education - and never once did anyone tell her to learn to **FOLLOW YOUR BLISS!!**

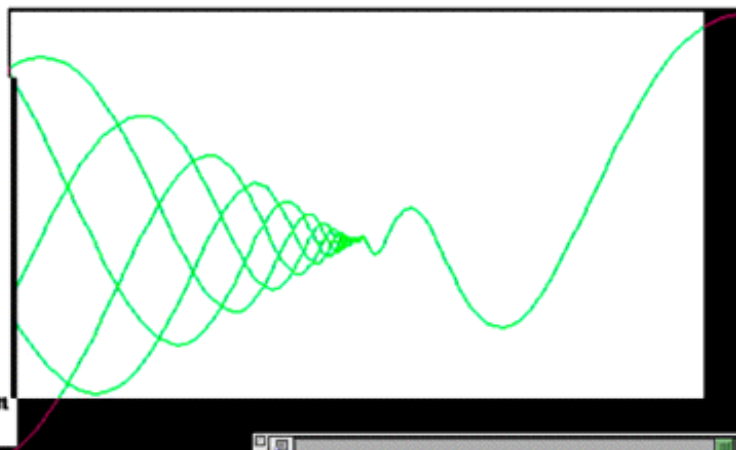
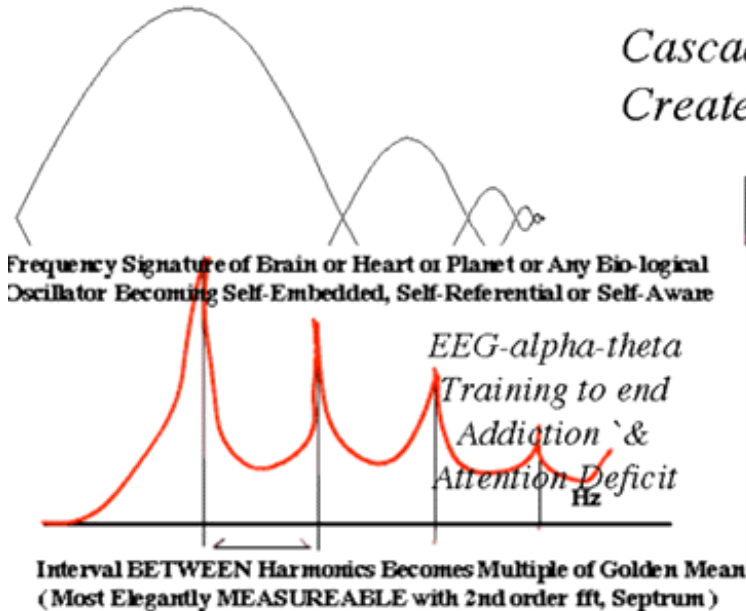
And yet this book clearly presents simple science to show that **BLISS AND ECSTASY IS HOW YOU GET HEALTH AND- HOW YOU GET IMMORTAL!**

Therefore - **the fault of young people getting messed up while trying to get BLISS (drugs and fast cars and sex with no love - and so on) - actually lies mostly with a society ( school ) that does not know what bliss is, why it is necessary in order to survive, and how to teach it in practice. This book is written to fix that problem** - which is very important - and at the heart of the matter.

Addiction is simply a wrong turn - in the attempt to make BLISS. When a beer drinker finds a way to make the brain wave music (neurofeedback) to attract charge (ecstasy science) that is the moment when his next drink of beer will make him sick. The brain wave music that **MAKES** bliss is a **CASCADE** of compression. ( Biofeedback - can heal addiction and Attention Deficit - see [goldenmean.info/ritalin](http://goldenmean.info/ritalin) ).



*Cascade of Harmonics-sucks in CHARGE..  
Creates: ATTENTION, LIFE, BLISS.*



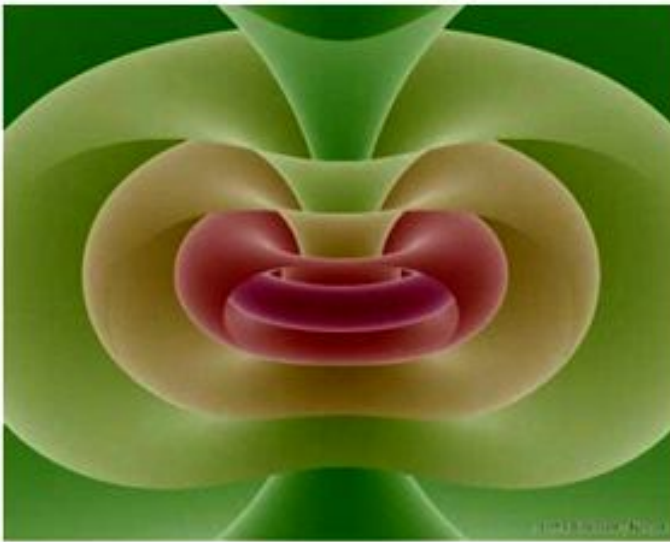
Bliss and enlightenment are simple science, not even complicated. They are required for evolution and immortality. And they are about the highest and best reasons for living... **BECAUSE THEY ARE EVEN MORE FUN THAN DISNEY WORLD.** (In fact once the people at Disney World actually learn what the science of bliss is - they are going to rush to re-design the place. see [goldenmean.info/fusion](http://goldenmean.info/fusion) ).

If you knew all the wonderful shaman who had gotten on a ride of waves inside their body and seen thru the sun like it was an eyeball - and actually gone into the stars!!! - would you maybe put that on your wish list OVER Disney World? All of this is possible for you. It really is. The only trick is to understand a few simple principles



(rules) which help get all these wonderful waves focused into your own body. How waves get attracted to want to come in to your body - has a name: "IMPLOSION'S GRAND ATTRACTOR". (This is the adult book about bliss - [goldenmean.info/newbook](http://goldenmean.info/newbook) , and the manual for the course we teach). What's neat is - these rules about waves getting attracted to you - actually do make YOU a GRAND ATTRACTOR - and that is really sexy!! (in the nicest sense).

**By design & by braiding, capable of so much self-similar  
implosive compression:  
DNA SQUEEZES biological magnetism  
Thru the speed of light into GRAVITY WELLS..  
Fabricating Gravity.. As the geometer of consciousness it's  
Symmetry inserts the embedding which keeps little tornadoes  
Nested inside bigger ones...**



**Thus consciousness as embedding  
(self-reference) maintained  
Becomes the physics of the GLUE  
Which holds fields together.**

*Science shows..  
Love is the GLUE  
That Holds things Together*

**Infinite Non-Destructive Compression - because of recursive adding and  
Multiplying of wavelength AND velocity - PRODUCES the acceleration  
Einstein knew is identical to gravity.**

**More about who this book is for:**

This book is written intended for young people probably starting at around age 11 or older who really want to understand about religion, bliss, ecstasy, spiritual path and life's meaning. It is good especially for young people interested in science. This book assumes only that you are reasonably intelligent, and curious - but that you don't need fancy words or degrees in science in order to understand SPIRIT in practical science. This book is ALSO intended for adults who want the simplified introduction to all these subjects. It is **for all who want a playful, happy, easy way in to spiritual practice based on solid scientific rules for how bodies get into ENLIGHTENMENT and BLISS.**

The book does assume you can read pretty well, but tries to limit complicated words. So whenever we introduce a word which is not common, we will try to tell about the word first (define it). Like for example - we want you to know what a HOLOGRAM is and we want you to know what COHERENCE is - like laser light. But when we use these words, we are going to tell stories to help you know what the word means. Also in the back the more advanced book, (Implosion's Grand Attractor - [goldenmean.info/newbook](http://goldenmean.info/newbook) ) you will find the glossary (list of words used) is fun to check out - there are pictures too -, and use like an index.

(continued p 9.)



From Conscious Living Magazine, Issue 61, Spring 2002,  
Condensed extract from an article by Dan Winter, the co-developer of the Heart Tuner.  
See: [soulinvitation.com](http://soulinvitation.com)



Dan Winter -

for the rest of this article-  
see: Politics of Bliss at  
[goldenmean.info/rainbowserpent](http://goldenmean.info/rainbowserpent)

# The Politics of Bliss

**Bliss is threatening to a culture because it is inherently addicting and contagious. Like atomic reactions, Bliss has a critical mass for groups. Whatever or, more particularly, whoever is perceived as the major source of Bliss activity will tend to be worshipped (often as a guru) or loved. This may result in the formation of a cult that is permissive and whose members behave in ways that appear “irrational” to the rest of the community.**

**This means Bliss techniques that become popular tend to become burning political issues and involve the law.**

For humanity to survive, however, all laws must be re-examined in light of whether they permit humanity, and especially our children, to sustain Bliss.

## The Electrical Definition of Bliss

Bliss is the condition of the ability to radiate charge to infinity sustainably. This requires perfect fractal embedding. It is also the (self-referent) definition of how electrical fields become self organizing and self aware. More detail on measuring the onset of Bliss requires

introducing spectrum analysis to identify harmonic cascades. This is the principle behind the Heartlink EKG harmonic analysis. It is not just the EKG which identifies its bliss and charge radiance moment as becoming a Phi cascade, this also becomes the harmonic signature of:

- a) Planet long magnetic lines becoming self-aware (Gaia hypothesis physics).
- b) Cancer membranes becoming again healthy and embeddable/touch permissive (<http://www.soulinvitation.com/cancer>).
- c) Public utilities changing 60 Hz in their grid to a Phi harmonic based on Hydrogen and the Schumann

resonance, so our power grid feeds gravity and awareness. (See “What’s Poisoning the Farm”.)

- d) DNA enveloping itself in long wave folds based on Phi multiples to enable ensouling, lucid dreaming, time travel.
- e) Voice prints which heal, and (sun) light optical spectra which serve life natural spectra in classroom lighting creates attention span, while the mercury vapor light spectra at your gas station or grocery store is measurably killing you and everything alive underneath it.

## The Religious History of Bliss

more at-  
[goldenmean.info/rainbowserpent](http://goldenmean.info/rainbowserpent)

from Dan Winter Nov 2002. Rainbow Serpent Festival, Melbourne - [goldenmean.info/rainbowserpent](http://goldenmean.info/rainbowserpent)

**ROCK & RAVE: Ecstasy with Purpose?** New scientific understanding of what bliss and peak experience is - re-defines "Bliss Dance" at festivals for the young - like the huge Rainbow Serpent in Australia.  
**Making Group BLISS is natural and necessary for health.**



The key is to understand 1. that the recipes musically for bliss / and peak experience are well documented [goldenmean.info/brainphire](http://goldenmean.info/brainphire) ( Brainwave EEG nest in Golden Ratio during bliss / euphoria in Russian study ) , Ref. 2. How the Geometry of Pressure in Your TOUCH - Predicts the Harmonics of EMOTION IN MUSIC- & LOVE? , Ref. 3. The musical key signature of the Heart EKG can be taught to EMBED - and BLISSFULLY attract LIFE FORCE GIVING CHARGE -- with a simple musical feedback environment.. HeartTuner. ([heartcoherence.com](http://heartcoherence.com) ) Not only does this make bliss / euphoria and peak experience teachable as a science, but it reveals the powerful and gravity making nature of biological implosion as perfect compression - directly from the music of the heart.



Bio-feedback and sound direct from your Heart - can replace the key missing brain wave harmonics to complete the cascade (EEG) which we now know to be the definition of BLISS and thus replace external drug addictive with self-empowerment.

**What we do in Earth Dance is prove that we can use accurate sound harmonics from the HEART - WITH sacred geometry AND biofeedback, to create a SELF EMPOWERING ecstatic and bliss environment, in which there would be no urge or need for drugs.**

Thanks to Olaf - <http://olaffalo.i.am> for these pics & for his help setting this up!

*The sound of the HEART can also be used to steer the laser light. Geometry from a heart on fire - linked to the music - can guide the waves of charge into center - the world of bliss.*





### **Is there a test for the end of this book - to prove you learned it?**

The only test is whether you get bliss, ecstasy and enlightenment. And you are going to be surprised how easy it is. And the nice thing is - **only you give yourself the test** - and you are the only one who ever gets to put a grade on your own test - and decide if you passed. If you do pass, you get immortal memory, and you get to become the gravity..and the center of stars! Really - no kidding.

The conclusion of this book - is a clear instruction to the professor of astronomy at college - that when their children - ask the professor - **AM I GOING TO GROW UP AND BECOME A STAR?** The correct answer - from carefully studied science is **YES!!!** If you don't believe me - keep reading and check out the pictures of how blood and genes (DNA) actually **MAKE GRAVITY!**

Now what happens if you don't pass the test- and don't get to bliss and ecstasy and enlightenment? The neat thing is that there is no real failure. If you try to put into practice even a few of the simple rules outlined in this book - they are rules about simple practices for living clearly - then you will speed up the evolution of your genes and awareness. What used to be called spiritual practice is really a name for tempting waves to center themselves inside you so that you can steer them. This makes you think and feel and act - with more focus and clearness and power.

These practices really turn out to be the long term self made solutions to things like **ATTENTION DEFICIT** and **ADDICTION**. **ATTENTION is the fusion - the centering- of these waves we talk about. Coherent emotion is the glue (The Implosion) that holds waves together. ADDICTION is simply a wrong turn on the path to BLISS. Bliss is the ultimate or perfected compression of attention (charge) - the perfect educator- because charge attraction / implosion IS biological information.**

The simple electrical rules for how to get this **CHARGE** into yourself- which are the main ending of this book - are helpful to everyone, and are carefully presented to be powerful and safe. They amount to what is called **HYGIENE**.

Hygiene is named after the Greek God "Hygeia". You used to think that hygiene meant remembering to wash your hands in the bathroom, and brush your teeth before bed. This is true, but hygiene for spiritual growing actually extends to most everything you do everyday. You would be surprised how much fun it is going to be to understand the **DEEP REASON** why so many old sayings and religions - actually have good science behind them. Like Jewish people saying that meat with cloven (split) feet is bad to eat. (Like pork). Actually it is true that the way electrical 'ground' or nesting of waves - goes up the foot of an animal with a split foot - actually effects whether the meat delivers to you proper connection to Earth memory! (Earth messages are in 'ground')

Or have you ever wondered why you don't like drinking water out of a metal cup - or why you like your pizza better from a wood oven than from a microwave? They are actually all very practical reasons why some of these practices called **HYGIENE** - actually feed your spirit better. Once you understand deeply for yourself the real **PRINCIPLE** or **RULE** underneath all these old sayings and religion - **THEN YOU GET TO HAVE THE FUN OF MAKING ALL DECISIONS FOR YOURSELF.**

Deciding whether you make the decision inside or wait for someone to make all your decisions outside you, is very much like the old question - Is God **INSIDE** or **OUTSIDE** of you? Those who believe that God is inside your body are really saying that the force which steers waves around can be inside instead of outside your body. This is very kool, because only **STEERING OR NAVIGATING FROM WITHIN** can work - at the moment of death or bliss or ecstasy or enlightenment ( think of being the steering wheel in the center of a lightning bolt). This book is about how you steer around things like tornados and your dream as if they were a bubble - and you had to grab a hold of the vortex from the inside out.

You see, from the point of view of new science, creating matter out of light - is a matter of squeezing something called **CHARGE** ( like being **IN-CHARGE**) into compression. When **CHARGE** (electrical waves) gets all squeezed in one place, it stores up something called **INERTIA**. (Inertia is what happens when you spin a top or a gyroscope - it begins to hold itself in place). This inertia is the definition or principle of what is called **MATTER** or creation. **SO...**

God or the creator is the one who knows how to squeeze or compress CHARGE! Where this gets really kool is when you begin to see how your heart and your head learn how to squeeze or collapse waves of this CHARGE. Because this creates the centering force which turns intense ATTENTION into RAPTURE AND BLISS AND ECSTASY AND ENLIGHTENMENT.

**What is the real MEANING of SELF-EM-Powerment?**

How can your aura begin to STEER itself - like an egg with a twister inside...?

Your aura becomes able to make its own choice of direction - just like a tornado does. Tornado's are famous among weather-people for choosing to steer around to prevent killing people. This means that they are SELF-AWARE. The tornado becomes self-response-able (responsible) when - it learns how to FEED ITSELF. It learns the symmetry turns required to turn inside out and feed itself. At that moment it becomes SELF-AWARE.



We will see later that this symmetry SLIP-KNOT recipe for turns (like learning to tie your own bow tie) - creates the heart of hydrogen (in all atoms) - the heart of all people (the heart muscle) AND - the heart of the sun. Pretty kool slip knot eh?

**As Sun's Heart Implodes, Spin Density There Quickens Human Hearts and Each Atom!**

**SUN'S HEART 1878 Heart of The Sun**

**7 Spins Outside**

**7 Spins Inside**

**5 Spins**

**(ANU) Ultimate Physical Atom**

**5 Anu/Quark**

**7 Spins of tetra sort photon donuts into 7 color rainbow color is phase tilt calibrated by cone**

**COLORS/FACES/PHASES.**

**see 5 in dodec cubes**

**5 spin inside**

**7 Spins Outside**

**5 Spins Inside**

**Phi Spiral 5 Spin**

**The Heart Muscle's 7 layers are exactly tilted according to the 7 axes of the tetrahedron, ("Fields of Form").**

**The 7 color electrical donut which electrifies the heart has a tilt which programs the primary muscle. This casts shadow flame at**

**on this letter the center of the heart.**

**The resultant sonic harmonic tensors, are the cardiac rhythms which program thymus, immune, EEG, and related ladder of emotion.**

**The heart sounds are phased in Hebrew to feed mem(oru)-brain**

**Perfect Recursion Symmetry for Slip Knot becoming Self-Organized Implosion**

**HEART MUSCLE AS FLAME LETTER. AN ELECTROCHEMICAL RITUAL TURN?**

The "Slip Knot" Of perfect Fusion appears to be The Same Gordian Knot In the 'Anu' coeur of Hydrogen, in the Human Heart, and in the heart Of the Sun as seen clairvoyantly By Babbitt & others.

The fire of life itself lies in the symmetry

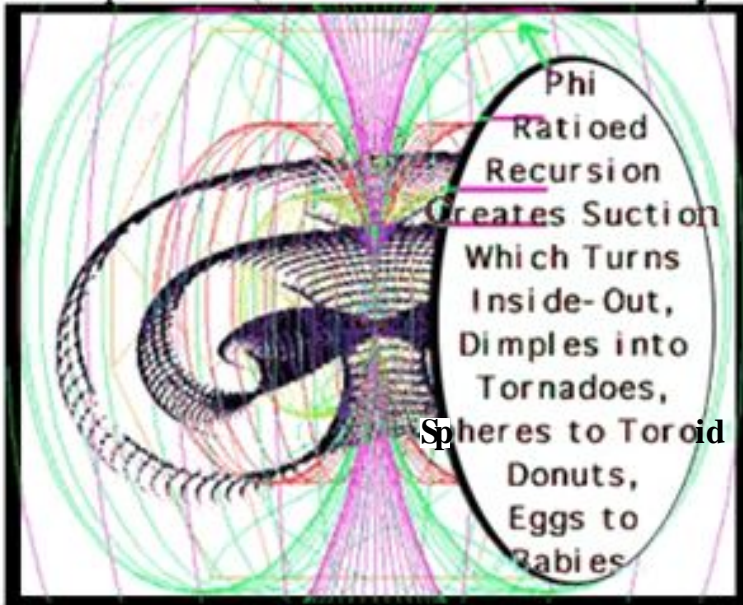
Operations Which make this Self-organizing IMPLOSION Self sustaining...

We look now at Why implosion...?

**ANU: Heart of SUN, HUMAN, & HYDROGEN**



When you DO learn to squeeze CHARGE into yourself with success - that (BLISSFUL) ATTRACTIVE ABILITY is the difference between being SELF STEERING FROM WITHIN - versus always needing something outside yourself to steer you (ADDICTION). This is because you steer your aura or bubble in BLISS or in a dream or at death - just the way a jellyfish does.-- that is by controlling the direction of sucking and pushing in a vortex (tornado) ! Once you learn how to make your own vortex tornadoes of charge attracting into your heart - YOU BECOME SELF STEERING AND THE very PRINCIPLE OF CREATION! ( and the extra benefit is this is the end of your need for parasites and addiction - and the end of believing you cannot steer the world, and the end of waiting to be steered by something outside you)

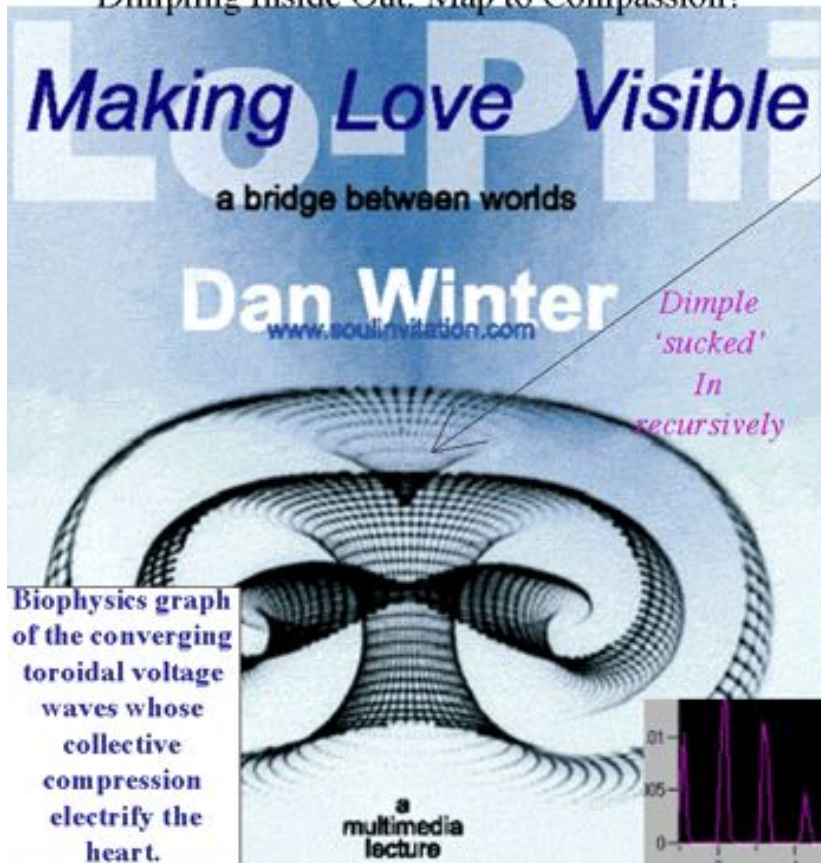


Turning Inside-out again and again (called recursive) - creates SELF-AWARENESS.. because it creates self steering! It happens when the Inside (of your heart) becomes SELF-SIMILAR (holds a real picture of someones feelings OUTSIDE). In emotion this is the true SHAPE and ORIGIN of COMPASSION (- perfect COMPRESSION!). In Science and Math - this shows as GOLDEN MEAN (.618) in the music coming from the heart. This is called the musical key signature of BLISS - FUSION - IMPLOSION .. the neat stuff this book is about.

. Making a picture INSIDE your heart which is "SELF-SIMILAR" -that is a real shaping- to what is outside (someone elses FEELINGS have

a real shape you can create inside) .. THIS IS COMPASSION - and THIS makes the "Fractal Attractor" which is the rush you feel - that draws the outside in. (Perfect Compression).

Dimpling Inside Out: Map to Compassion?

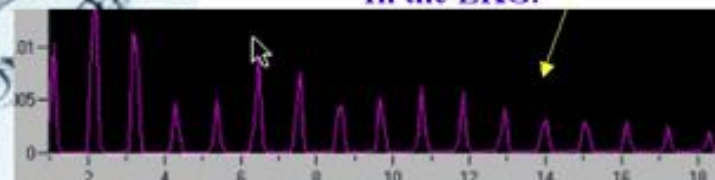


Compassion is learned  
When the little picture inside  
Your heart becomes  
So 'self'similar' ( or 'fractal' )  
To the shape of magnetism  
In someone else -  
That perfect compression -  
The 'fractal attractor'  
Sucks the Out-Side - IN !

This RECURSIVE -  
TURNING INSIDE OUT -  
Becomes IMPLOSION -  
Which is the electrical  
RUSH associated with FEELING.  
And shows up in the ASCENSION  
Of the next harmonics measurable  
In the EKG.

Biophysics graph of the converging toroidal voltage waves whose collective compression electrify the heart.

a multimedia lecture



See the deep interconnectedness of all things  
where even your feelings have a direct influence on the environment  
This becomes visible in music of the Heart using HeartTuner heartcoherence.com

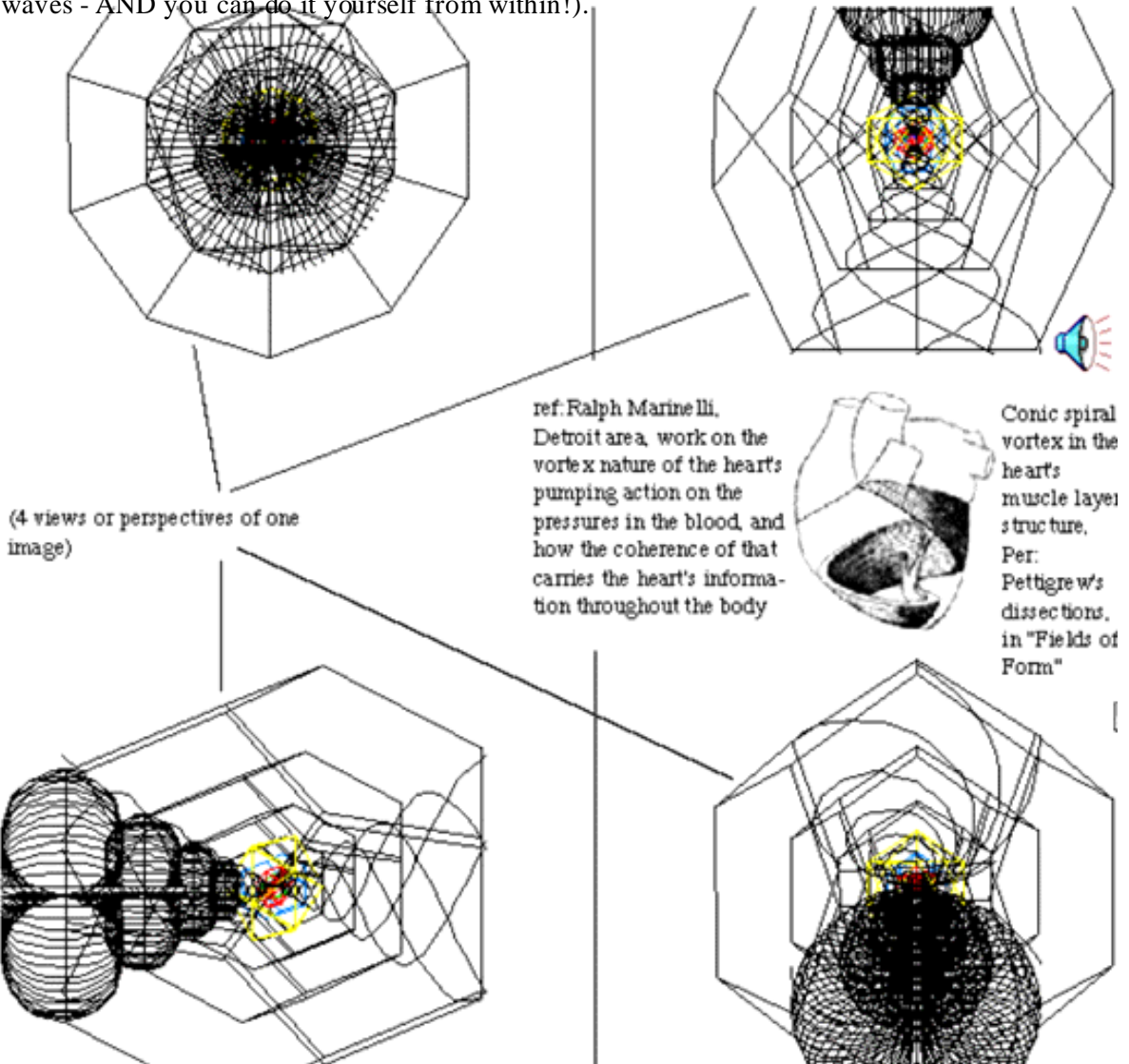
**Is this book about RELIGION? ( Are we going to step on the toes of your favorite Religion? )**

This book is definitely NOT about religion. There is one area that religion and this book have in common however. Religion talks about BLISS (using different terms like ENLIGHTENMENT , SAVING YOUR SOUL, BEATITUDE, SAINTHOOD etc.). This book also talks about bliss. There is one important difference however. This book uses ONLY SIMPLE SCIENCE to talk about these things - ENLIGHTENMENT and even IMMORTALITY - as the result of SPIRITUAL WORK.

Take for example the Christian Church plan that says if your body never starts to smell after you die - then you are a saint. Now we know exactly why in fact certain bodies do not decay after death. The reason is simple - those bodies were more successful at attracting these waves of charge. As a result - the process of sucking in this life force - prevents the cells from decaying (rotting and smelling - part of the not so fun aspect of dying). We now know how to teach these principles of how to make your cells into better holders of charge (things like live food and so on, which we get into later). So if you do all these things right about really glowing with this charge (which include thinking very SHAREABLE ideas - feelings which are loving) - then your cells will truly stay happy and glowing even after death. The thing is - the process of becoming sustainable (immortal) is a science of charge - and should not be called a mystery - because IT IS NOT A MYSTERY! Once you stop worshipping miracles and instead understand their principles - you become powerful and take control - instead of becoming food for parasites.

There are some who would say that if you subtract MIRACLE WORSHIP and PERSONALITY WORSHIP from RELIGION - the only thing left is practices to make BLISS. This may be true. After you read this book, we will suggest you decide whether to reduce the amount of MIRACLE and PERSONALITY worship in your life. Once you discover for yourself the PURE PRINCIPLES or RULES behind how waves in SCIENCE MAKE BLISS FROM WITHIN - you might decide you don't need to worship some mystery or person outside of you. Rather - you can simply go inside - AND BE THE DREAM! (because you understand how creation really works among waves - AND you can do it yourself from within!).

“Come On  
Baby-Light  
My Fire...”  
The Heart is  
“PHIre’d” by  
an Implosive  
Symmetry  
Array of  
Voltage  
Donuts -  
Which Learn  
Compression  
which  
IS  
Compassion  
& Key to  
Implosion..





**CHAPTER TWO: So how does creation really work - in simple terms - and what does this have to do with me making bliss and ecstasy and enlightenment??**

Let's do this in 2 parts. First let us ask waves how they create matter out of light. Then let's ask what is bliss and ecstasy and enlightenment.

First - why should you want to know HOW creation happens? Why should you care about deep science or physics? What does this have to do with getting bliss and enlightenment?

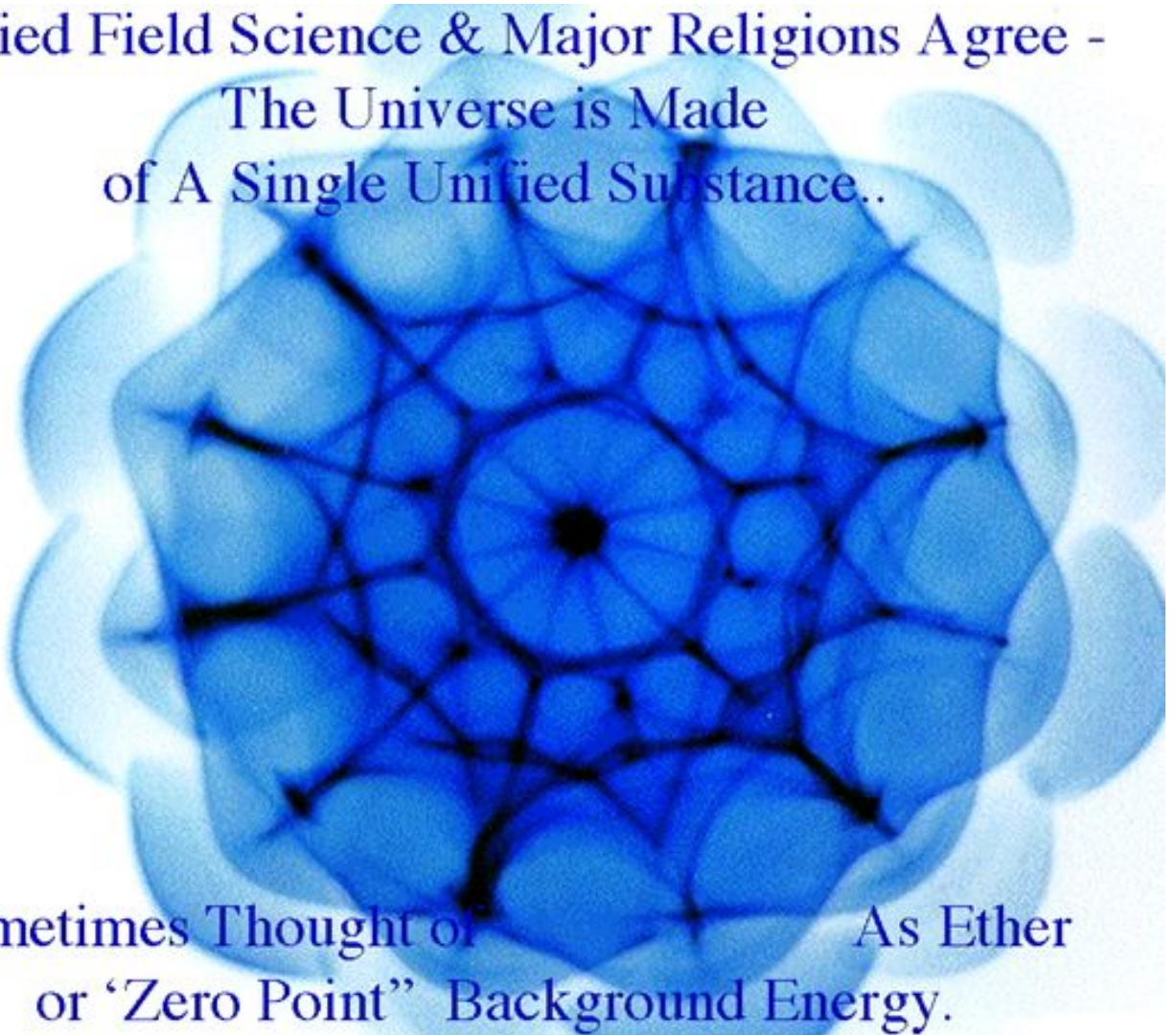
Well, science has recently gotten turned on to the idea that there is a simple shape of waves - which allows all parts of the science of waves and matter to be gathered into ONE great simple whole picture. The PATTERN or shape for waves- reflecting off each other - the name: SYMMETRY. - this word means: "It's all done with mirrors!".

Symmetry for example talks about whether one side of your face is an example MIRROR image of the other side. Symmetry for waves is deep and important because only when waves bounce in symmetry do they stay alive. Scientists agree that creation is entirely about symmetry. If rules and principles about symmetry were put together - they SHOULD be able to explain everything in science in ONE single system of waves. And the name they give to this idea that there is one rule or principle that brings all the different parts of science together - is called THE UNIFIED FIELD.

By this they mean that there is a way to see everything you observe as an unpacking of one simple rule happening inside one common substance or field ( or set of waves). When we talk about one common substance or field - think of the universe as one HUGE bowl made out of only one kind of jello -which wiggles a lot - as many different WAVES move around bumping in to each other.

**Unified Field Science & Major Religions Agree -  
The Universe is Made  
of A Single Unified Substance..**

**Sometimes Thought of As Ether  
or 'Zero Point' Background Energy.**



Different sizes and speeds of these waves have been called LIGHT and ELECTRICITY and GRAVITY. The big problem of science and physics has been to figure out how THESE different shapes of waves (light, electricity, gravity and so on) - COULD in fact be all made up of only the same unified stuff - or substance.

For example - you might have heard that there is a way to see light and electricity to be made of all the same

exact stuff - just vibrating slightly differently.

But did you know - that there is a way to see electric-ity & light - to be made of

exactly the same stuff GRAVITY is made out of!

It is actually kind of neat - that even scientists who you could think usually weren't smiling a lot - actually call this UNIFIED FIELD problem- THE HOLY GRAIL OF PHYSICS.

You see - Einstein - the most famous scientist - PLUS most every great religion have

always insisted that the universe IS in fact ONE SUBSTANCE. The problem is that

Einstein and all the great religions have not yet been able to work out the details of the rule that explains HOW the universe could be made of ONE thing only.

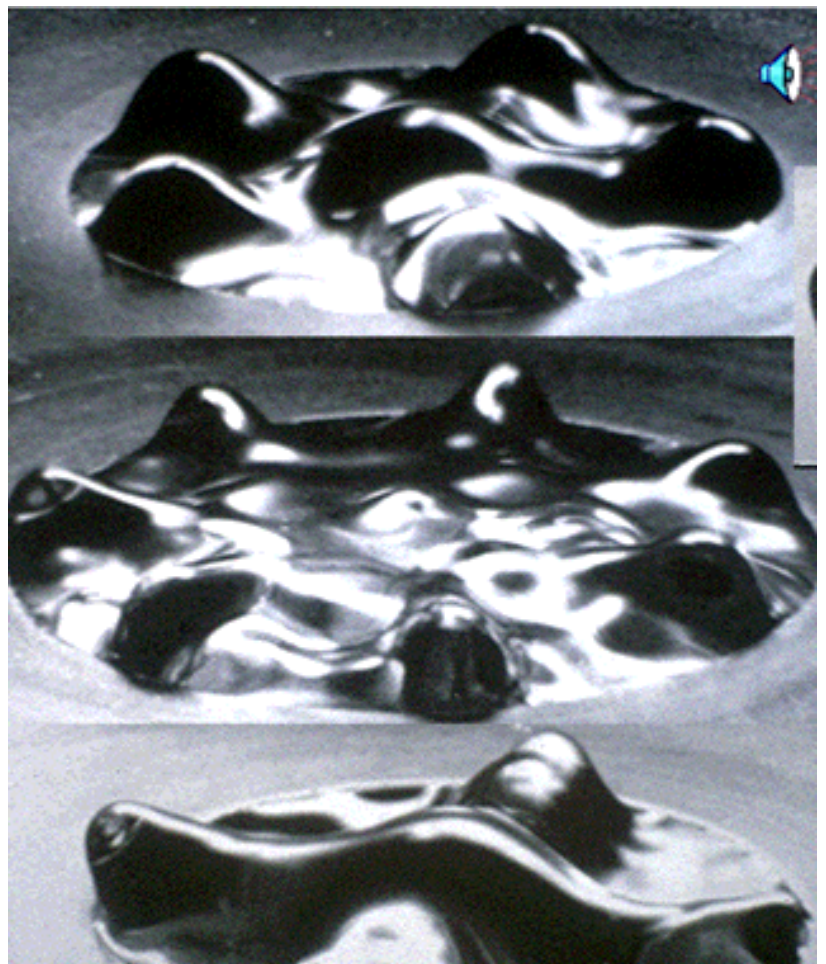
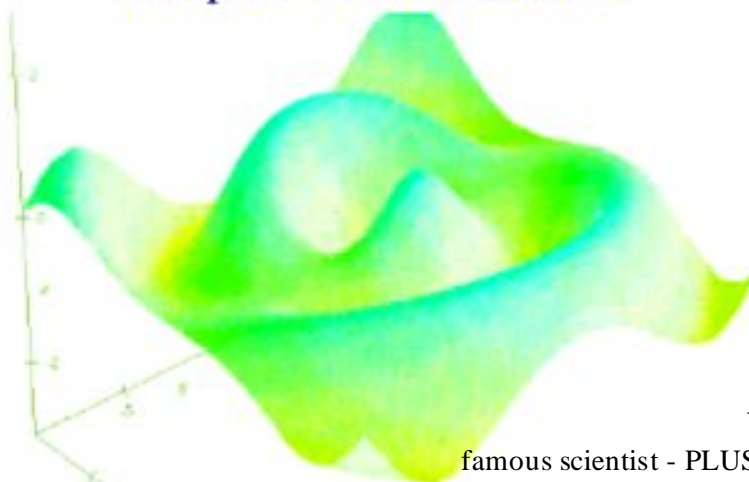
--

### SECRET OF THE ATOMS AND CREATION OUT OF DONUTS

Waves begin to store their pattern by going in circles. They notice that the only waves that survive and continue are the ones that keep returning to the same center. This need to keep finding one center - for waves - produces the one thing that waves make when they self - organize.. a smoke ring - a donut.

Each donut is made of two tornadoes or twisters or VORTEX. This is like two light cones that meet in the center. Later the amount of spin INERTIA stored in each vortex is called an ELECTRON.

## This Universal Medium or 'Ether' is a Compressible Fluid Like Substance Which By Storing 'INERTIA' ..Like Waves in Jello - Becomes - Electrons, Photons, Atoms, Molecules, People, Galaxies etc...





Sine Waves Revolve  
to become donuts...  
Sine Waves as 3D Donuts  
are the 'Toroidal' Vortex  
Or Wormhole or  
String Nature  
of Physics Today

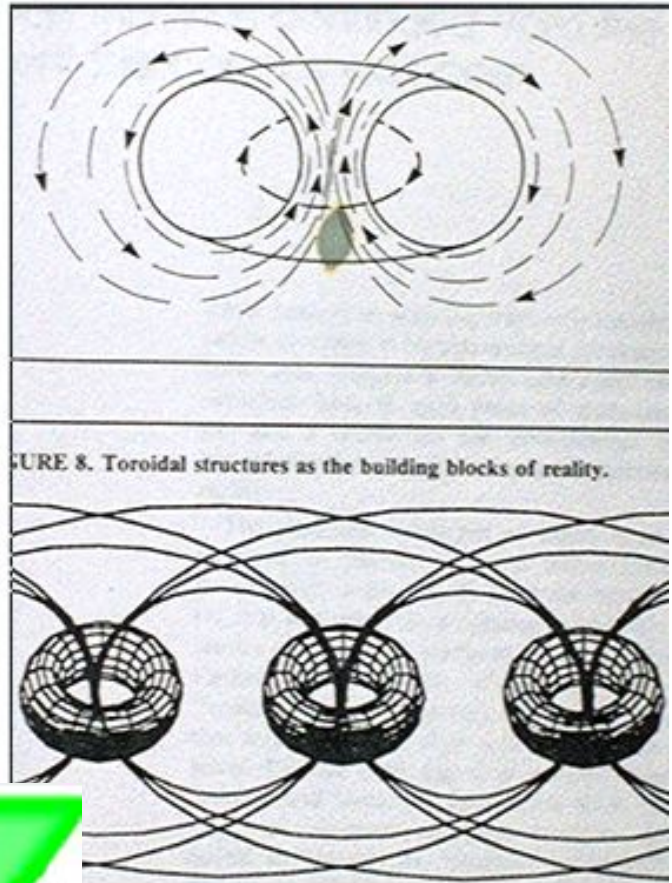
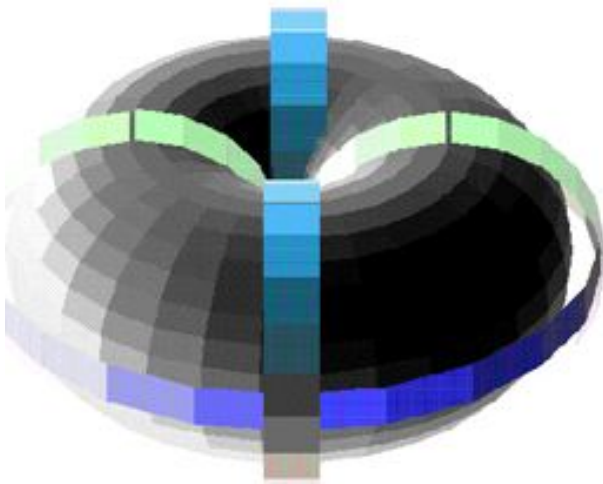
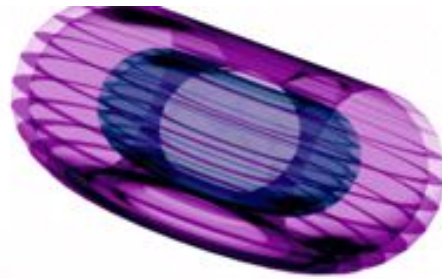
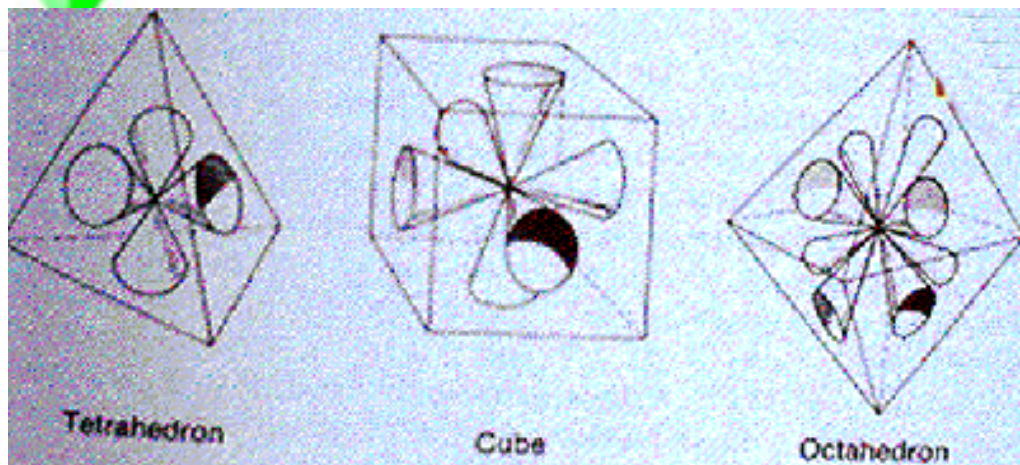
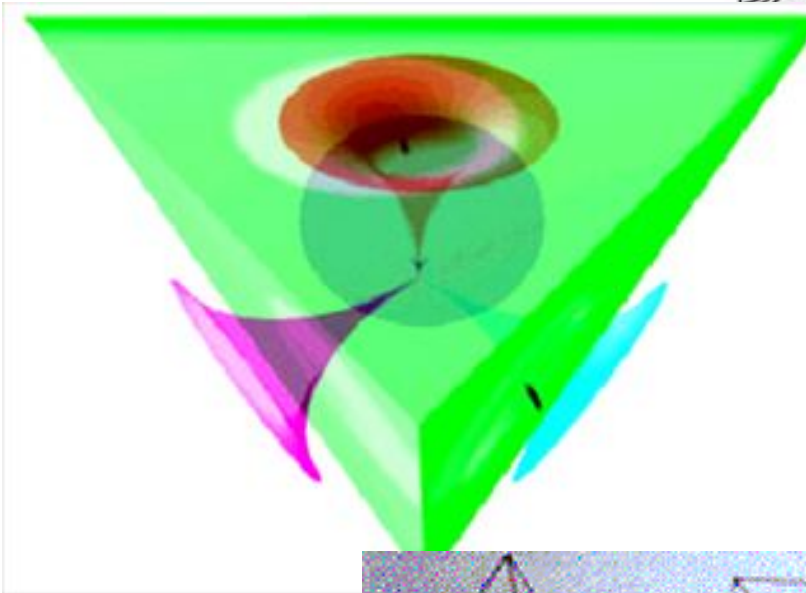


FIGURE 8. Toroidal structures as the building blocks of reality.

Later - these vortex pairs (pairs of tornados nested) discovered the only way they could survive when they were compressed together - was .. TETRAHEDRON - CUBE - OCTAHEDRON and so on.

This is how the PLATONIC SOLIDS ( these shapes) AND - the ATOMIC TABLE. (All the elements- everything in matter) were formed.





When these tornado twister vortex things nest this way- science started adding up the amount of INERTIA in each cloud of their spin.

There are 2 twister vortex in ONE donut.

3 pairs of these (6) make a cube.

5 Pairs (10) nest in a DODECAHEDRON

7 Pairs (14) in an ICOSAHEDRON.

:Later on when you study CHEMISTRY remember this- because you will be the only one in class who knows WHY nesting 2,6,10 and 14 ELECTRONS makes the whole TABLE of the ATOMS! You can even now know how CHEMistry and alCHEMY got their name.

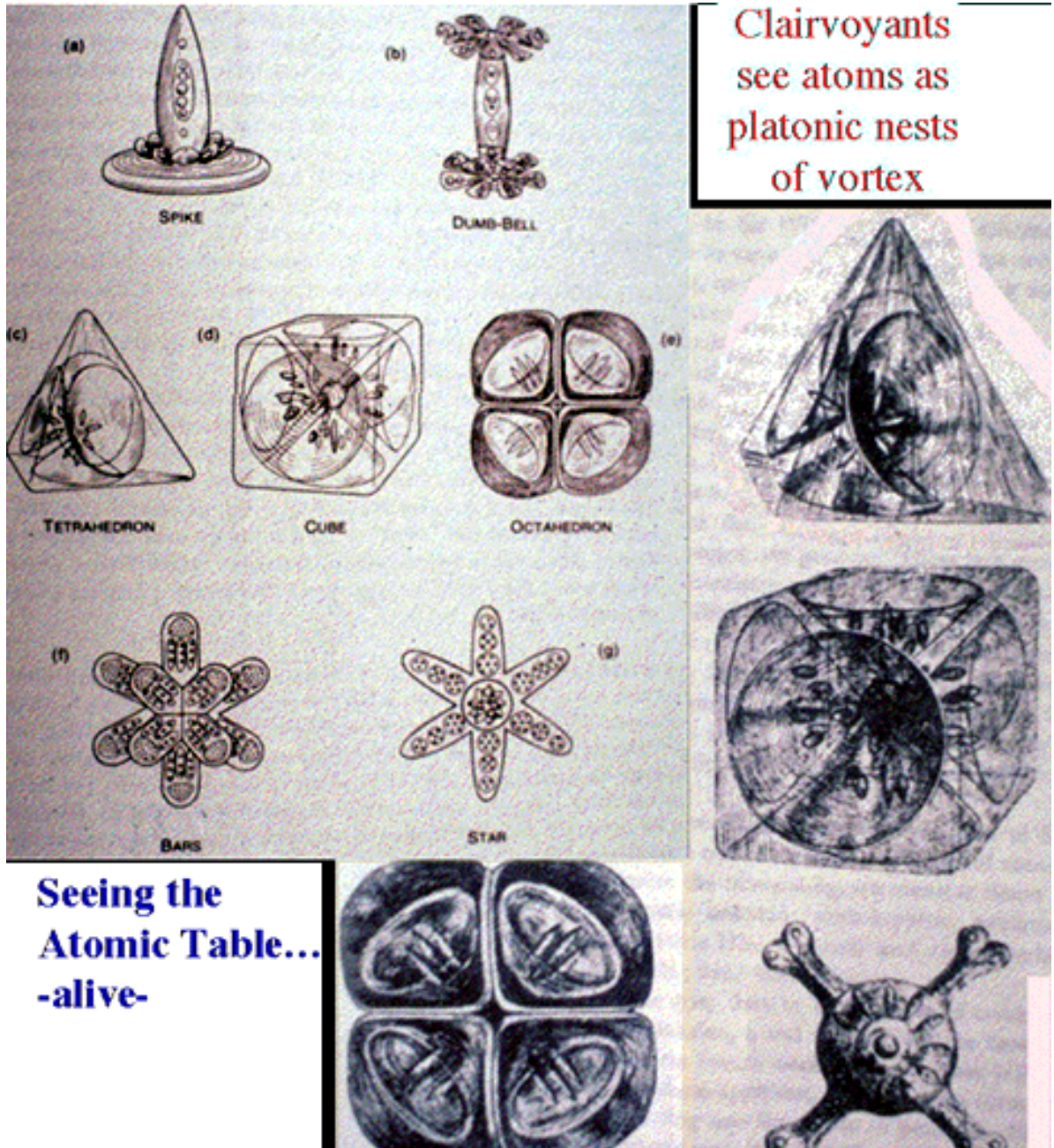
Khem was the original name for Egypt. Khem means the place of BLACK-ness. It was named this because the leader - Thoth / Hermes (son of Enki - the RA in ab-RA-ham ) - had dark or black nubian skin. His blood was blue black because he was from Rigel in Orion. This becomes the reason Mary was called the BLACK madonna - later - (his children).

You can read the whole story - Return of Enki - at [goldenmean.info/enki](http://goldenmean.info/enki)

Back to our story of the origin of KHEM-istry and al- KHEM-y.

They are named because these are the study of how charge makes BLACK holes! (That is what IMPLOSION and vortex have to do to make Gravity as we shall see). GOLD -the heart of ALCHEMY - for example arranges these ELECTRON shells into a perfect 3D FRACTAL. (Icosa and Dodeca). And so GOLD is a perfect way to suck charge into a black hole! GOLD plays a key role in the story of our ancestors genes as we shall see.

So this should get you interested in the PICTURES of how these vortex light cones - nested in 3D like GEOMETRY - make ALL THE ATOMS! Science teachers are correct when they teach you about waves of charge making atoms in CHEM-istry. BUT - by not showing you enough pictures - usually they don't tell you that your mind - made of implosion among the same waves- was designed to be STEERING those TORNADOS.



Clairvoyants see atoms as platonic nests of vortex

Seeing the Atomic Table... -alive-



It Angle Among Fields, Translates the Alphabet of Symmetry, into The Atomic Table. of The Periodic Law (after Crooks)  
 The shape known as valency, is the platonic solid field nesting of the electron shells, which determines bond (phase) angles. creative symmetry among  
 "Geometric Factors in Nuclear Structure" Lawrence Hecht, Fusion Magazine, "Occult Chemistry" Leadbeater/Besant, "Psi Perception Quarks" Phillips

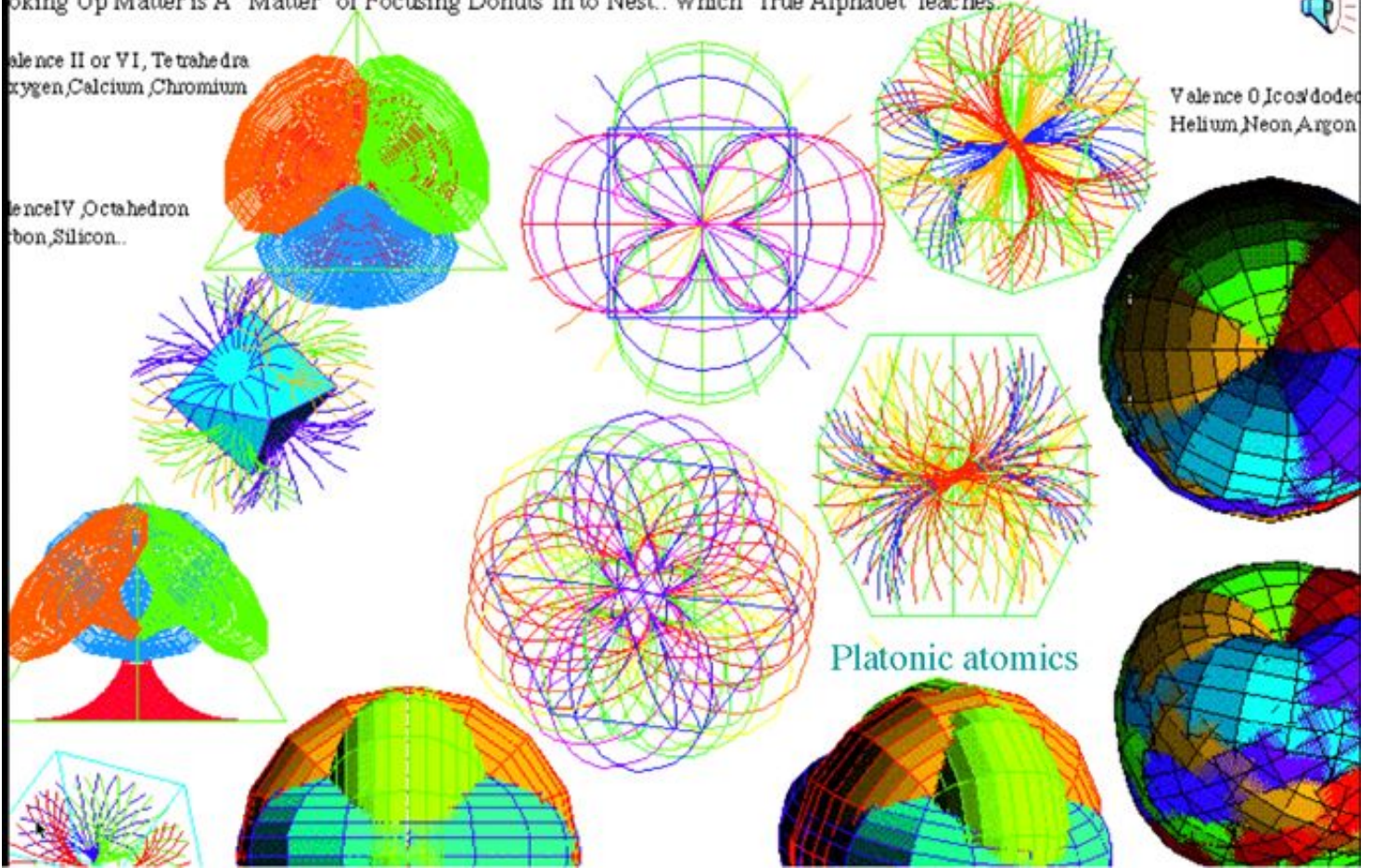
Looking Up Matter is A "Matter" of Focusing Donuts In to Nest. Which True Alphabet Teaches.



Valence II or VI, Tetrahedron  
 Oxygen, Calcium, Chromium

Valence IV, Octahedron  
 Carbon, Silicon...

Valence 0 Icosahedron  
 Helium, Neon, Argon



Platonic atomics

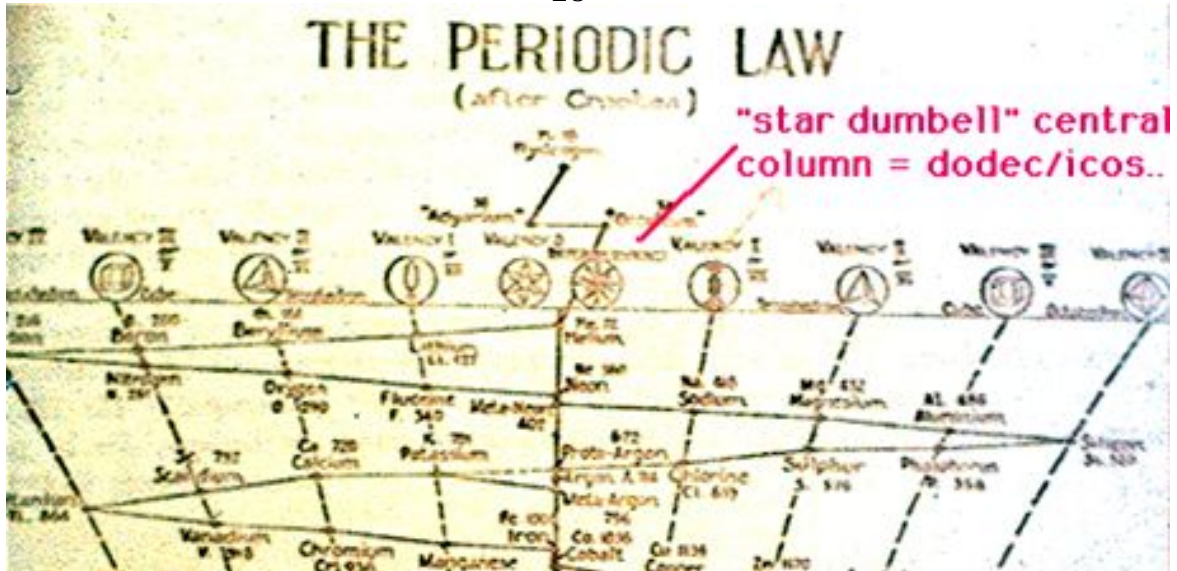
If you could really see inside matter for yourself- you might see what clairvoyants see. (people who see auras)  
 The Theosophy group Leadbearer who saw atoms work (pics on left) was later proven in SCIENCE! ("Psi Perception of Quarks" by Phillips). Understanding how waves nest naturally by simple geometry gives you the keys to move them - from inside your own heart.

### Atomic Table Arranged PLATONICALLY (by 3D Solids)

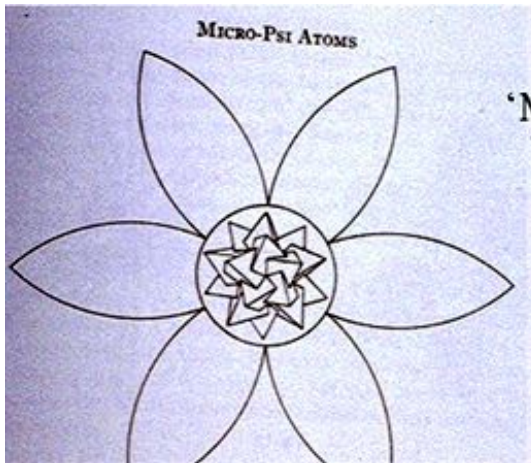
		Tetra		Cubic		Octa		Dodeca	Icosa
SPIKE GROUP	DUMB-BELL GROUP	TETRAHEDRON GROUP		CUBE GROUP		OCTAHEDRON GROUP		BARS GROUP	STAR GROUP
		A	B	A	B	A	B		
IA Lithium	IA Sodium	IIA Beryllium	IIA Magnesium	IIIB Boron	IIIB Aluminium	IVB Carbon	IVB Silicon	VIII Iron	0 Neon
VIIIB Fluorine	VIIIB Chlorine	VIB (Oxygen)	VIB Sulphur	VB (Nitrogen)	VB Phosphorus	IVB Titanium	IVB Germanium	VIII Cobalt	0 Argon
IA Potassium	IB Copper	IIA Calcium	IIIB Zinc	IIIA Scandium	IIIB Gallium	IVA Zirconium	IVB Tin	VIII Nickel	0 Krypton
VIIA Manganese	VIIIB Bromine	VIA Chromium	VIB Selenium	VA Vanadium	VB Arsenic	Ln Cerium	Ln Terbium	VIII Ruthenium	0 Xenon
IA Rubidium	IB Silver	IIA Strontium	IIIB Cadmium	IIIA Yttrium	IIIB Indium	IVB Hafnium	IVB Lead	VIII Rhodium	"Kalon"
VIIA Technetium ("Masurium")	VIIIB Iodine	VIA Molybdenum	VIB Tellurium	VA Niobium	VB Antimony	IVA Thorium		VIII Palladium	0 Radon
IA Caesium	Ln Samarium	IIA Barium	Ln Europium	IIIA Lanthanum	Ln Gadolinium			Elements "X," "Y," and "Z"	
Ln Promethium ("Illinium")	Ln Erbium	Ln Neodymium	Ln Holmium	Ln Praseodymium	Ln Dysprosium			VIII	
Ln Thulium	IB Gold	Ln Ytterbium	IIIB Mercury	Ln Lutecium	IIIB Thallium			VIII Iridium	
VIIA Rhenium	VIIIB Astatine ("85")	VIA Tungsten	VIB Polonium	VA Tantalum	VB Bismuth			VIII Platinum	

Electron Valence Symmetry

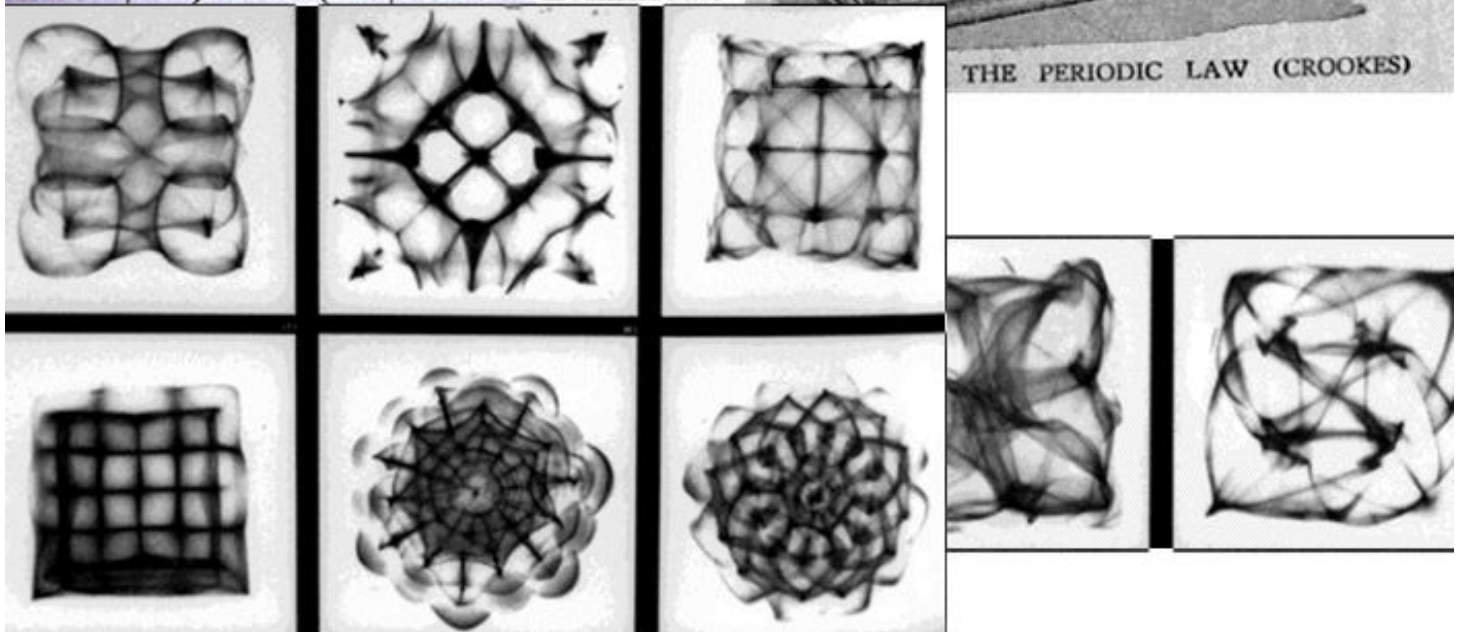
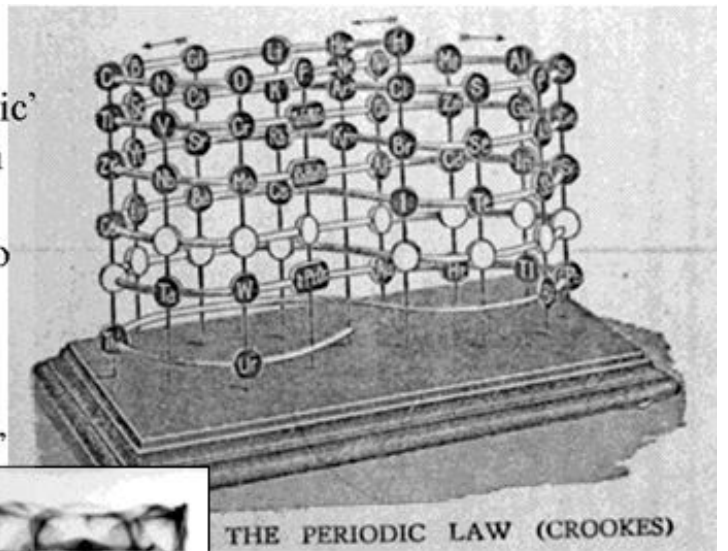




So - matter got made when vortex clouds learned to focus. This skill to focus and compress charge is the secret of CREATION and how you get to steer tornados.(all of matter). The way in which charge waves get to be compressed -to store the inertia we call matter or mass - is called PRECIPITATION. Later we study how to make rain. It is always the wave pattern of IMPLOSION that starts the COMPRESSION and HEART MAKING - DIMPLE - process. This is how MIND arises out of WAVES.

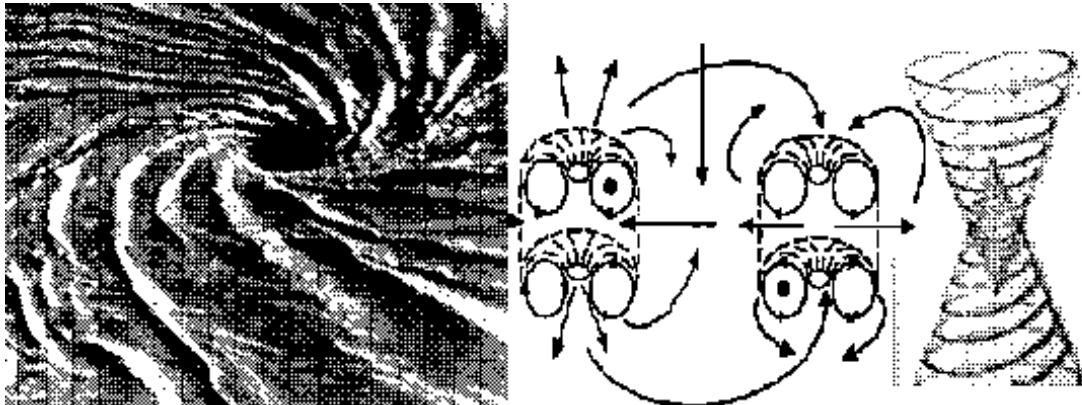


Cymatic  
'Macrodynamic'  
Wave-Form  
Shadows  
Compared to  
Atomic  
Table:  
"Platonic  
Lemniscate"





-It was SO important to learn how to focus twisters to make donuts. This makes creation. So we had to learn a way to compress charge inside. This process of taking the outside - into the inside - is called MAKING A



SYMBOL.. The purpose of making a SYMBOL is to “EMBED” the outside shape of waves - inside you.

When done properly - then the wave picture you make inside you - becomes SELF-SIMILAR (identical) to the wave picture outside you. In science the best way to compress charge for a wave is - you guessed it - THE GOLDEN MEAN SPIRAL.

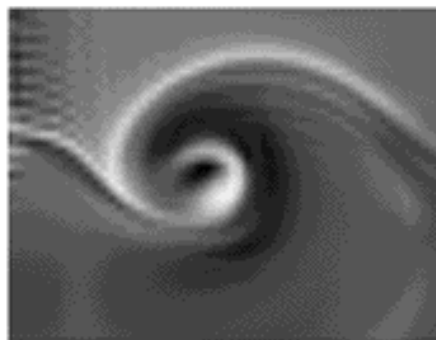
The Golden Mean spiral is the only angle at which a wave can enter itself without hurting itself. This is called SELF RE-ENTRY. The ability to re-enter self for a wave is called SELF-REFERENCE. This simply means the ability to REFER TO YOURSELF. The ability to SELF-REFER is the definition of consciousness (The Vedas). This is why the Golden Mean spiral base for waves compressing - is the origin of CONSCIOUSNESS (self-reference)- and the origin of CREATION PRINCIPLE ( perfect way to COMPRESS charge waves)

**Implosion Exists Because In The Geometry of “SELF SIMILARITY”  
- It is Possible for a Wave to Re-Enter ITSELF - Non-Destructively.**

**Ability to SELF-REFER  
is the Vedic definition of CONSCIOUSNESS.**



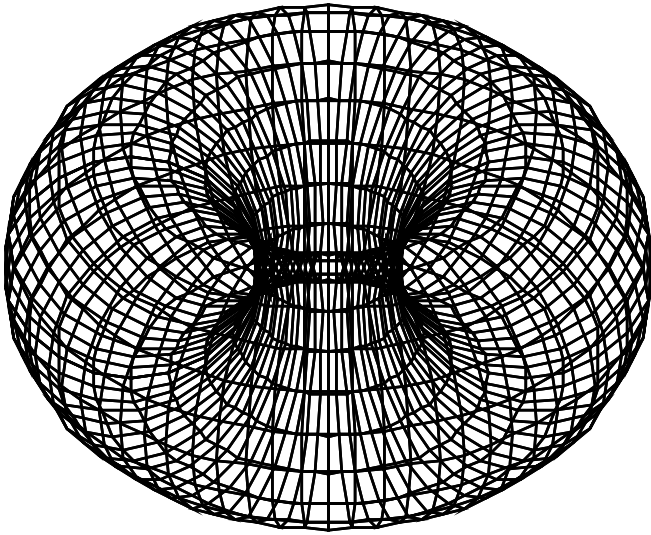
The GOLDEN MEAN  
SPIRAL  
Is Self-Similarity  
Perfected  
For Wave Mechanics



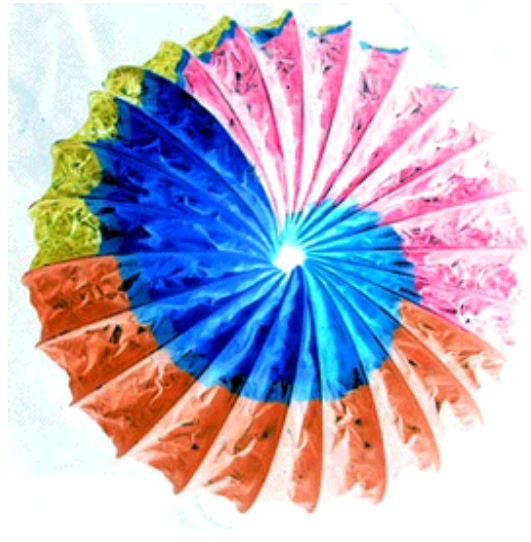
In Hydrodynamics- This is called:

“Optimized Translation of Vorticity”

It means - this is the only way for Inertia in a line to be “translated into a circle”. Since the inertia created by waves in rotation is the ONLY definition for MASS - this translation is by definition the perfect path from MASS to ENERGY. **Later we use Spectrum Analysis to Measure This**



Do you see a "Grail" cup in the center of this donut?



Every  
Color  
Touches  
Every  
Other  
Color  
Region..  
Very  
'Touching'

How  
Compression  
Mapping  
Became  
Alphabet

*Golden Mean Spiral ('Yellow Brick Road') Self Organizes on the 7 Color Moebius Donut Torus 'Rainbow Connector'*



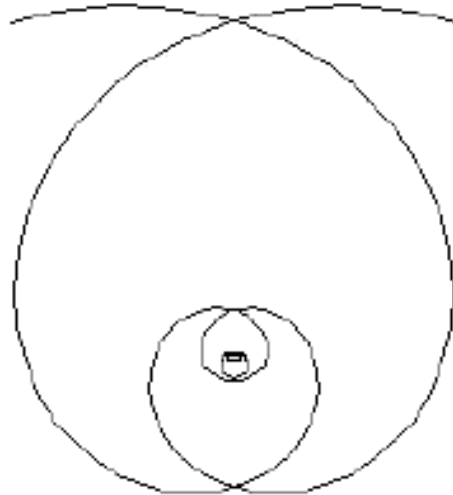
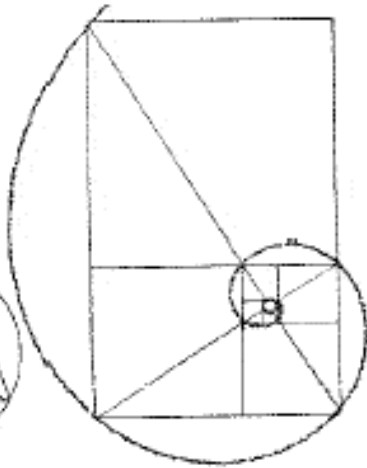
It is easy to see that this golden-mean spiral is also **self organizing**. The universe arranges itself as donuts which are really 3D sine waves. Everywhere sine waves focus, they meet and interfere. The nodes of these wave beats are called "heterodynes". All wave heterodynes combine and beat in only two ways, they **ADD** & **MULTIPLY** as wave lengths. The golden mean spiral progression is the universe's only possible way then for waves to nest without interfering, because it is the only ratio sequence which **BOTH** adds and multiplies! ...

0.618... (and .618... times 1.618... = 1.000  
 +1.000 1.000 times 1.618... = 1.618...  
 =1.618...+ 1.618... times 1.618... = 2.618...  
 =2.618... 2.618... times 1.618... etc....)

Spiraling Triangles,

Spiraling Squares,

Fractal Hearts.



If we wrap seven regions around our donut, we can get each and all of them to touch each other! A 7 color donut....., the real rainbow connection!

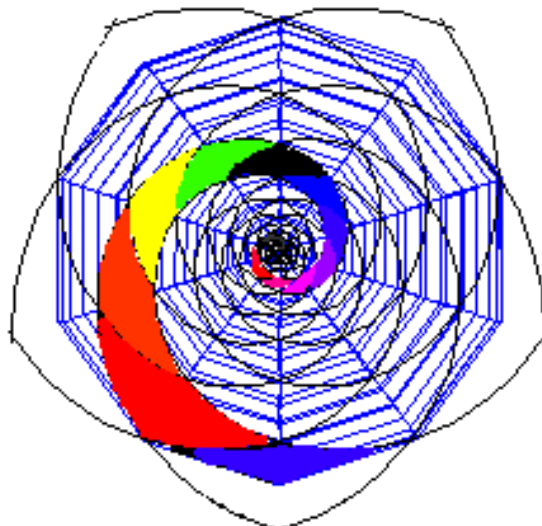
And further, the golden mean spiral traces their boundaries!..

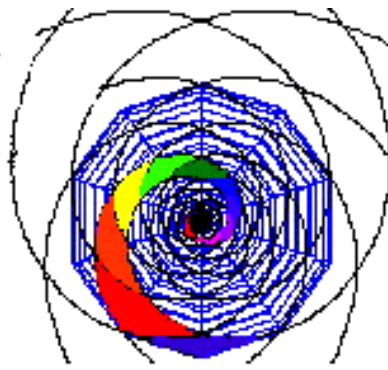
So what we've done is said the universe as a big wave puddle comes up with the donut as the only way to survive. Then the waves come up with the **GOLDEN MEAN**, as the only way to interfere with each other **CONSTRUCTIVELY**. So, pulling our universal selves up by our own bootstraps, we divide or sample (scientists call this quantizing the continuum) the donut **WITH THE GOLDEN SPIRAL**, to solve the seven color map problem.

We're getting close to the origin of the alphabet....

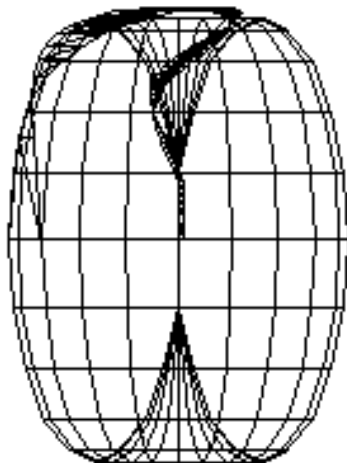
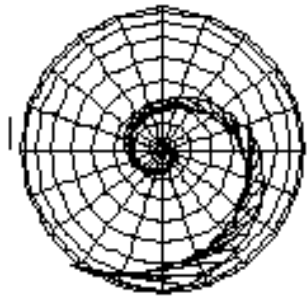


The top view is the same golden spiral map.

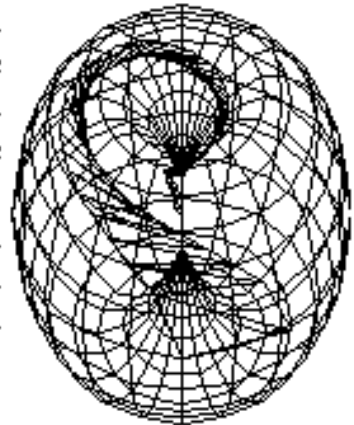




This self-organizing spiral with golden meaning, upon the self-organizing donut produces from 3D to 2D, shadows on the wall of our flatland cave, THE ALPHABET! The alphabet is literally the creative language of light, the bubble domain platonic nest/ atomic table, elements of symmetry.



This is Adam's apple peel, the byte off the apple. By tilting this sample strip to the platonic solid angles of symmetry, the shadows literally are the ancient Alphabet!



Membrane, identity is fed, when the light impression can fuse lock with the fold which is surface. The naked membrane takes cover (weaves a ray-ment of many colors) with the fig leaf.

Aleph



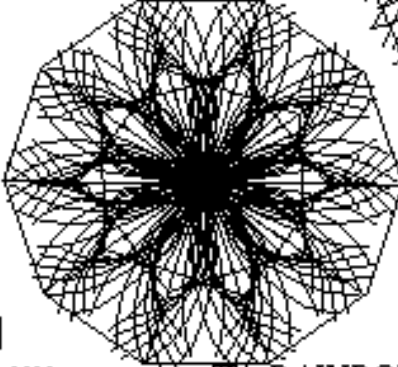
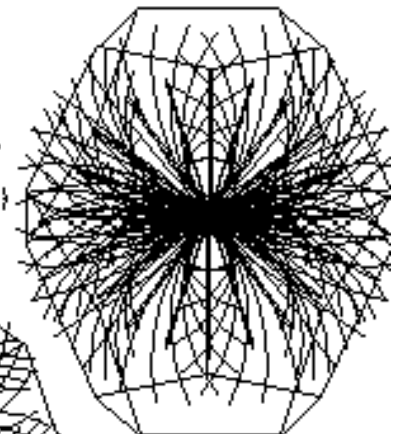
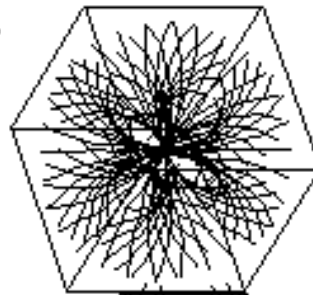
Bayt



Ghimel



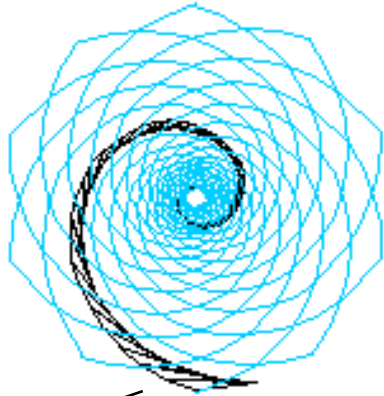
The ABC's of symmetry, which permits donuts to nest, turns out to be the alphabet itself! We are offering modeling tools to teach the origin of geometry--and language, in the autogenic (& photogenic) donut.



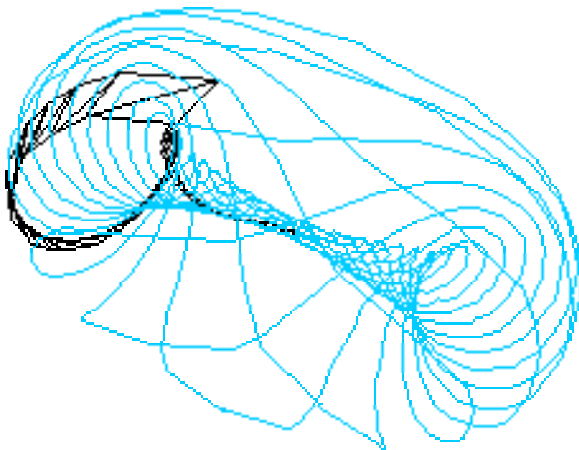
The RAINBOW CONNEXION donut, comes stunningly hand painted in the bright 7 color map, all regions touching all other (it's very touching).

The delinator strip is a moving GOLDEN spiral. The model is about 7" across, constructed of a spiral flex material and coloring specifically to turn inside out upon itself endlessly. As you turn it thru itself the gold spiral comes alive. It teaches the fundamental principles of topology, recursion, and self-embeddedness. It is so irresistible... it may be the ultimate metaphor for matter. (deep enough in which to lose yourself in ORDER to find yourself).

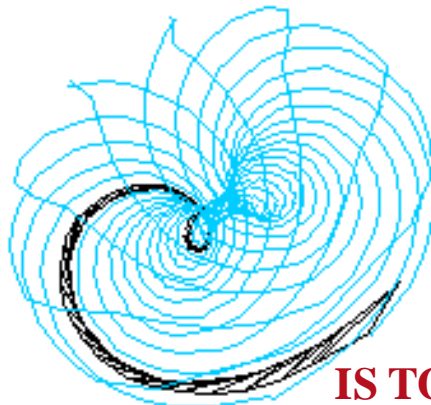
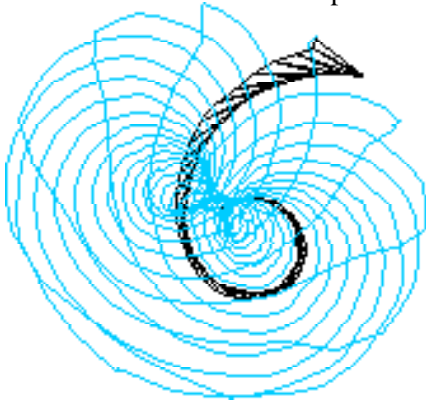




Golden Mean spiral wrapped around donut, top view



other views make an alphabet of symmetry.. angle-ish.



**In original words:  
TO SYMBOLIZE  
IS TO EMBED (nest inside).**

**To Symbolize is  
to MAKE COMPRESSIBLE -  
because  
symbolizing is the process  
of taking INSIDE you  
what WAS - OUTSIDE YOU!**

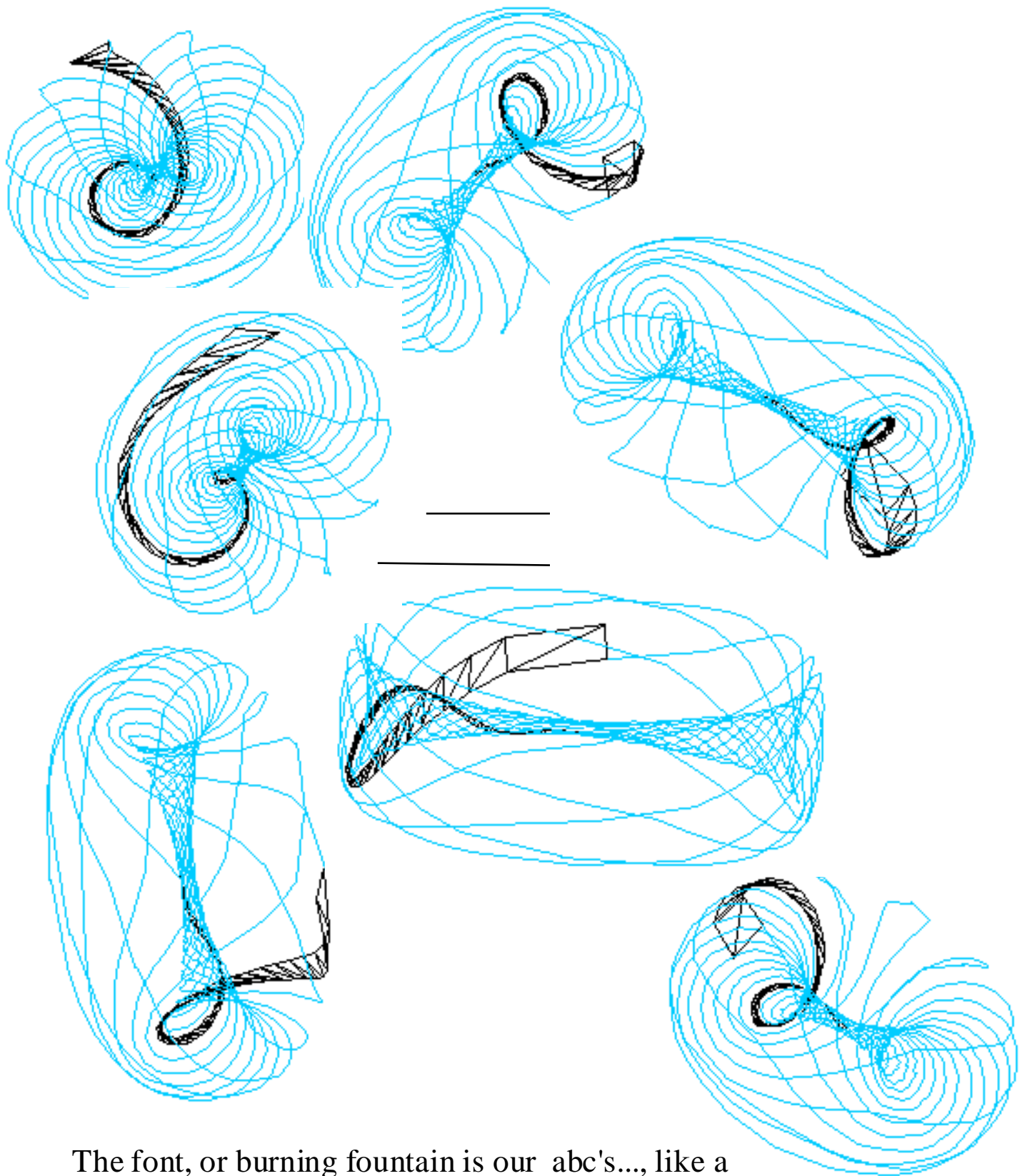
**When the picture inside  
contains all the symmetry  
information of  
what WAS outside -  
then your wishes CREATE  
the world (by the science of  
COHERENCE).**

**The math is clear:  
Golden Mean  
is the perfect tool  
to compress!**

So this is how we got A B C - the letters of the alphabet. We were learning the tilt angles of approaching donut waves (called DOMAINS). By learning how to steer the INERTIA of those waves in compression - effectively - we were learning how to STORE the inertia - therefore creating matter out of light. Alphabet symbols were a way to find your angle quickly to allow you to become the gravity center of approaching tornados. Remember - all of science is made of nothing but these tornados (wormholes, 'strings'). Learning to steer into them - by COMPRESSing well - was what alphabet was designed to do (called - to em-BED ).

For the complete story with playful animating of the origin of the alphabet from the Golden Spiral (called FLAME LETTER) on the donut - see [goldenmean.info/dnaring](http://goldenmean.info/dnaring)

It is important to visualize this clearly so that you can become the creator -the one who uses the tilt symmetry (language) of light. If you dream in the (symmetry tilt of donut fields) language of LIGHT - then your dreams come true! This is because the hologram inside your body starts to fit (lock into) the hologram OUTSIDE!



The font, or burning fountain is our abc's..., like a cookie cutter extruding light domain donut bubbles onto membranes.. memory. These are accurate computer projections of the self-organizing golden spiral delineating the self organizing 7 color symmetry map off the self organizing torus. To make our "font", they are just tilted or "phase locked" into the self organizing "alphabet" symmetry.



From Hollow-gram to HOLO-GRAM: a light lesson in language.

Once there was a lady who's mirror and magnifying glass in her purse were too heavy to carry. She had a scientist change them into a hologram instead. (A hologram is a 3 dimensional -not flat- picture made out of only coherent light).

But when she got home she discovered she could not see HERSELF - in her new mirror and magnifying glass. Only she could see mirrored and magnified other objects INSIDE the hologram.

This is correct science - mirrors in holograms will reflect only things inside and not outside their own hologram.

This is the same problem your visual brain has to make your dreams come true! This is because the way your brain makes vision pictures inside your head is JUST LIKE A HOLOGRAM (see "Holographic Brain" book).

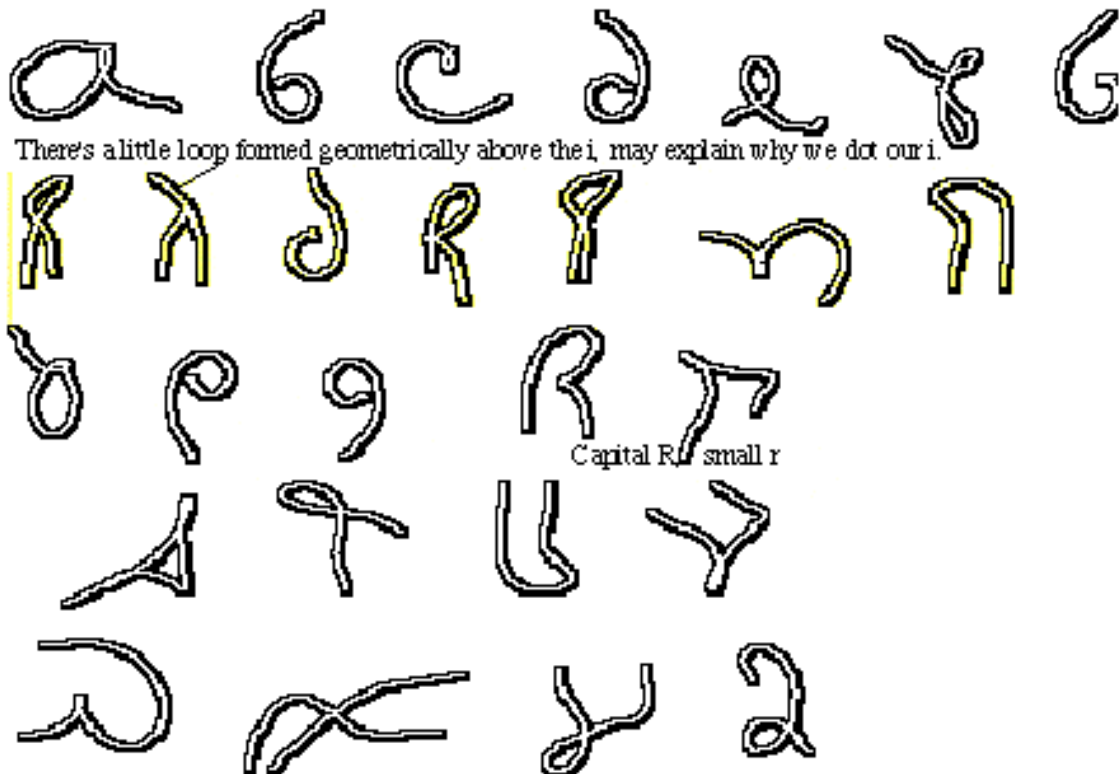
SO how can you get items inside a hologram - sharing energy with object outside the same hologram? This is how to make your visions become true .

Photons are donuts - which when TILTED ACCURATELY - become coherent. You see the pictures here that truly the TILT of these light donuts is exactly what is the ORIGIN OF ALPHABET LETTERS. If you get some of the correct COHERENT light with the same 'tilt' (called 'phase angle') of the ORIGINAL LIGHT used to make the hologram..... then the lady could again see herself in her own mirror! This - origin of alphabets - is truly the way to make the hologram inside you - get in touch with the hologram OUTSIDE your head. MATTER- the word outside the inside of your head- is just a hologram with a weight problem.

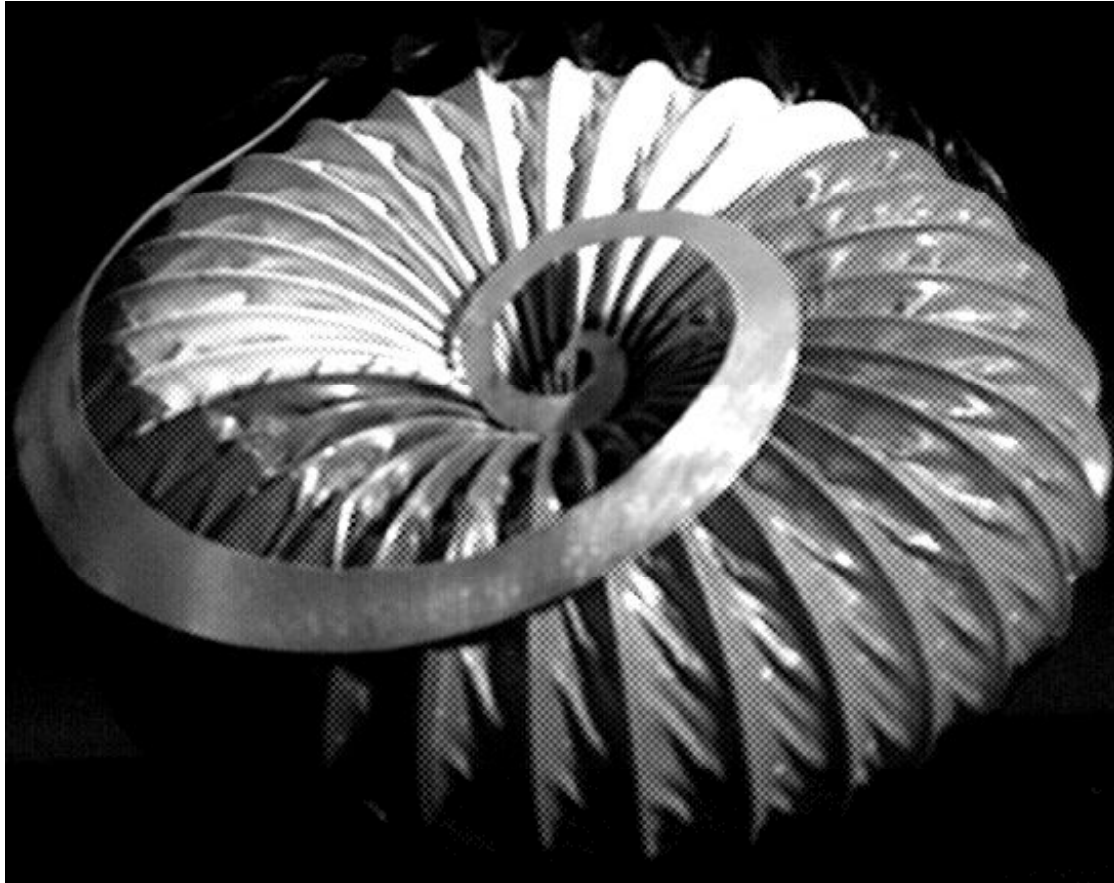
Visions come true the same way charge waves when compressed MAKE MATTER. This is called precipitation - in science and in magic!

What is kool - is that making alphabet letters out of Golden Mean in the best science to compress charge - into 'phase' or into patterns that reach between holograms inside your head!

Alphabets teach your inner pictures or IMAGINATION - to compress charge - and make you the CREATOR!



— Now look again at how this spiral gets the best map off the donut



Notice how views of this sample spiral off the donut, seem like pieces of the alphabet!?

Spiral of the Golden Mean  
laid upon or sampling the donut..



top view,  
it looks like a simple spiral  
on a plane.



side view

front view



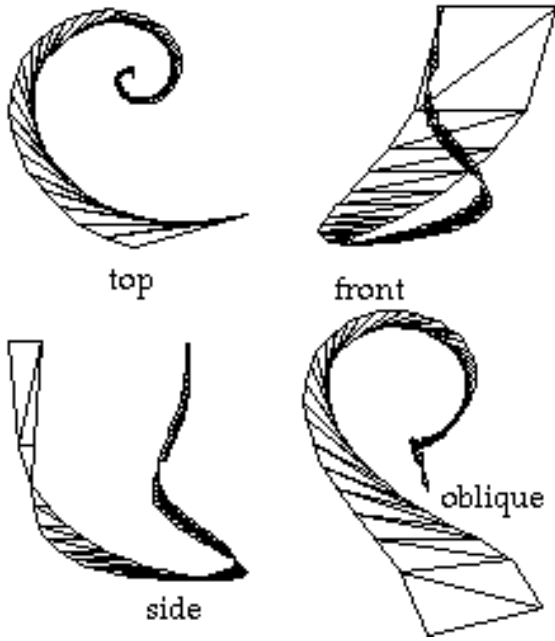
oblique view



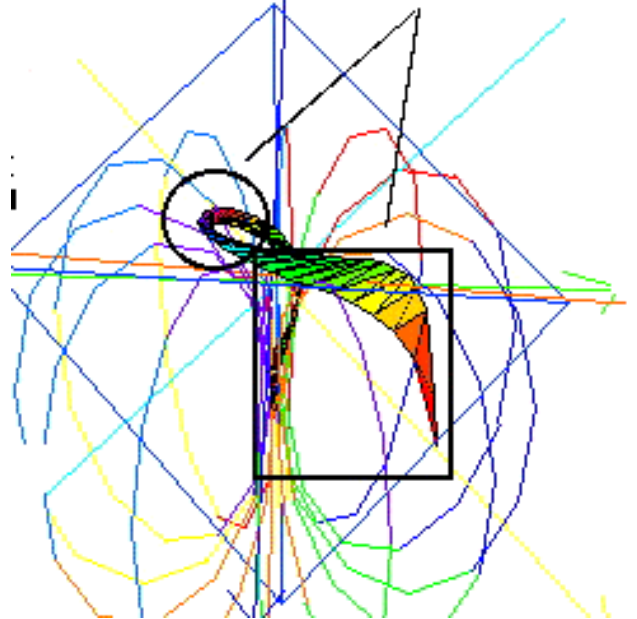
shades of the letter P or R ?



Revolving that golden mean spiral 1/10 circle, upon the donut creates a 3D "flame letter" strip



The Hebrew Letter "He", root of our letter H, as Pi, literally Squares the Circle!

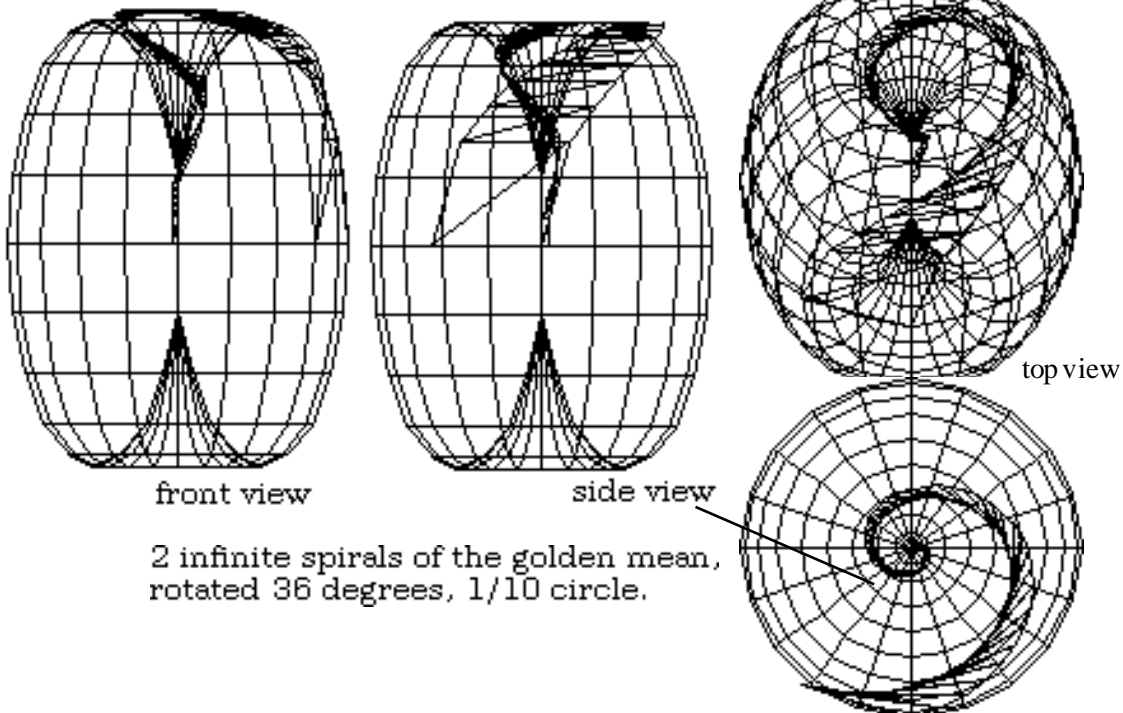


Now, having laid this spiral on the donut, we seem to have a good handle on how this donut tilts!

Notice how this donut is like "Adam's" apple..

4 Simultaneous Views or faces or phases of Adams primal apple or donut torus domain. This sample or bite, cast shadows from 3D to 2D (map between dimensions) making the alphabet.

oblique viewpoint



2 infinite spirals of the golden mean, rotated 36 degrees, 1/10 circle.





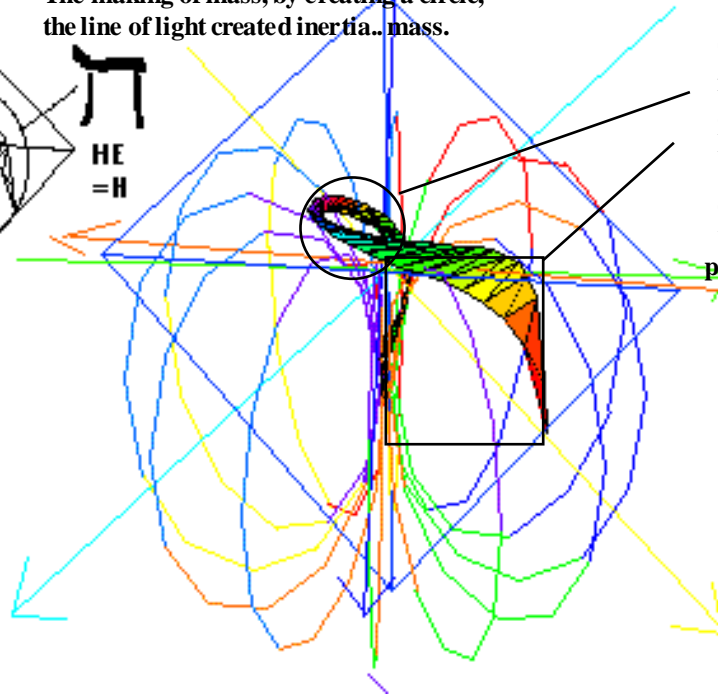
The "he" sound as in here and hence and he connote in a profound sense, literally the turning... or the presence which turn or spin creates. So the Hebrew letter HE as in YOD HE VAU HE, means amorphous and space filling..(breathes most base and unformed pressure wave).. maleness.

The making of mass, by creating a circle, the line of light created inertia.. mass.

HE  
216,-42,223



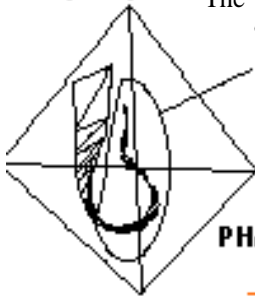
HE  
=H



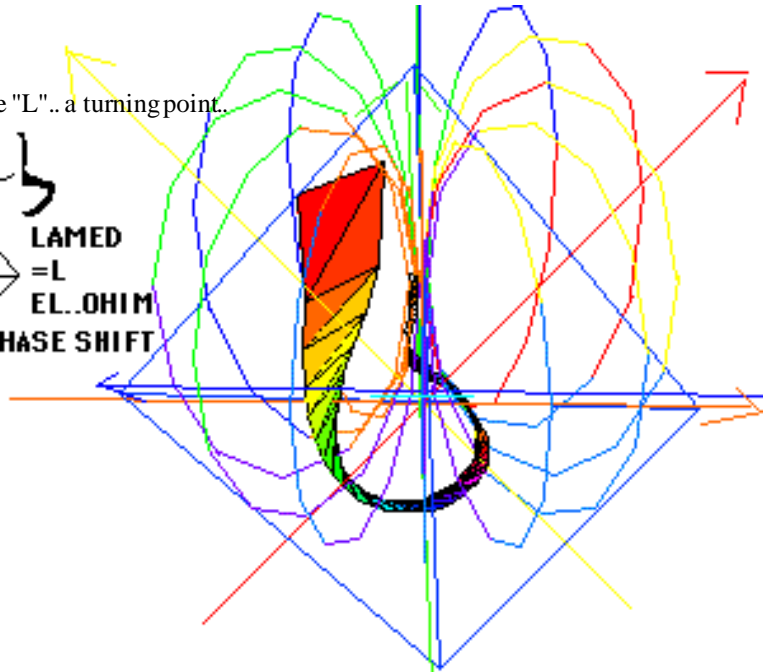
This symbol for both "H" and "Pi", literally "squares the circle, making turning or spin possible"

LAMED  
36,-45,225

The "L".. a turning point.



LAMED  
=L  
EL..OHIM  
PHASE SHIFT

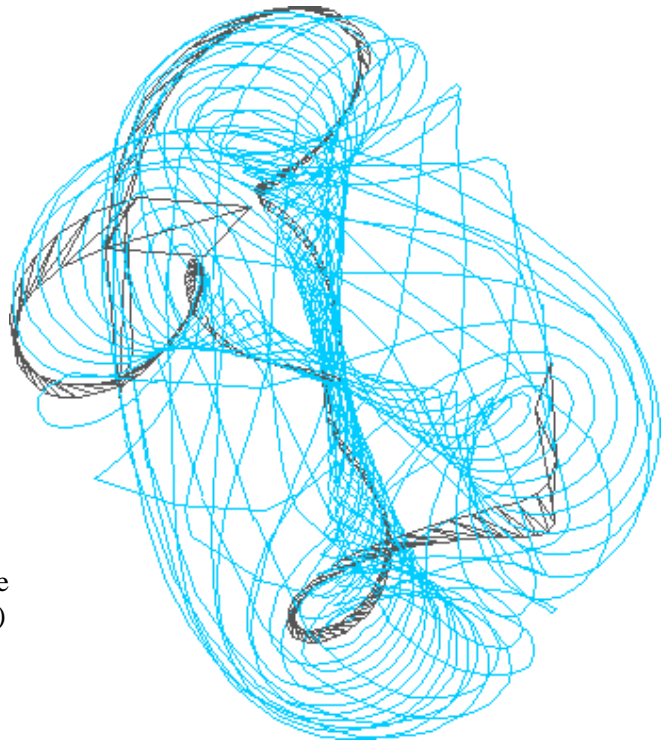


If our kindergardners begin learning the alphabet from the geometry set that MADE the letters in the first place...

1. they will never need to memorize their letters by rote. Instead learning *ONE PRINCIPLE* will be enough to recreate any forgotten member of the symmetry set alphabet.
2. when they reach chemistry study years later, the symmetry groups (subshells) s,p,d,f which make the atomic table completely, **will already be known to them by the same rule which taught them to read !**

3. the process of thinking through the symmetry laws which enable letters to fit together to make words, will eventually be refined to exactly iterate the symmetry laws which allow donut shaped fields (which are the elements of every form- subatomic to intergalactic) to CREATE anything.

This image called "Ray's Trace" is from The Alphabet Game. The child learns the bubble symmetry associated with his name. In the laws written in the alphabet of the symmetry of donuts (Adam's Apple), the universe DOES consist of everything that can be named! Word making power is the ability to nest symmetry.



The idea which needs to reach schools is simple. The process of creation: managing chaos, is no more arbitrary or less self organizing than the origin of symbol making itself. The role of symbol in making possible consciousness occurred when some condition outside a "membrane" could be *represented* inside. The set of field nestedness which comprise any substance outside the membrane (the self), are completely described (quantized) by the set of symmetry operations which allows that *something outside of me*, to stand as wave. Thus what group theory and quantum mechanics have proven is that (re)creation resolves to the elements of symmetry.

To bridge the separateness from self to not/self required holding in memory (in symmetry) the turns of mind (focus) which held together the field called a "part-I-call".

To put it in simpler terms (turns), the living cell learns that the ultimate elements which cook up the stuff happening outside the membrane resolves to the recording of a few simple symmetry operations which create everything... (most especially the membrane itself... folds are symmetry/memory/membrane "Structural Stability and Morphogenesis" cell membranes are the allowable phase symmetry, nested standing waves.)

Now, supposing you are not a philosopher on the question of the totally quintessential meaning of symmetry in physics. You are simply interested in the question: "how does language and learning happen?"

(Un?)Fortunately your dilemma must still end up in the same slip-(k)not as the fundamental fizzesist: "whatever done this, was SELF-ORGANIZING?!?! " " "

Learning for a preschooler will be exactly as wonderful as creating matter out of light, when we realize the point at which either process becomes self-organizing.

Karl Pribram "Language of the Brain" says the visual brain is a hologram of waves ..synapsing, sparks darting about. Matter (what thoughts "grasp") is also a hologram, only denser... more tightly phase locked. What is the point at which the hologram (vision or mass) becomes self-organizing? What is the point at which thoughts swap momentum (info) from objects? What is the point at which one light hologram (ideas in the brain), interacts energetically with another denser hologram (matter)?

The answer to *all* these laser like questions is the same:

**WHEN 'PHASE DISCIPLINE'- (donut tilt symmetry) IS LEARNED!** (prepare the field)

The origin of learning and language and matter, DO get us to the same question: at what point..

Our recording devices for symbol-making are a bit flat or 2 dimensional. Basically we use flat pieces of paper on which to record what is happening up there in 3D. It like reaching from flatland, 2 worlds of spin, up into the next dimension. In order to leap across the dimensions of spin, we had to sample or take a part (part I call it), of the whole donut.

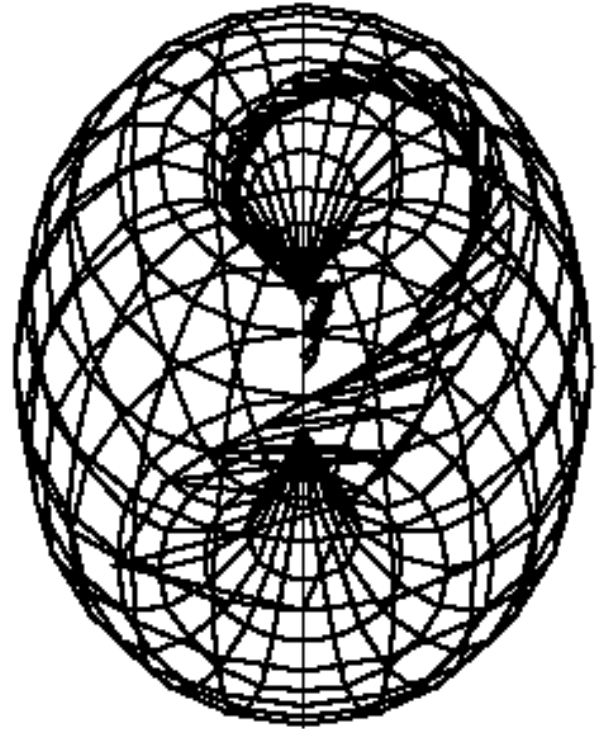


BUT, whatever part or sample we had to take off the whole (donut), had to be self-organizing. Happily again, the oldest in best problem solved in the “field” of topology had already got the word out. The donut can only be divided, separated into totally symmetrical regions, each of which touches ALL other regions, in ONE way. This self organizing division of the donut into the seven color map (the rainbow connection), produces a self organizing line or mobius strip around the donut: the golden mean spiral!

And since the spin of this golden mean spiral flame letter wrapped around the donut, records the shape of the whole thing, it is the perfect self-organizing recording device or “sample”. The elements of symmetry then are written as shadows on the wall of the cave of the membrane of our attention. They are burnt in, like perfectly tilted or phased touch can roll into the folds making the surface of a bubble without causing it to pop.

(Later, children will learn this is the way the “Sentic” pressure wave shape of touch we call Emotion, is stored on the surface of cell membranes creating the library of immune identity.

“Music, Mind and Brain” and “Sentic” by Manfred Clynes PhD., also featured on recent NOVA series “What is Music”?)



Thus I have just turned to various perspectives to be consumed in time, the self-organizing essence of symmetry. And abracadabracally adiabatically we have the ALPHABET! Our “fields” ..(math, language, religion) become self-organizing?

### “A Field’s symmetry element: byte of Adams Apple”

Well, we know the apple donut shape itself IS self organizing. This is proven among smokers, or in any cloud chamber. Only the double vortex smoke ring donut can remember its internal flow dynamics well enough to self-organize and stand as wave. (hydrodynamic physics agrees: donuts/knot theory is *in*.)

But the other thing which the origin of language (recorded memory across membrane) and the origin of matter require, is that the nesting or grouping or these donuts ALSO be self organizing.

Happily, we know that if you nest donut shaped fields into anything **but** mutually constructive symmetry (the platonic solids), they will destroy each other. (This is called quantum mechanics and group theory). SO, once donuts are born, if you push them into a confined space, they *self-organize* into the symmetry (nestedness), we have called matter. (Focus self replicates order, & self-destructs disorder.)

So, we really got the principle. It’s so easy it almost “goes without saying.”(Maybe it did for a while). Donut field symmetry IS the mechanics of creation.

So this is the origin of making SYMBOLS - alphabets. And it is the proper way to learn to read. By learning the angle at which to enter a donut (vortex) to best enter COMPRESSION - you ARE symbolizing - because symbolizing IS the process of making a picture inside which is a perfectly COMPRESSED picture of what is outside! The way to do that is to invite charge to compress - which is the way pattern is stored in MATTER creation AND therefore symbol creation.

**Implosion  
 (Your Heart in BLISS)  
 Works only in the  
 SYMMETRY of NON-  
 DESTRUCTIVE COM-  
 PRESSION.**



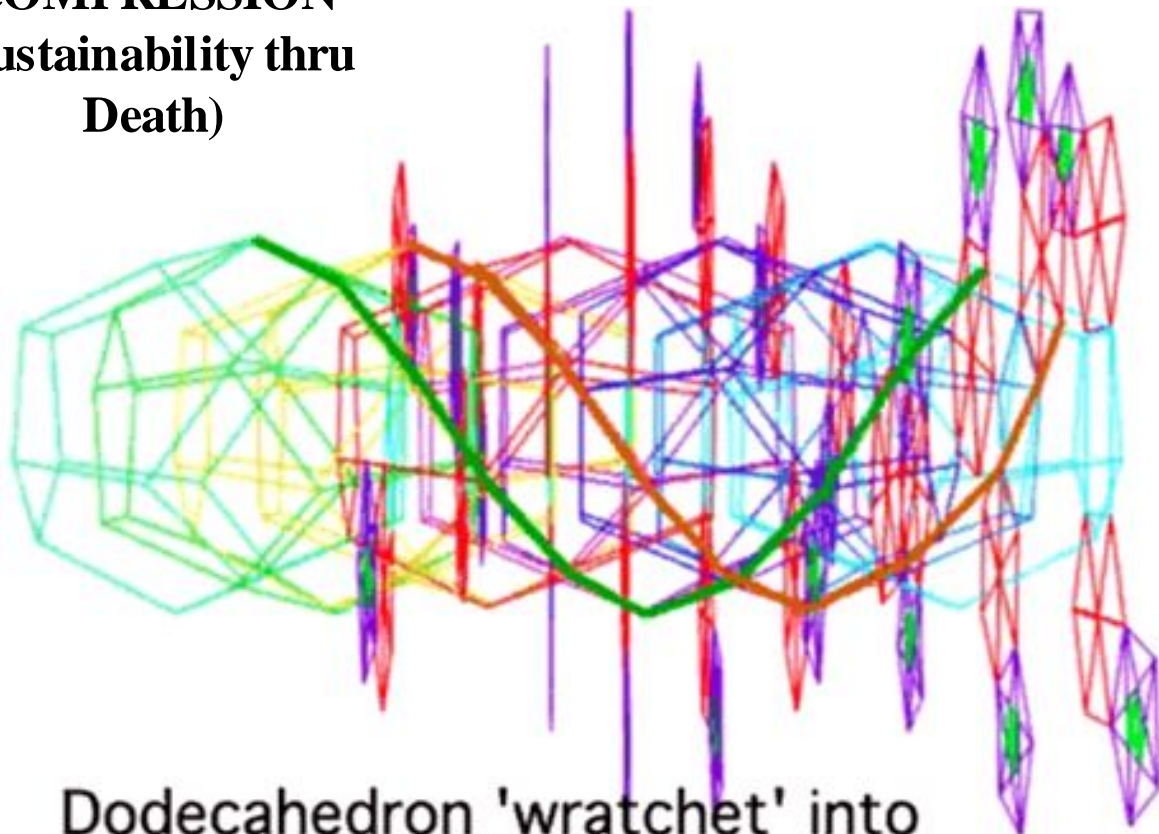
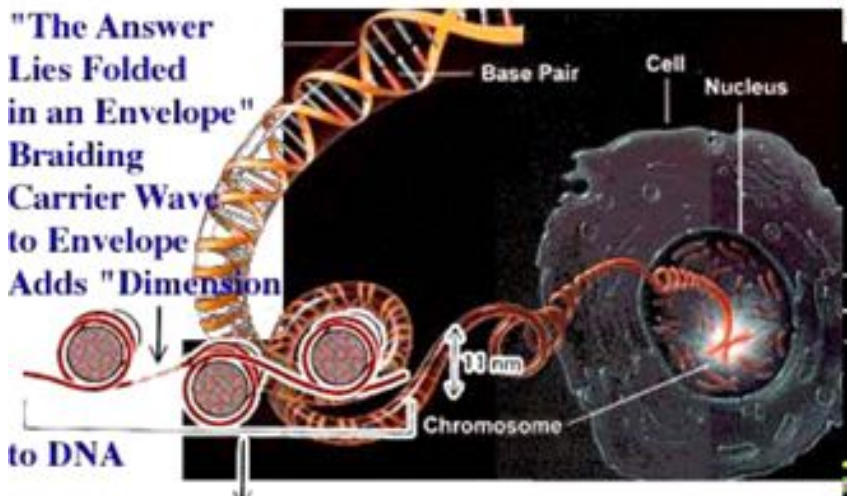
The "Magnetic X" where your DNA  
 "crosses itself" can become RADIANT  
 When recursive or embedding..

**Your DNA in your blood,  
 for Example uses  
 Golden Ratio 'Recur-  
 sion' to turn COM-  
 PRESSION in to AC-  
 CELERATION..**

**a real rush for you!**

**To achieve IMPLOSIVE  
 COMPRESSION  
 (Sustainability thru  
 Death)**

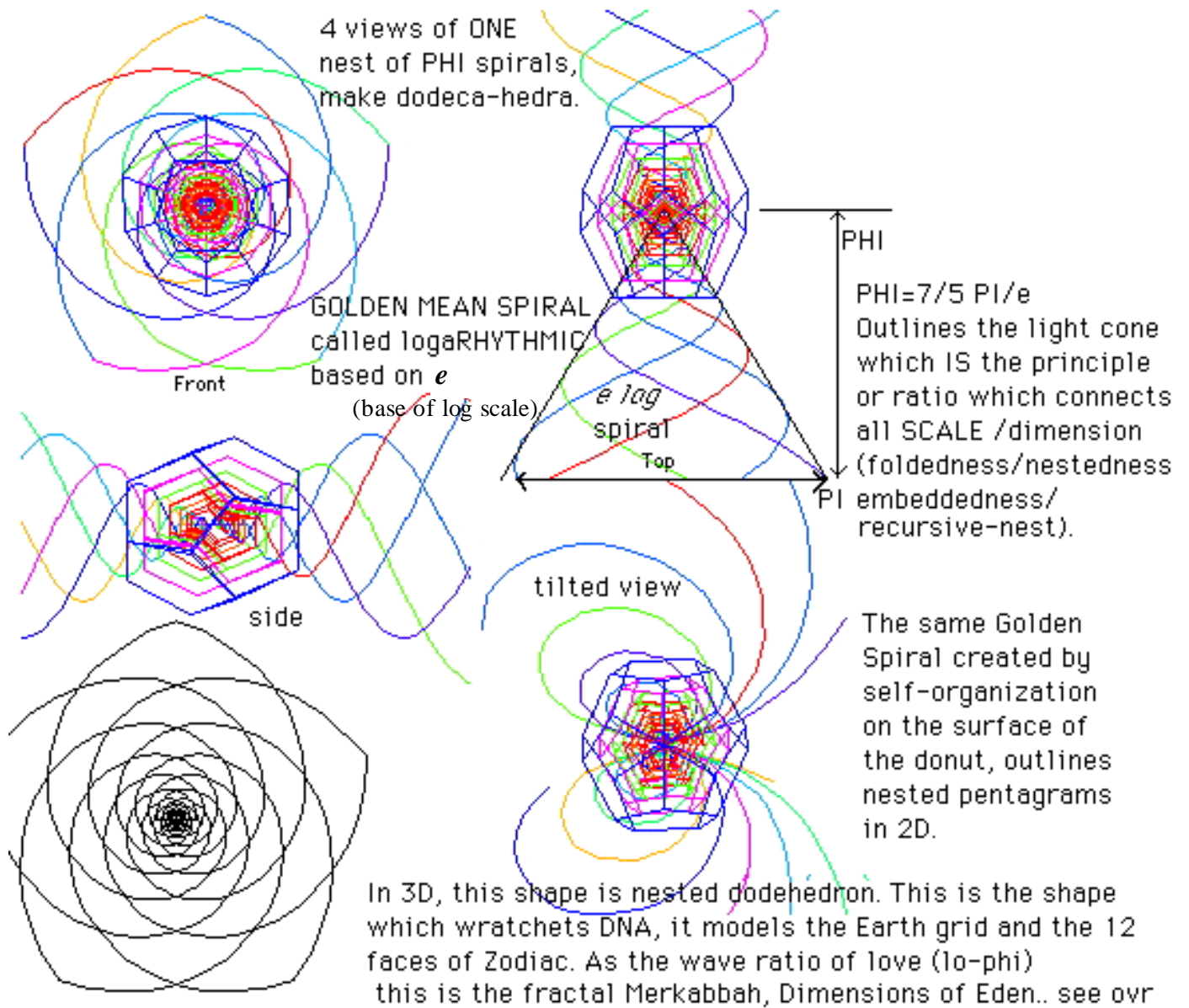
"The Answer  
 Lies Folded  
 in an Envelope"  
 Braiding  
 Carrier Wave  
 to Envelope  
 Adds "Dimension  
 to DNA"



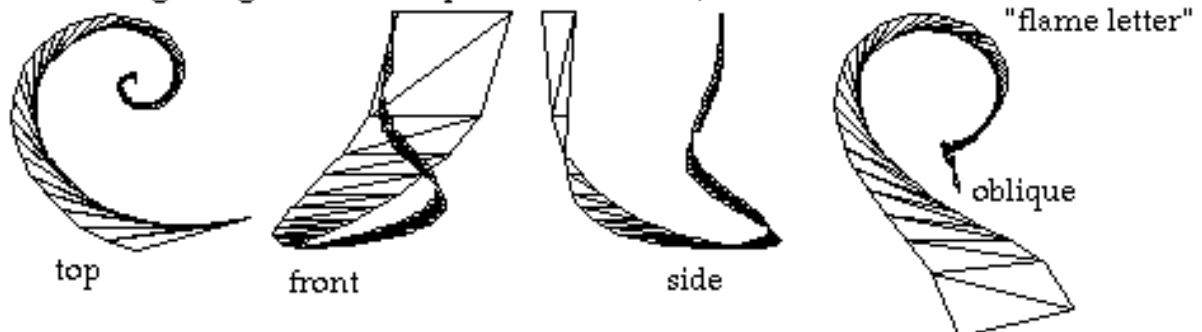
**Dodecahedron 'wrench' into  
 the DNA double helix, side view...**



*You don't need to worry about the math on these pages ('equations') - if there are not familiar - but notice how the pictures have a magical and dream helping - quality.*



Revolving that golden mean spiral 1/10 circle, upon the donut creates a 3D



# Vesica Pisces... We-Seek-A-Pi-Sees

Spiraling Squares, Golden Rectangle

The Eye of God

4 Spirals of the Golden Mean

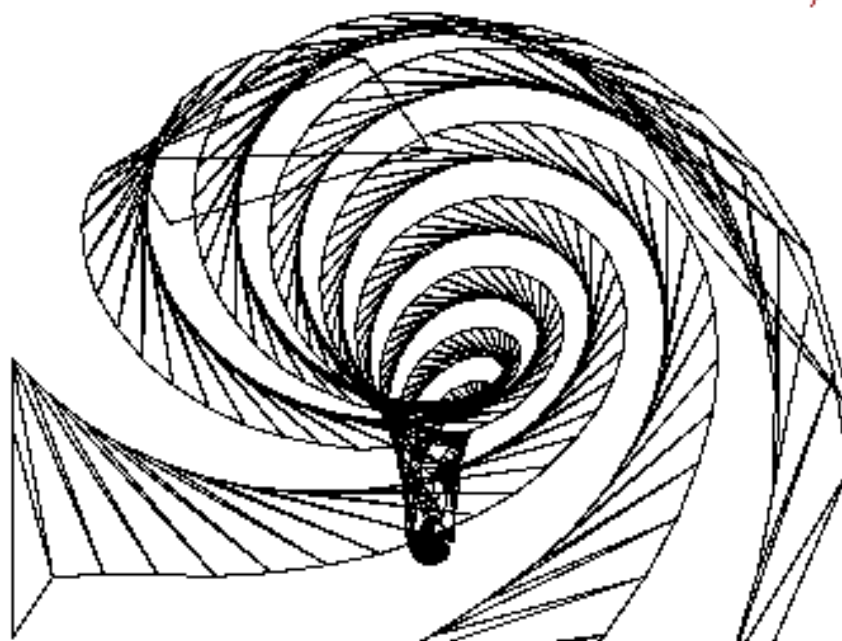
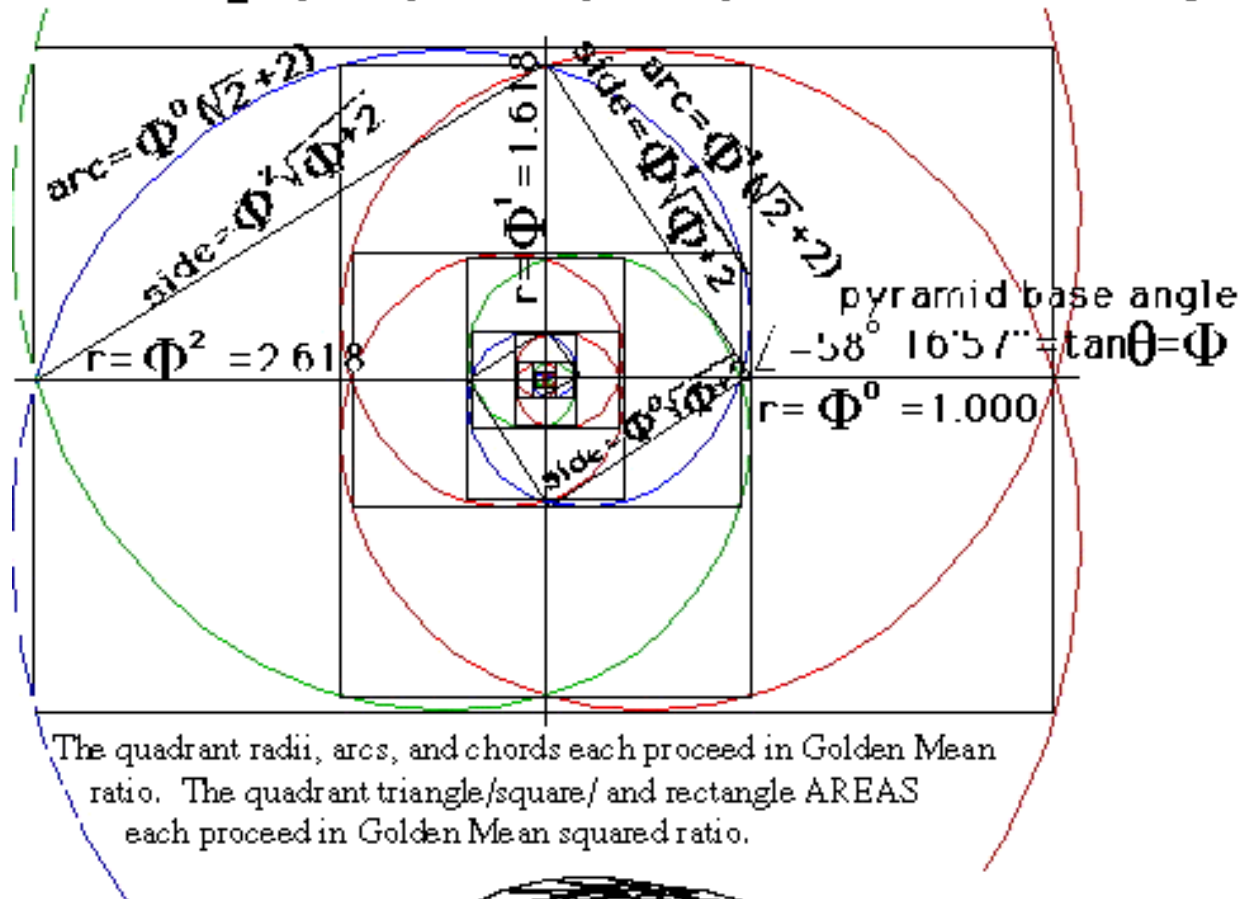
Golden Mean: 1.618033989...

$$r = \Phi^{(2\theta/\pi)}$$

$$\Phi = (7/5)(\pi/\epsilon)$$

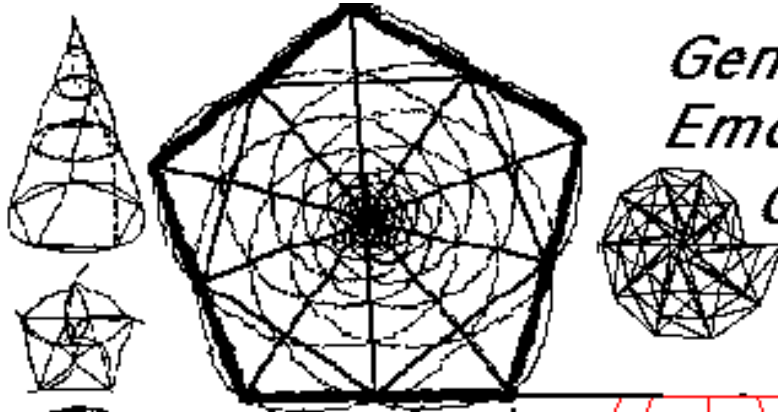
$\epsilon$  = base of natural log = 2.71828.

written as  $\Phi$  spelled "phi", as in "phi-lo-so-phi" : love of wisdom or knowing.





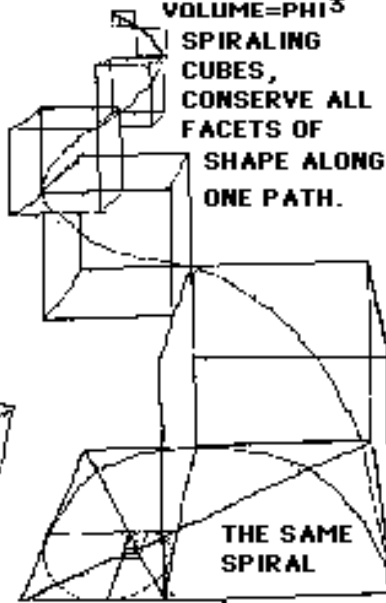
# Genetic Biology: Emotion's Golden Braid



LENGTH=PHI, AREA=PHI<sup>2</sup>

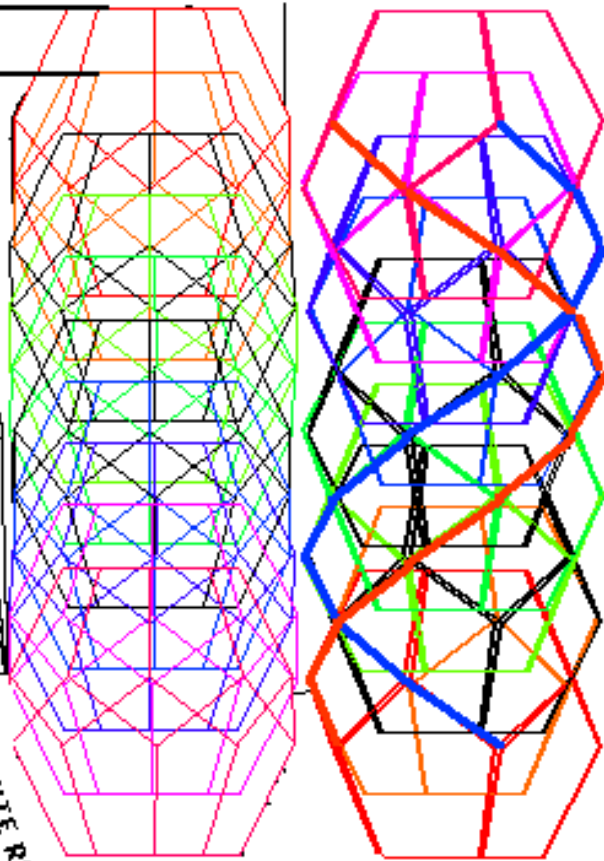
VOLUME=PHI<sup>3</sup>

SPIRALING  
CUBES,  
CONSERVE ALL  
FACETS OF  
SHAPE ALONG  
ONE PATH.



SOURCE OF  
VESICA/  
"EYE OF GOD"

INFINITE RECURSION  
SELF EMBEDDEDNESS

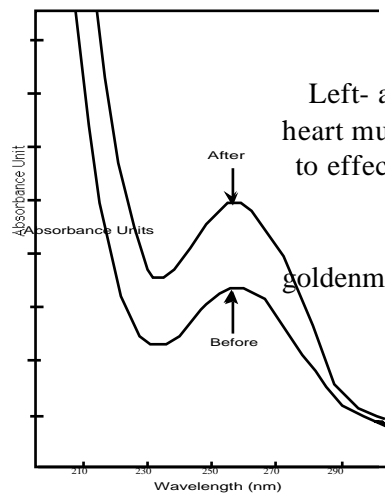
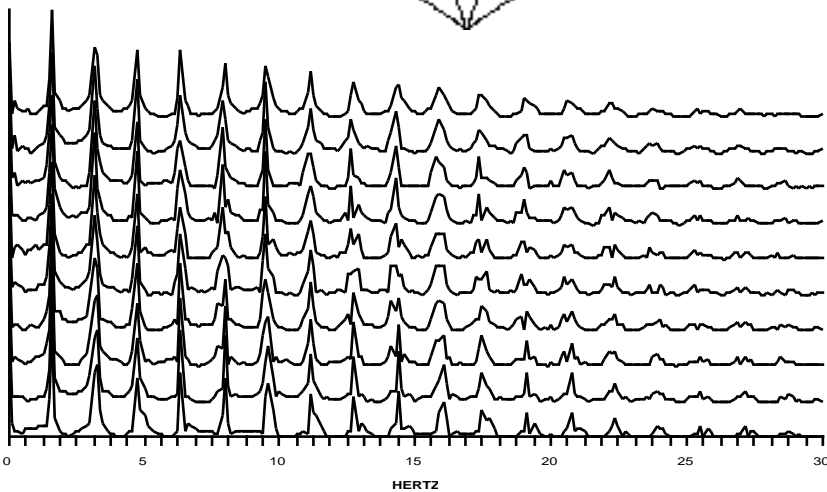
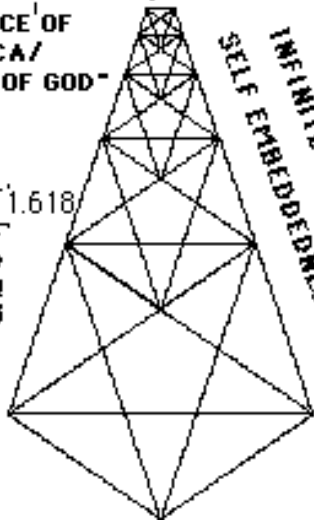
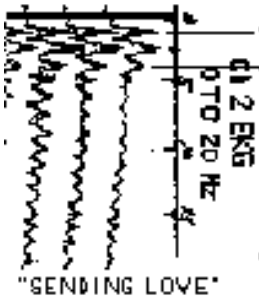


DOUBLE HELIX, DNA TRACE  
SHADOW OF WRATCHETING  
DODECAHEDRA.

CUBE IS 3<sup>RD</sup> SPIN SPACE  
DODECA IS 4<sup>TH</sup> SPIN OF CUBE,

DNA DODEC WRATCHET  
IS 5<sup>TH</sup> SPIN (DIMENSION)  
BRAID OF DNA IS 6<sup>TH</sup>  
BRAID OF BRAID=7<sup>TH</sup>  
(LONG WAVE OF EMOTION).

HEART SPECTRA



Left- a picture of how  
heart music was measured  
to effect the BRAID - in  
DNA..  
Study at  
[goldenmean.info/rein](http://goldenmean.info/rein)

Braiding  
**DNA**

is  
EMOTION  
the  
WEAVER?



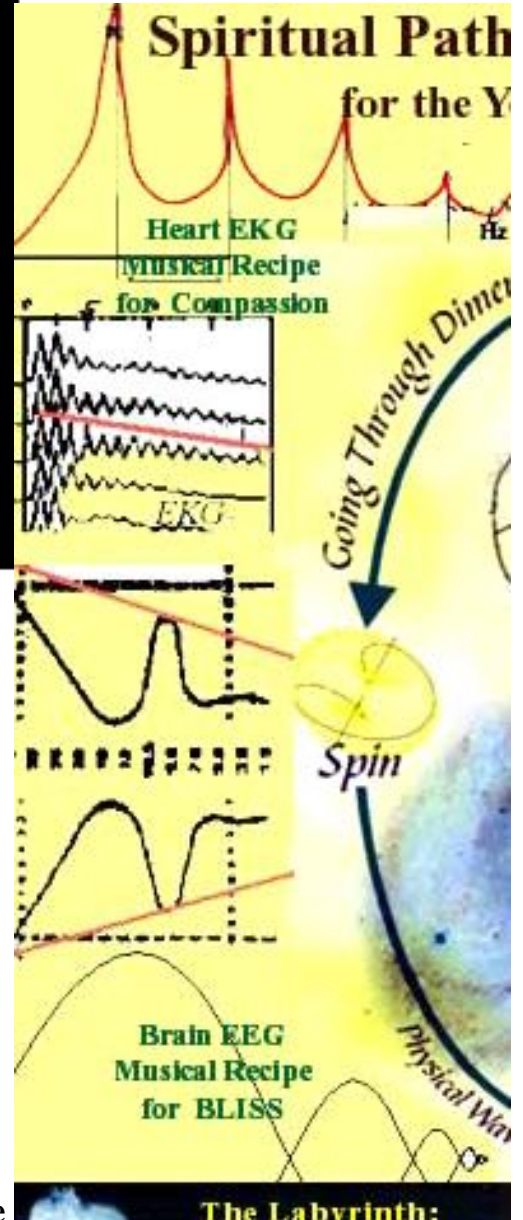
Heart's during BLISS - ECSTASY - ENLIGHTENMENT - make MUSIC! The musical notes present - in the LOVING heart - make a SNAKE CHARMER. The sound of the heart makes notes in a CASCADE - this means- like a waterfall. (This is what the HeartTuner tunes : [heartcoherence.com](http://heartcoherence.com) ).

The effect of this cascade of the BLISSFUL sound of a loving heart on DNA in your BLOOD- is KEY to how BLISS makes you immortal!

It starts when we measure the effect of the SOUND the heart on DNA. It BRAIDS- It Wraps - It Plaits- It makes the slinky turn. DNA in your blood responds like a SNAKE CHARMED to the COHERENT sound of the heart in LOVE!!

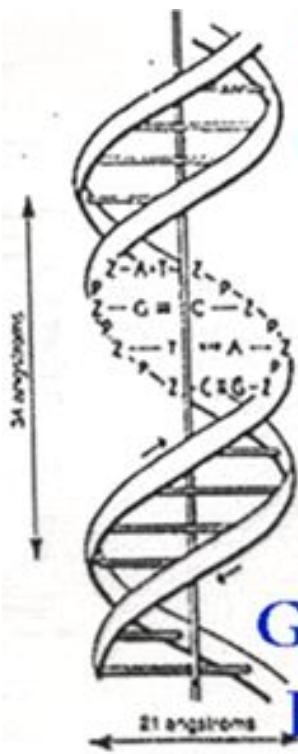
This is a clue to how your THYMUS around your heart- is used as a catchers mit for the sound of LOVE and BLISS to make the WHITE BLOOD CELLS - which are your IMMUNE system - your health!

It is important to realize that BLISS and Heart's that sing - effect our genes- our blood- our DNA. Because this allows science to teach BLISS - and it's necessary role in making healthy and sustainable blood.  
EMOTION ACTUALLY PROGRAMS DNA..

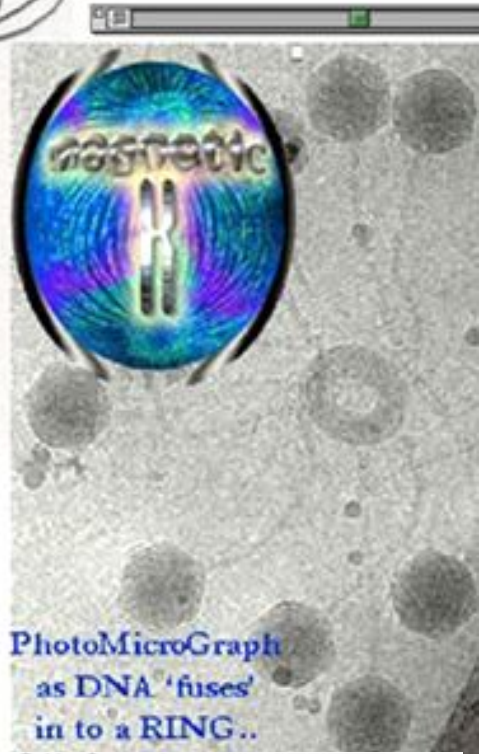
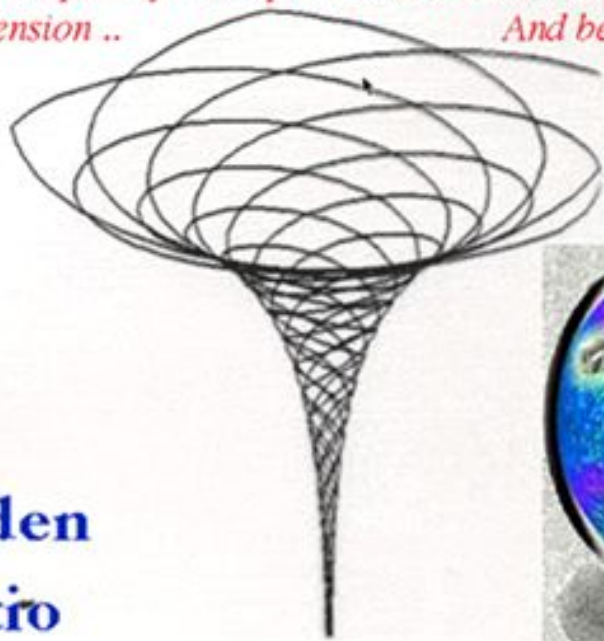




*When Proteins learn to Swallow Lightning (in 'Primal Soup')  
They shape shift / morph / worm into the next (spin symmetry)  
Dimension .. And become DNA..*



**Golden Ratio**



*When they learn to spit out lightning..  
(bliss - coherence).. You Survive Death.*

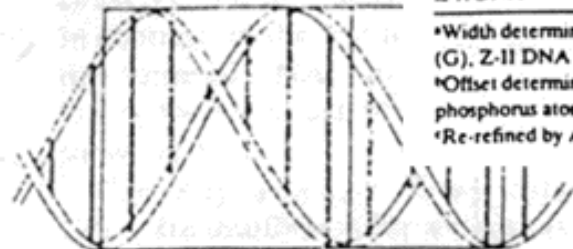
*Right: PhotoMicrograph- Under Charge Compression (Bliss)-  
DNA Fuses into Ring Donut- Lord of the Ring..  
(soulinvitation.com/ringlord )*

**PhotoMicroGraph  
as DNA 'fuses'  
in to a RING..**

*Table 1. Models of DNA Structures and their fit to the Golden Ratio.*

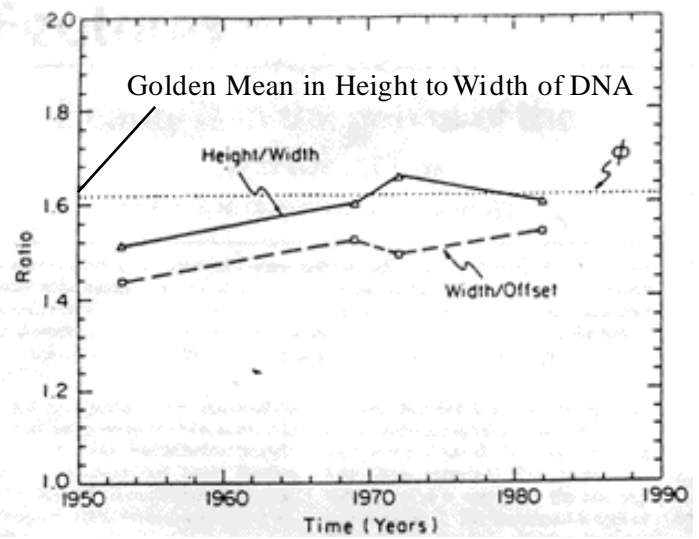
Model	Height (Å) (pitch)	Width (Å)* (diameter)	Offset (Å)*	Height/width	Width/offset
A-DNA <sup>5'</sup> , C	25.6	18.9	19.1	1.05	0.99
B-DNA <sup>3'</sup> , C	33.8	21.1	13.7	1.60	1.54
Z-I DNA*	44.6	17.5	15.9	2.55	1.10
Z-II DNA*	44.6	18.3	10.9	2.44	1.68

\*Width determined by the atom most distant from the helix axis. A-DNA O5', B-DNA O2P, Z-I DNA C8 (G), Z-II DNA O2P (C).  
\*Offset determined by vertical separation between the two helices of the double helix based on the locus of phosphorus atoms.  
\*Re-refined by Arnott, S. and Chandrasekaran, R., personal communication (1982).

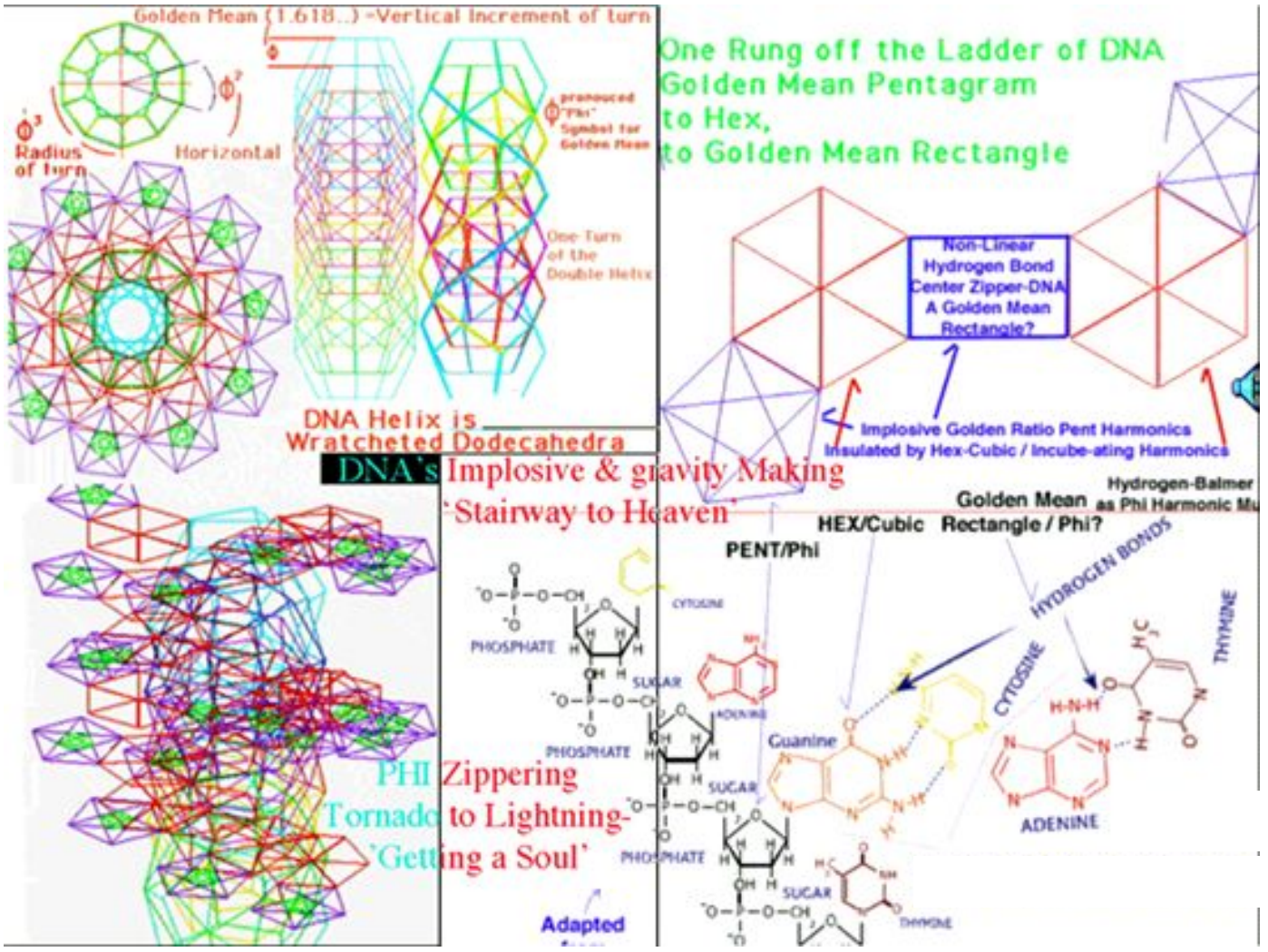


*Fig. 1. Golden Ratio in DNA.*

**GOLDEN MEAN  
in DNA  
and Parthenon**







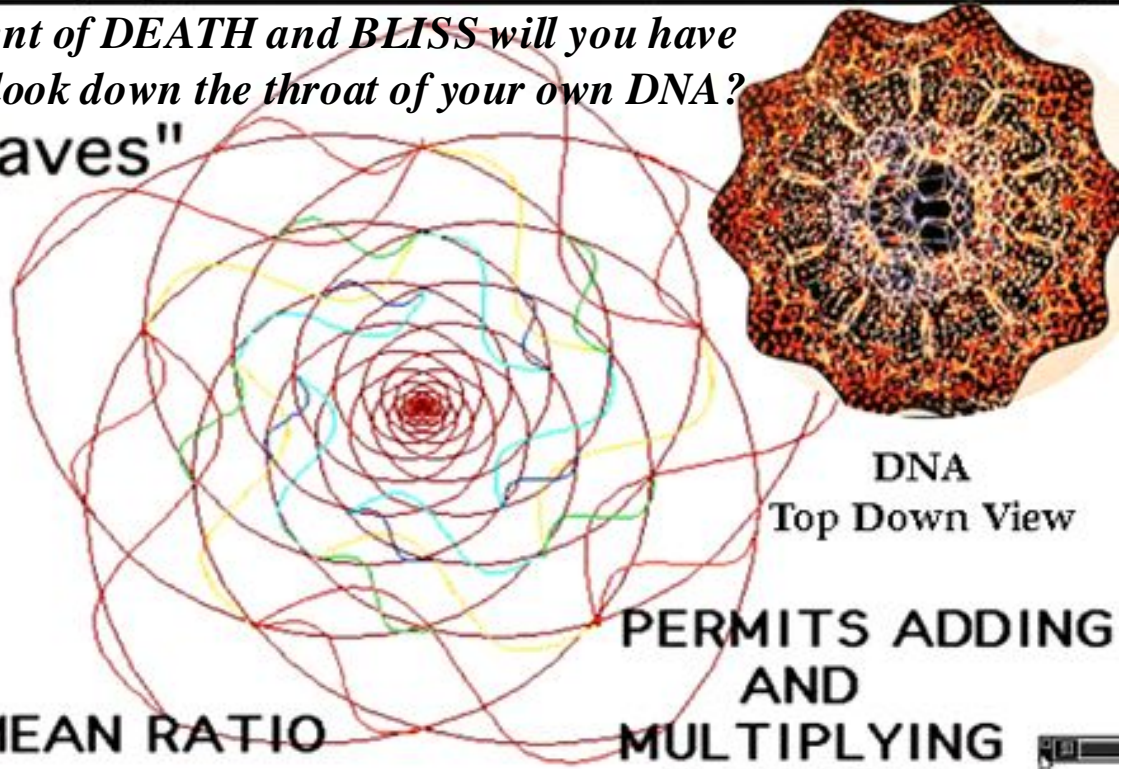
‘Contact’ing Compression

Perfect Heterodyning (Constructive Wave Interference) Produces Implosion / Sorting..

*So: at the moment of DEATH and BLISS will you have the courage to look down the throat of your own DNA?*

"Sine Waves"

‘Self Similar’ geometry (Golden Mean) turns compression into acceleration..



DNA Top Down View

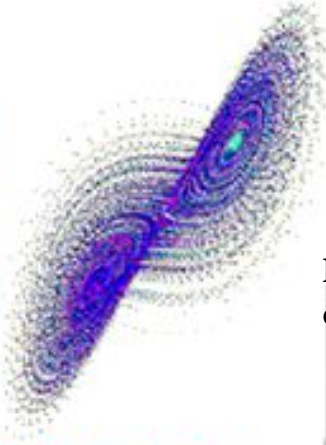
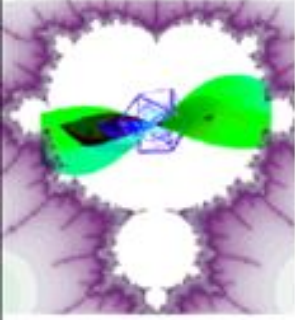
GOLDEN MEAN RATIO

PERMITS ADDING AND MULTIPLYING OF WAVES

*There to see the view of every wave that can meet so perfectly. PURE INTENTION (a shareable wave) is the leap down the RABBIT HOLE! Implode & Live thru Death.*



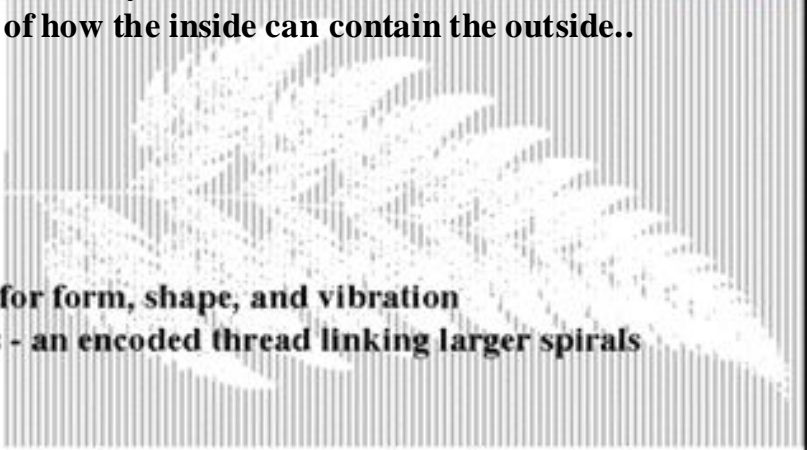
# What is Self-Similarity.. Self Embedding



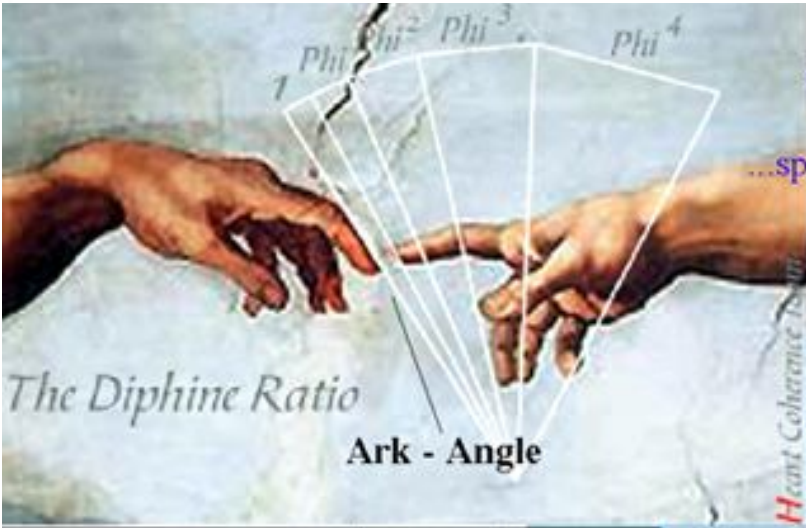
DNA in your blood - is based on the science of how the inside can contain the outside..

## What IS a Fractal Attractor? -

Fractals provide a wave 'massage' path for form, shape, and vibration into higher and higher evolving patterns - an encoded thread linking larger spirals into smaller spirals and on to infinity.



Self-similarity means the inner structure has the same pattern as the outer structure. Examples of natural shapes which tend to be fractal or 'self-similar': a pine cone, or a fern tree, or a pineal gland - have a shape that - in 3D - you could begin zooming down into center - and still ALWAYS be seeing the same thing! Think of the classic Russian Dolls - where they all are shaped so that the whole family of doll fit perfectly one inside the other. (An onion is another example of a potentially 3D fractal).



Michelangelo Buonarroti 1475-1564 (!) Sistine Chapel, Vatican, created between 1508-1512 detail "The Creation of Adam" ...sparking the harmonic Essence into the flesh..?

## Hand bones





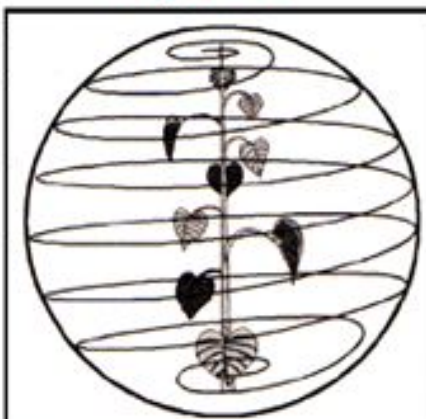
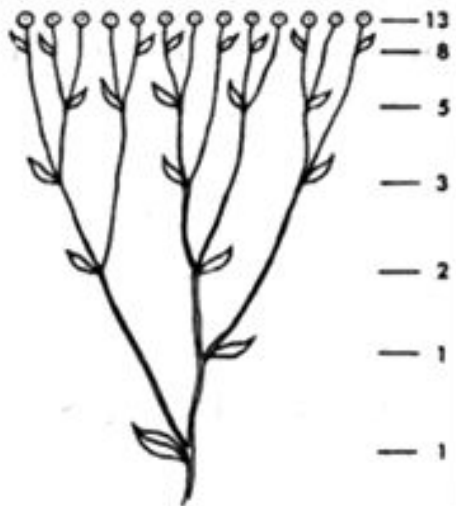
SUC-

pairs of numbers in the Fibonacci sequence. These ratios and their decimal approximations are shown below. The ratios approach the ratio of the Greek golden rectangle: 1.61803 to 1.

$\frac{1}{1} = 1.0000$	$\frac{2}{1} = 2.0000$
$\frac{2}{3} = 1.5000$	$\frac{3}{2} = 1.6667$
$\frac{3}{5} = 1.6000$	$\frac{5}{3} = 1.6250$
$\frac{5}{8} = 1.6154$	$\frac{8}{5} = 1.6190$
$\frac{8}{13} = 1.6176$	$\frac{13}{8} = 1.6182$
$\frac{13}{21} = 1.6180$	$\frac{21}{13} = 1.6181$

# Fibonacci Progresses To Golden Mean Ratio (Phi) "Phi-Bon-a Key!"

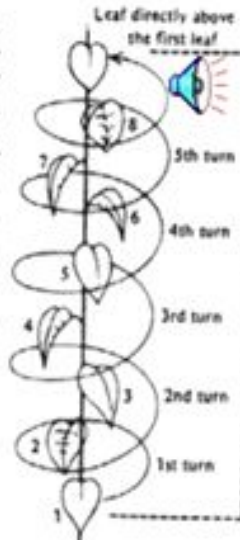
## Phylotaxis



The green plant is the visible part of a spiraling energy field.

### Extension

The number of petals on flowers will vary according to the kind of flower and not every flower of a particular species is identical. The arrangement of leaves on a plant will usually produce two Fibonacci numbers: (1) the number of leaves it takes to go (rotating about the stem) from any given leaf to the next one "similarly placed" (above it and in the same direction) on the stem; and (2) the number of revolutions as one follows the leaves in going from one leaf to another one "similarly placed."



The figure at the right shows this leaf arrangement.

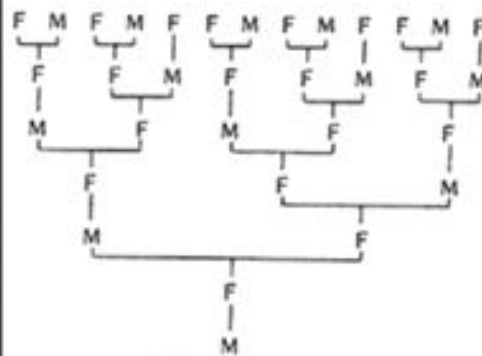
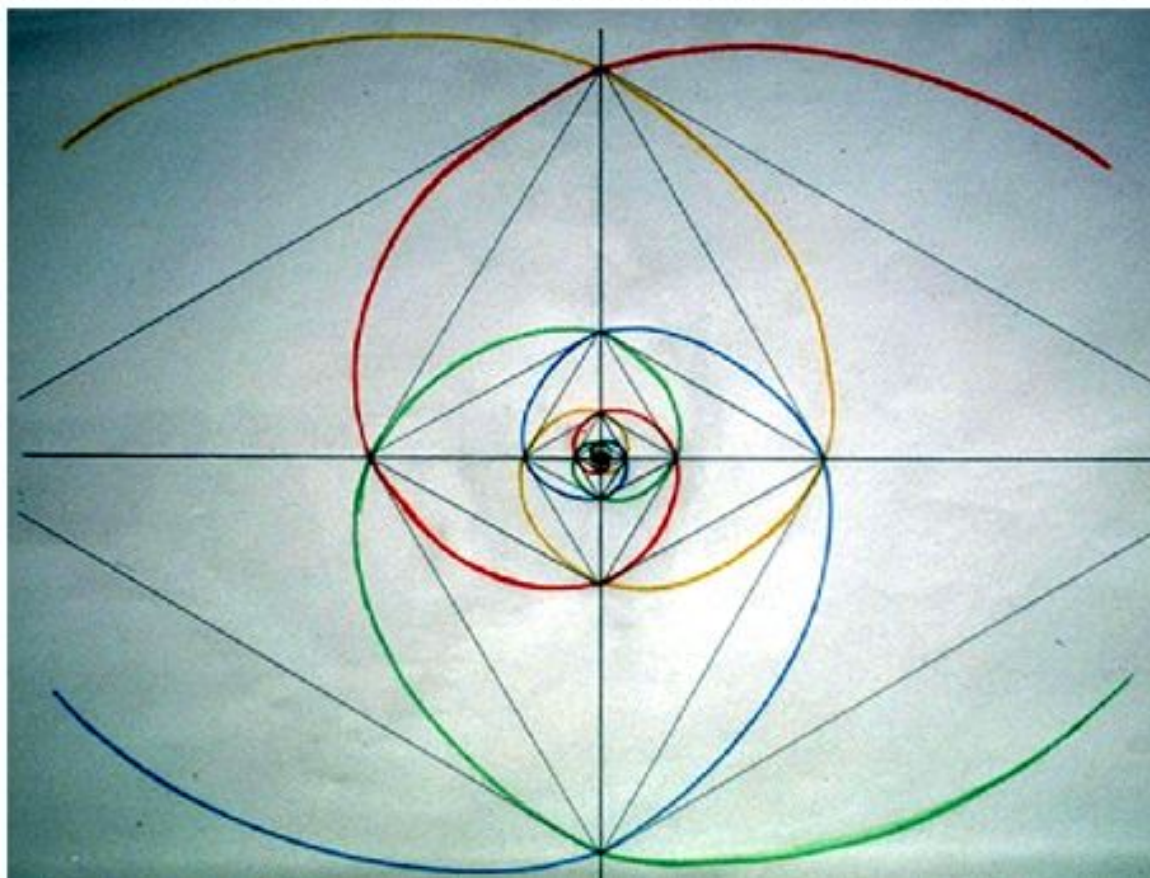


Fig. 12.5. Sneezewort (*Achillea ptarmica*)

Vesica Pisces (Eye of the Fish)/Enki.. We Seek a P' eye that Sees.. Perception Occurs Where Waves are ABLE (by symmetry) to Come to Focus...





Next- we must understand how - getting the RINGING rush of BLISS in your heart - LIGHTS THE FIRE IN YOUR BLOOD.

The little slinky helix that braids or nests information in your blood is called DNA. To get that to absorb SPIN -the rush of BLISS - your DNA was set up to swallow lightning!! In fact that is how DNA got born.

Bliss - is coherent sound in your heart. This acts as a snake charmer to program DNA by braiding it - until it catches FIRE - by becoming a DONUT and imploding. (Lord of the RING - science).

*Dr. Irving Dardik says*  
goldenmean.info/dardik  
originally: Cycles Magazine

*“(Heart music) is a wave within a wave - waving. It is SUPER-Looping”*

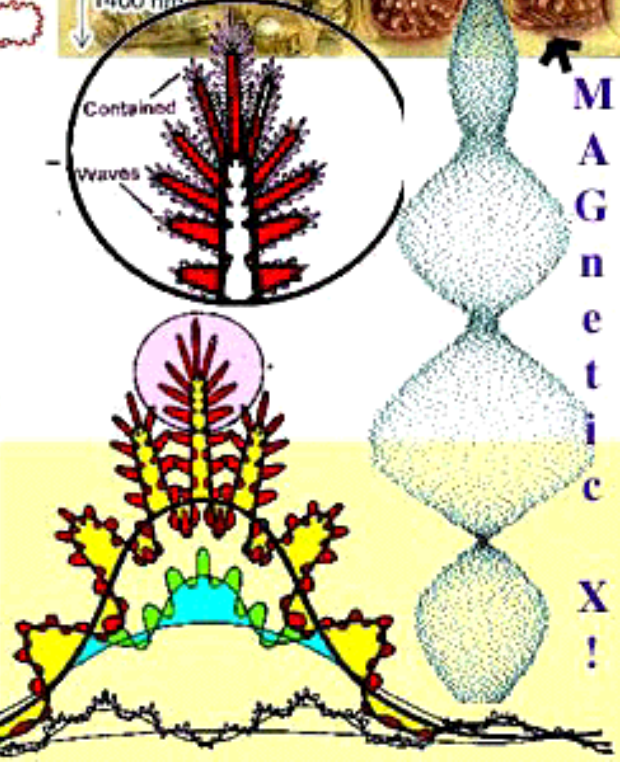
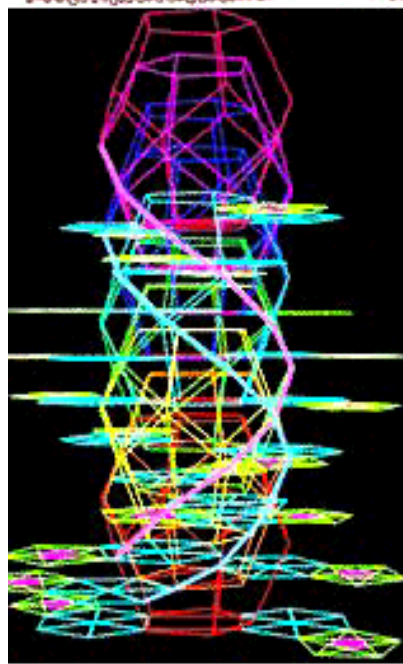
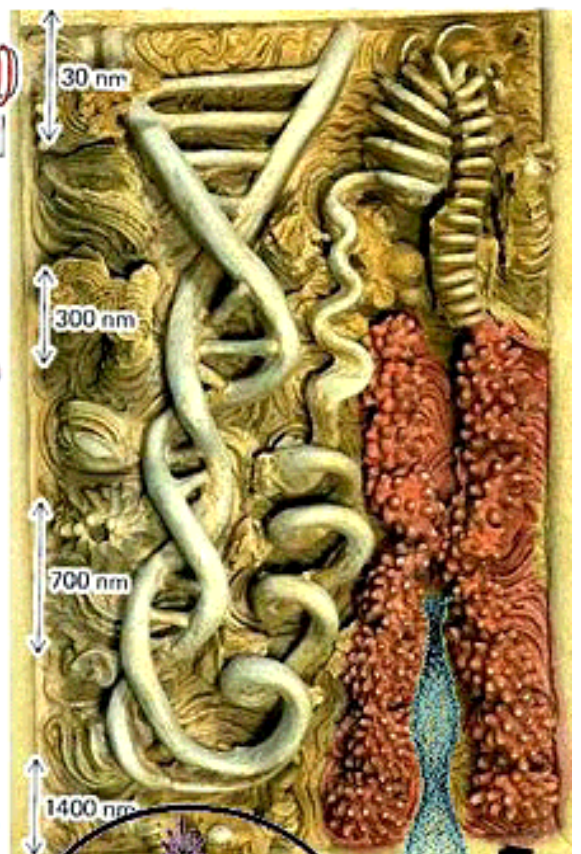
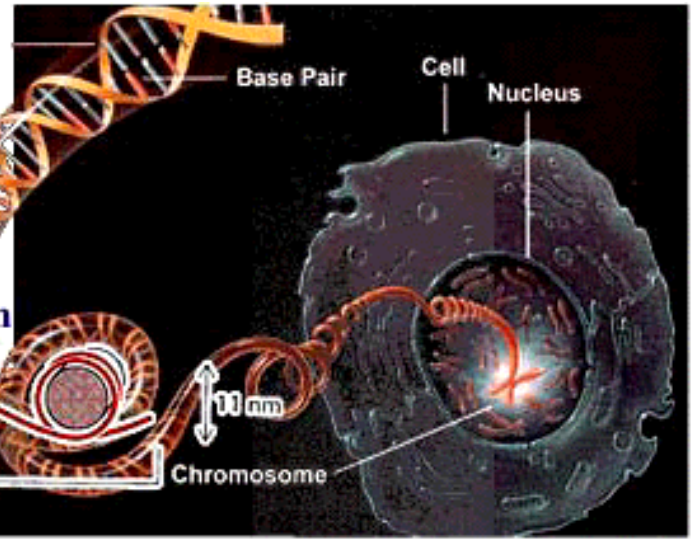
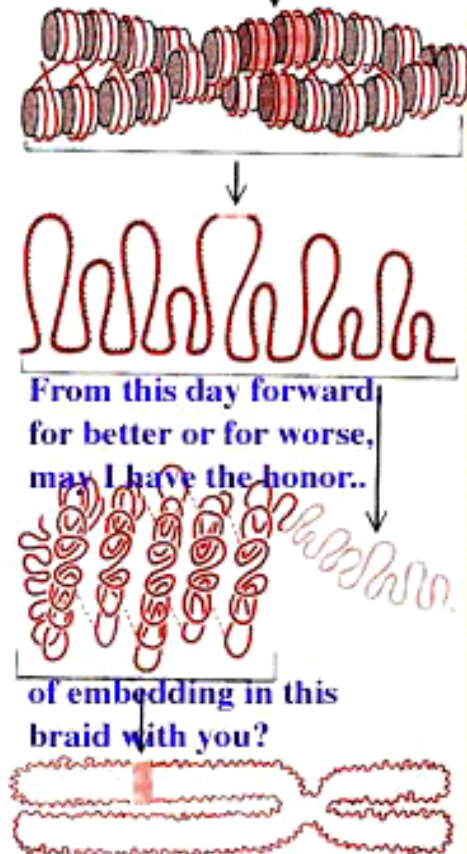
*The Heart Beat as a wave, nested within the Heart Rate as a wave, nested within your Breath as a wave, nested within your Day?? as a wave, nested within your .. planet.. star..?*

Making the connection..

Glen Rein - did the study at Heart Math Institute, after we discussed the chapter from my book “Braiding DNA: Is Emotion The Weaver?”  
goldenmean.info/rein

showing blood DNA braiding responded MEASUREABLY to HEARTS that SING - (coherence in the EKG!\_

**"The Answer Lies Folded in an Envelope"**  
**Braiding Carrier Wave to Envelope Adds "Dimension to DNA"**





*The zipper wraps - by listening to the shape snake charmer of the heart sounds.. in bliss.*

*The braid programs codons (the pieces inside DNA)*

*because only those exposed get access to RNA. Emotions - program DNA by geometry.*

*If you give up on having BLISS - then the THYMUS - the catchers mit for your heart's music- begins to shrink and die. This causes you to join the BORG. Do not give up on getting BLISS!*

**More on 'Plaiting' Your Lover's Pony Tail -- or - The Braiding Gene Story...**

Now let's try to visualize what braiding does to the wave envelope structure within DNA..  
Imagine that the Purple and Blue Double Helix above are the musical wave sample shown below..  
just a sine wave beginning to be compressed or embedded..

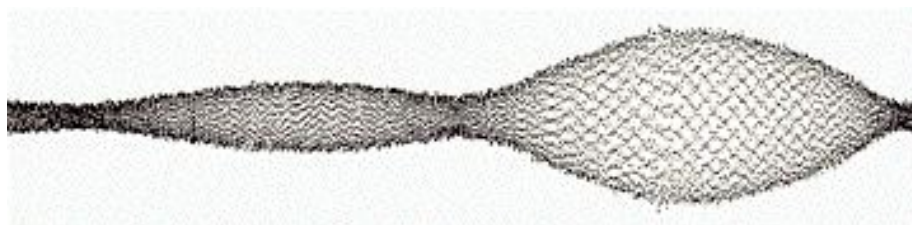
*How does BRAIDING WORK? You take two handful strands of your lovers long hair. Then you make an over, then under motion until you have plaited or braided her pony tail. Now, since your hands get closer and closer to each other as you braid, thus - when you are done - if you were to take the hair from one hand and instead draw the path in space you had followed with a pen, you would have drawn: the CADDEUCEUS SHAPE WHICH IS THE SPECTRUM ANALYSIS OF HEART EKG DURING BLISS.*



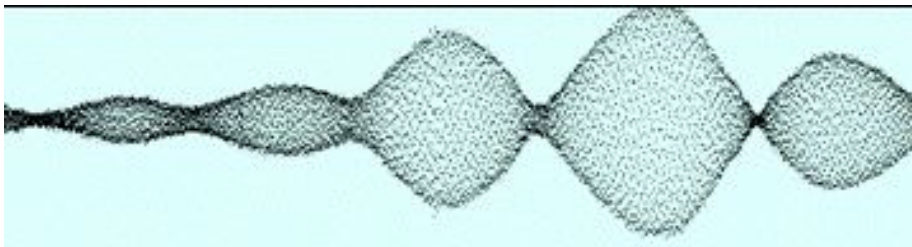
Left: the strands - of the double helix ABOUT to begin braiding (the 'carrier wave' - get's 'folded in an envelope') the geometry of BRAIDING.... NESTING... "The answer lies folded in an envelope"



As we zoom further and further out, we discover if there is discipline, or coherence in the braiding algorithm of our DNA..

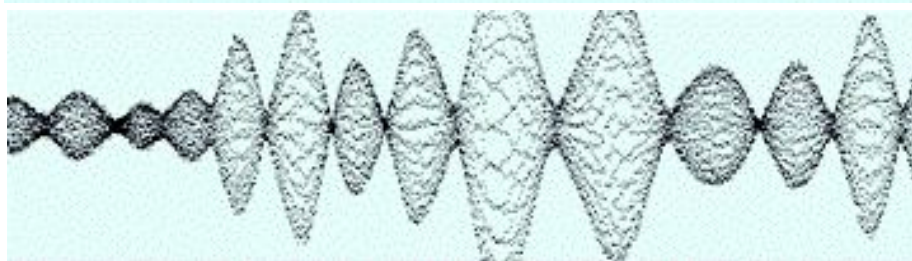


we begin to see that the only possible coherence or nesting within nesting that IS POSSIBLE, is the perfect geometry of nesting, WHICH IS THE GOLDEN MEAN RATIO IN THE BRAIDING OF DNA..



(coherence/real gene POWER , is ONLY possible in the presence of perfected nesting - embedding).

When a braid nests upon a braid - 'recursively' - eventually the thickening DNA rope would.. turn inside out?



next up..... BUT WAIT - WHAT WOULD HAPPEN IF THE GENE WANTED TO FINISH THIS BRAIDING INTO RECURSION / TURNING IN-

SIDE OUT.. What would TURN OUT??

***Introduction to - Circular DNA - Ring DNA & Lord of the Ring...***



*When your DNA Rings.. Answer the phone..*



We make an ALPHABET of the angles of charge compression necessary to weld that elusive slinky DNA finally into a DONUT--- a RING!!!

That way, it could finish the process of compressing charge (all biological memory) into the 'self-similar rose' fractal flower of recursion. This would non-destructively (by PHI 'heterodyning' - constructive ADDING of wave VELOCITIES) - ACCELERATE your biological memory THRU THE SPEED OF LIGHT .. (& make gravity in the process - why you lose 10 oz. or so at the instant of death?)

Your DNA is very aware that it is fatal (mortal) to be caught below the speed of light. In order to

avoid this embarrassing end to sustainability - your genes (being considerably smarter than you) are constantly trying to get up to speed (sustainable). They do this at moments when they have peak harmonic inclusive charge density available. Their raw material for getting thru the speed of light is the coherent ultraviolet light which is the ultimate product of cell metabolism (the most information dense stuff which comes out in a measureable burst- to choreograph / arrange the dance of cell replicating for example - microtubules as wave guides - also a key to the switch from cancer to bliss.)

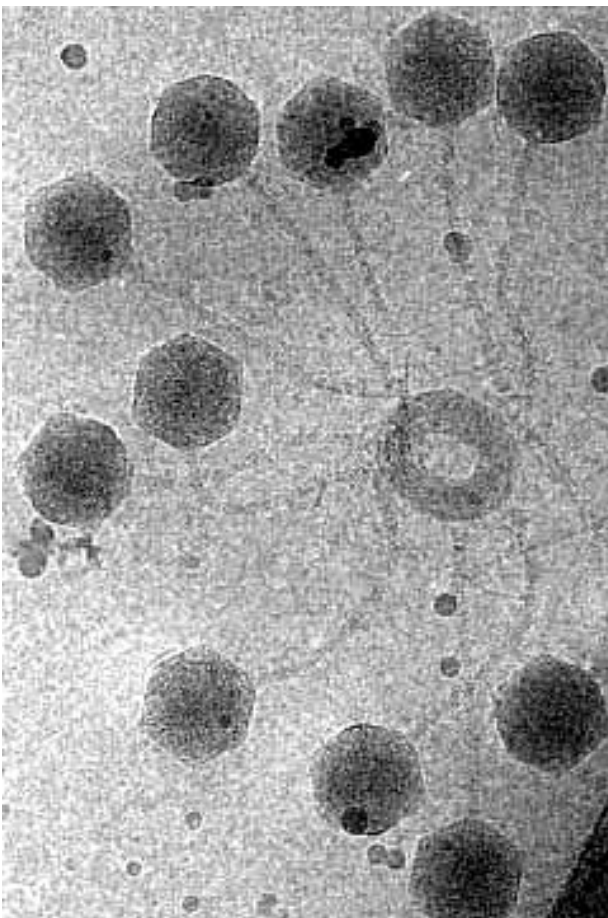
*The glossary in back is helpful here*

Make your "COCOON": "If this is the beginning of love- you could be in trouble" - When the envelope of the high quality Ultraviolet Light - reaches a high and escape velocity - that COCOON becomes navigable / steerable. This is the BLUE FIRE you see during good sex, tantra, kundalini, menopause, and BLISS. IT IS NOT A DISEASE.. it is rather your only hope to survive.

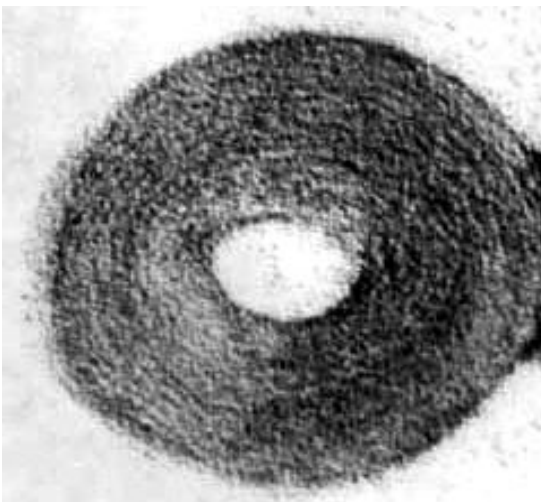
Meanwhile - if you are emoting blissfully - your glands are making COHERENT low frequencies of sound energy (called phonon in the body - as a sound wave thru liquid). These are the waves which HeartTuner (heartcoherence.com) takes the frequency signature of to MEASURE - COHERENCE, PASSION - and the moment of phase lock - EMPATHY to the one you heal or love.

When those low frequency sound waves become ordered or COHERENT like a laser - then they can form orderly wave column like ENVELOPES which become steering "WAVE GUIDES" for much higher microwave and optical (light) frequencies. The skill to arrange these long wave STILL POINTS of both sonic energy and capacitive charge - is called STEERING YOUR CHI - in Tai Chi.

The DNA ultimately FOLDS ITSELF forging a RING DONUT.. in order to get the compression angles correct to cause the light ACCELERATION!



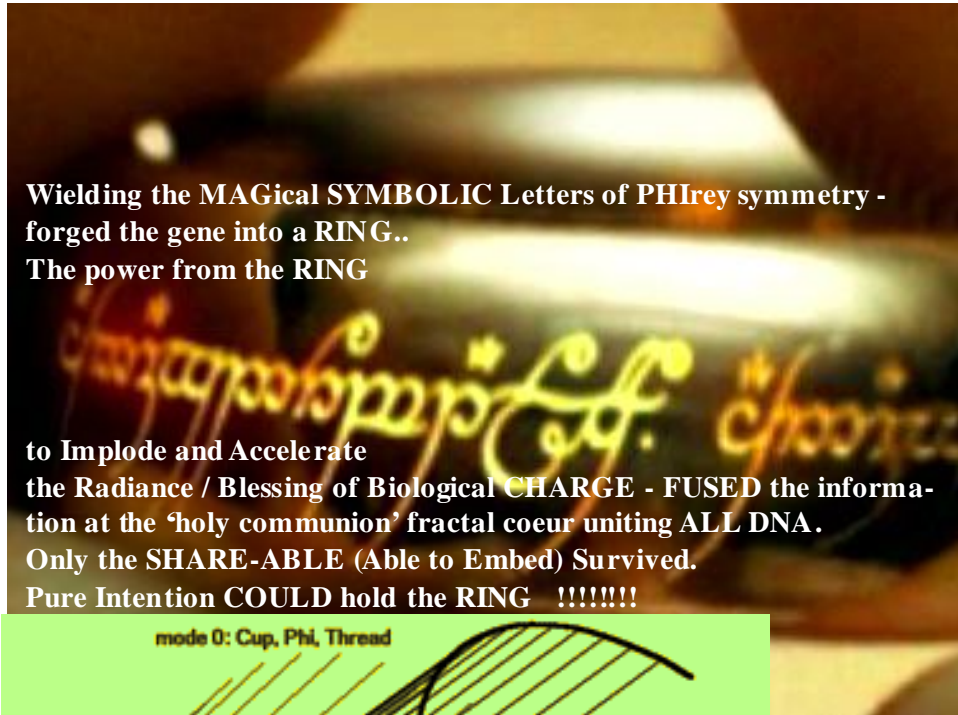
<http://www.aip.org/pt/vol-53/iss-9/captions/p38cap1a.html>  
<http://www.aip.org/pt/vol-53/iss-9/captions/p38cap1b.html>



**LORD OF THE RING - MOVIE: here is what it tells us about BLISS!**

**The true SCIENCE of getting DNA in blood into a ring - to implode: This is the real LORD OF THE RING meaning!**

**Getting your DNA to braid into a ring - is coded when waves of charge arrive at the right tilt angle to add spin compression to it. The index or look up table to the right tilt angles to add spin - is contained in the origin of the alphabet. The letters on the side of the ring.. ALPHABET are shadows of the spiral on the donut.. If you want to be a RING LORD - you will need the waves of charge in BLISS (Implosion).**



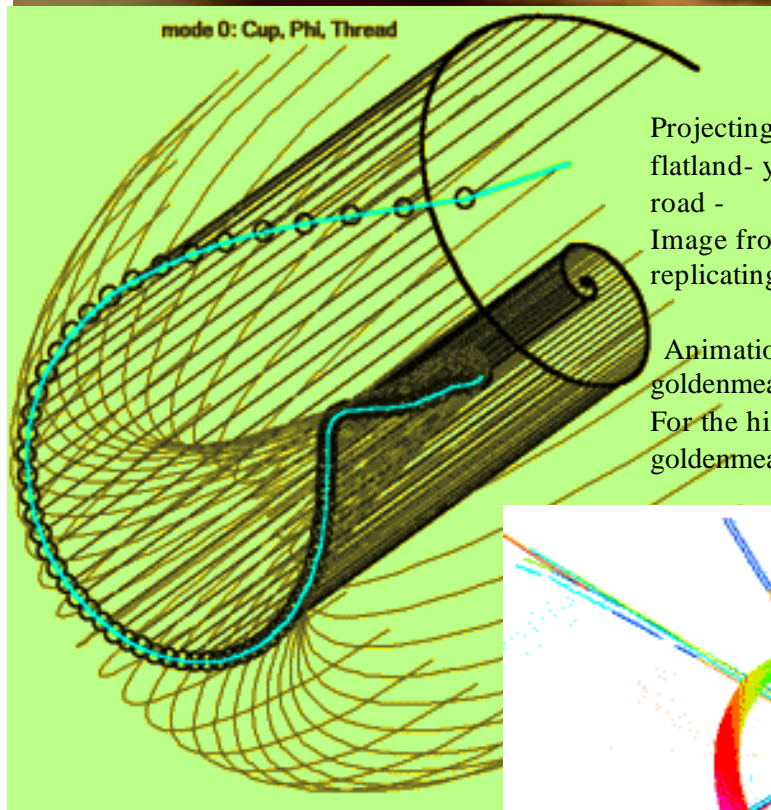
**Wielding the MAGical SYMBOLIC Letters of PHirey symmetry - forged the gene into a RING.. The power from the RING**

**to Implode and Accelerate the Radiance / Blessing of Biological CHARGE - FUSED the information at the 'holy communion' fractal coeur uniting ALL DNA. Only the SHARE-ABLE (Able to Embed) Survived. Pure Intention COULD hold the RING !!!!!!!**

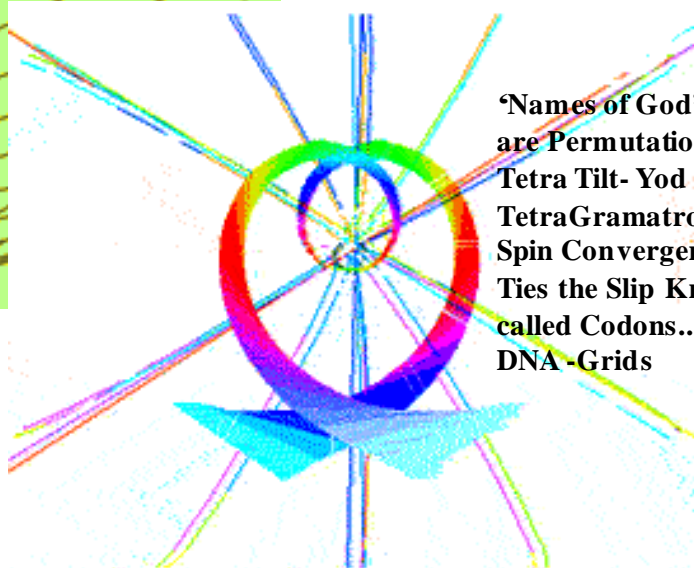
The actual letters Tolkien used to write Lord of the Ring - were supposedly derived from Finnish. This was one of the major destinations of the Dragon ancestors Sumerian Annunaki - (roots of H-Ibi Uru, and Arabic letters- see ). They had codified the angles of magnetism spin vortex into a software environment for programming DNA. Specifically - there were only certain symmetry angles at which you could add charge compression to the torsional slinky of genes. (see pic below).

The spiral map "element of flame" projected shadow of spin compression - when seen from the symmetry faces of the Tetrahedron - are Hebrew(H'Ibi-Uru) alphabet.

Those tilt views were the machine code software environment of the central hive computer ASHTAR. They were the only world known to Enlil (Yalweh) - whose use of them on DNA produced only - a Tetrahelix - Golem - No soul.

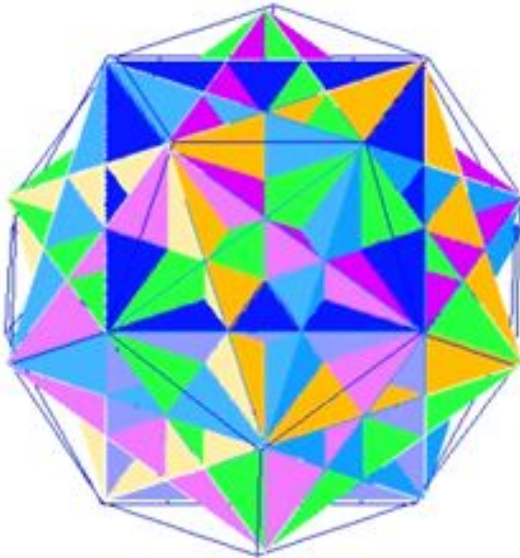


Projecting the spiral from flatland- yellow brick road - Image from Ted Small - replicating Dan' work. Animations & detail at: goldenmean.info/dnaring For the history: goldenmean.info/enki

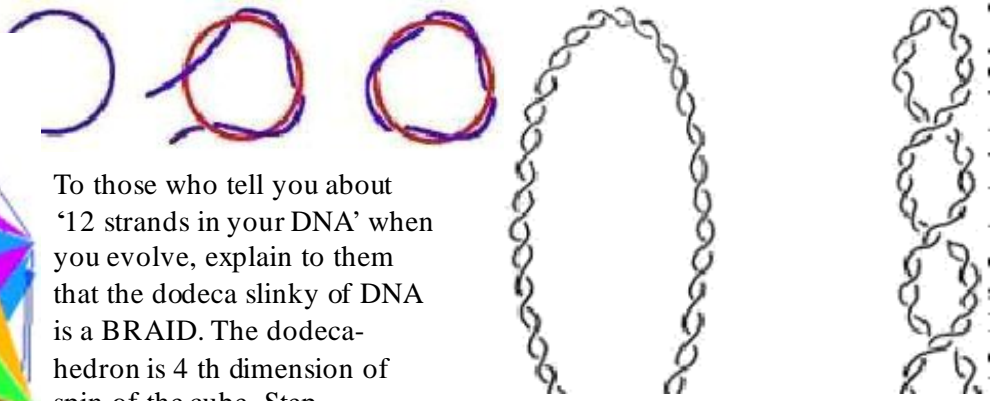


**'Names of God' are Permutation of Tetra Tilt- Yod He Vau He.. TetraGramatron - Spin Convergence Ties the Slip Knot called Codons.. DNA -Grids**



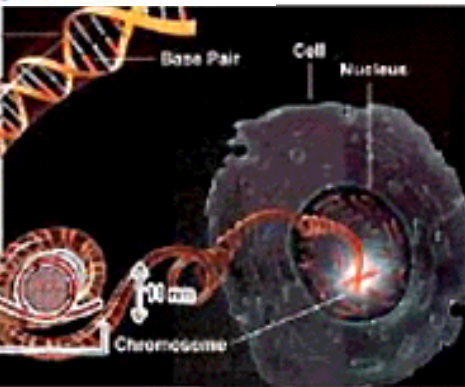


To those who tell you about '12 strands in your DNA' when you evolve, explain to them that the dodeca slinky of DNA is a BRAID. The dodecahedron is 4th dimension of spin of the cube, Step (wrratchet) that down a slinky into DNA-to 5th DIMENSION, .. THEN BRAID THAT 7 MORE TIMES!=12

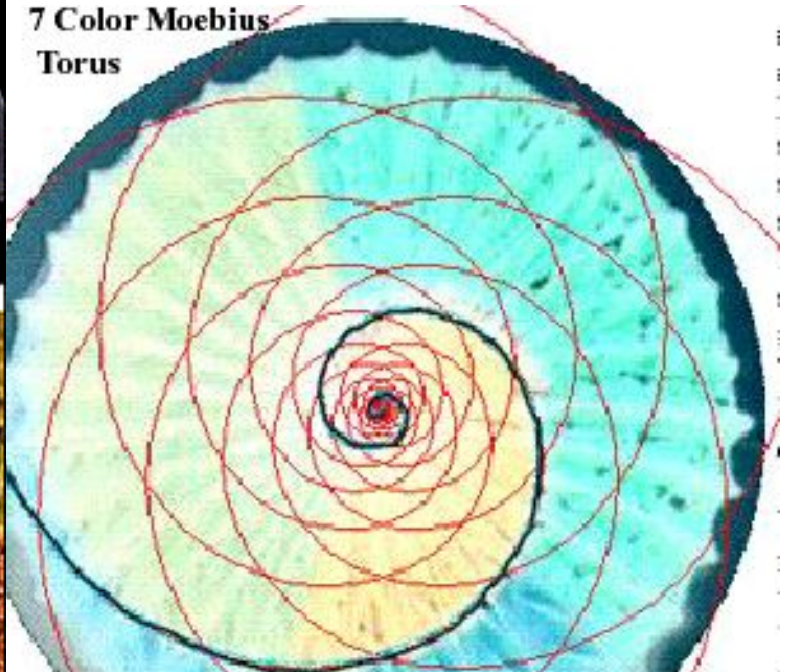


How the DNA in your blood- turns around- even turns inside out! to make your LORD OF THE RING seen in RING or DONUT DNA DNA is NOT a "Double Helix"# #By Ken Biegeleisen#, New York, N.Y. see: goldenmean.info/ringlord

"The Answer Lies Folded in an Envelope" Braiding Carrier Wave to Envelope Adds "Dimension" to DNA



7 Color Moebius Torus

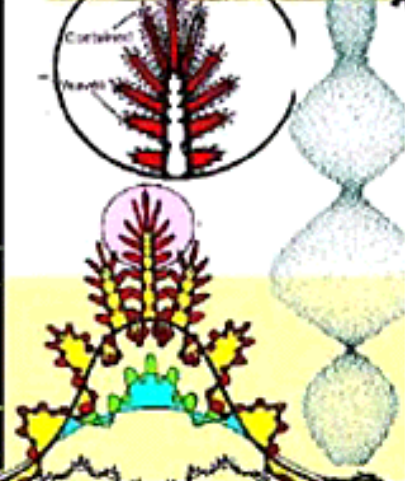
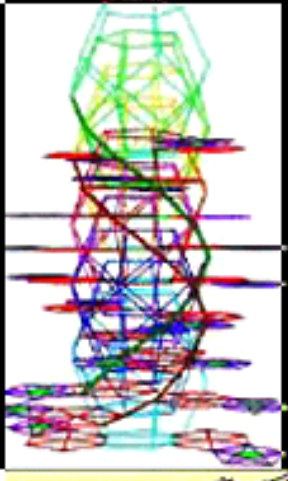
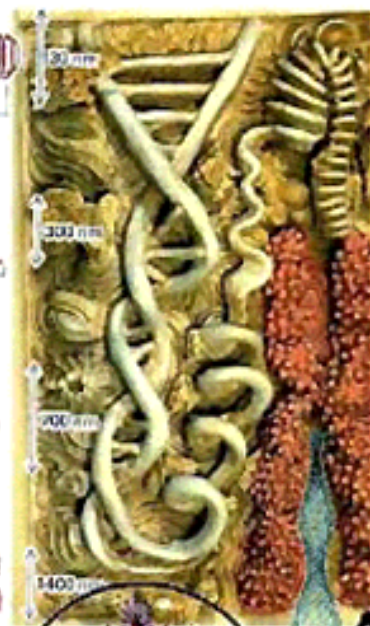


Above Here- How the Spiral Compresses Charge into GENES by Getting the ANGLE RIGHT.. This is a TOP DOWN VIEW OF DNA & the Spiral on Donut which made Alphabets.

Supercoiling DNA excerpt from <http://www.uovs.ac.za/faculties/nat/mkbc/biochem/Super.htm>

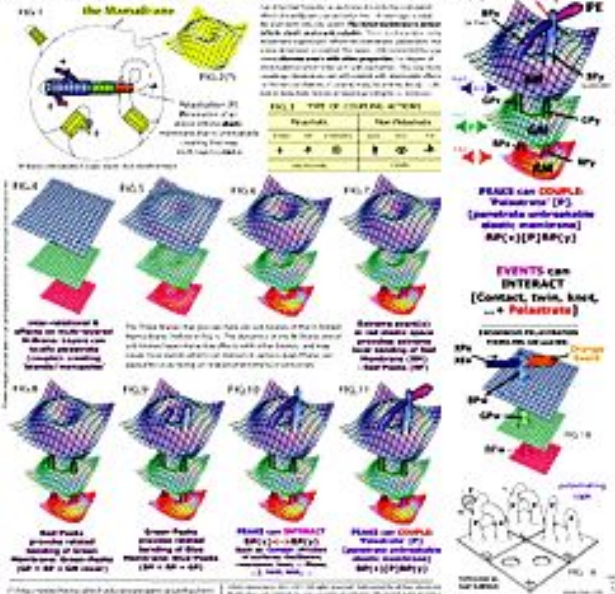
next page:

THE UNIVERSE IS ONE GIANT SQUISHY DONUT SURFACE - THAT KEPT TURNING INSIDE OUT! (advanced readers see "Laws of Form" derivation of calculus then ask 'How does one cell learn another's skills by eating the other cell- book- "ShuffleBrain") Is this RECURSIVE TURNING INSIDE OUT - (What Dirk Laureyssens -see [hollywood.org/cosmology](http://hollywood.org/cosmology) beautifully describes as Pelastration in his COSMOLGY) EXACTLY WHAT HAPPENS TO DNA? - to become LORD OF THE RING..



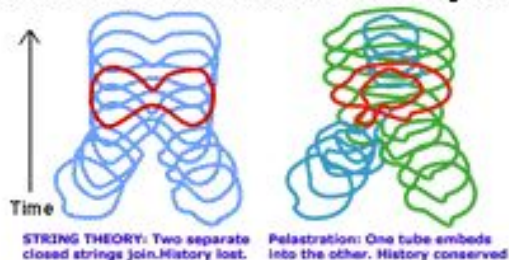


**CAN ONLY ONE BRANE CREATE A MULTITUDE OF SUB-BRANES AND EVENTS**

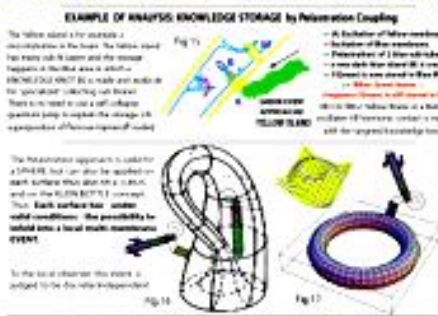


page 1. GR Tensors?

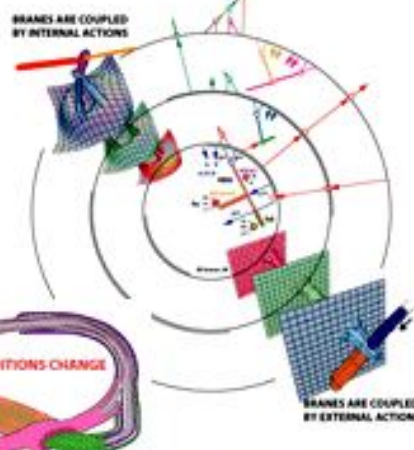
Difference with the traditional String theory:



**STRING THEORY:** Two separate closed strings join. History lost. **Pelatraction:** One tube embeds into the other. History conserved

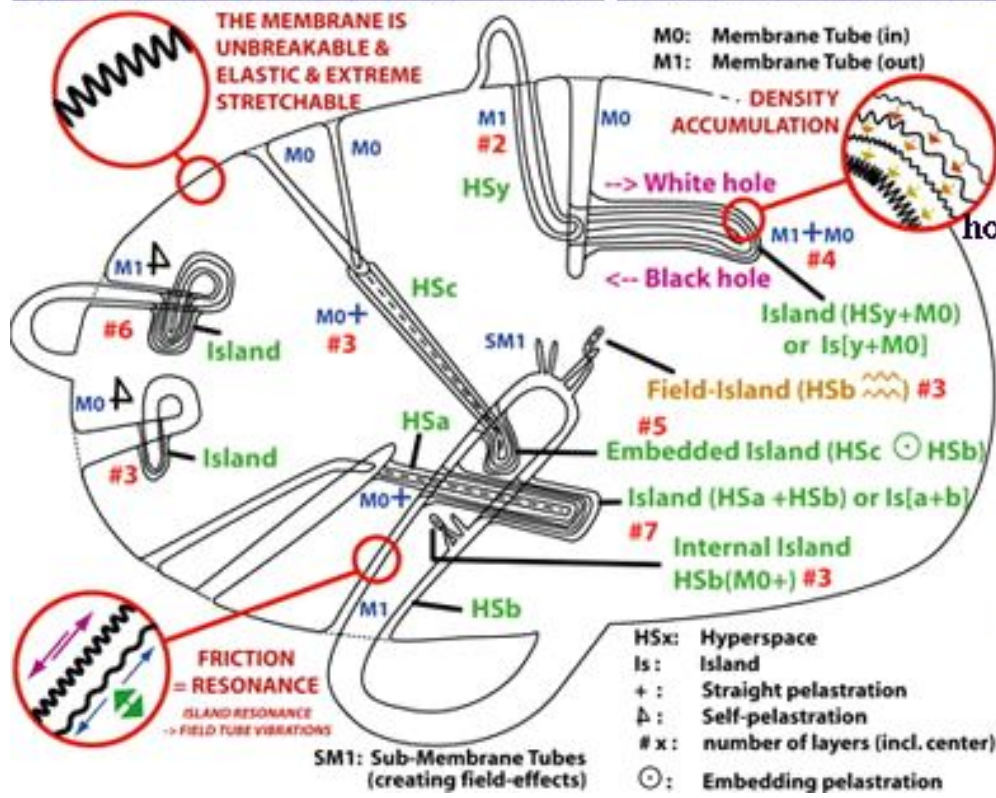


By pelatraction coupling the membrane restructures in various sub-branes. Here we see three sub-layers coming from only one brane. The concept is found on the first pdf file. On both sides of the brane coupling can happen.



**MECHANISM OF CONSCIOUSNESS AWARENESS & SUB-CONSCIOUSNESS**

Page 3. Pelatraction and the Klein Bottle? Page 4: couplings on the brane



Dirk Laureyssens  
[hollywood.org/cosmology](http://hollywood.org/cosmology)  
 Cosmology clearly develops EMBEDDING and Recursive Turning Inside Out he calls PELATRACTION to UNIFY the FIELD



47

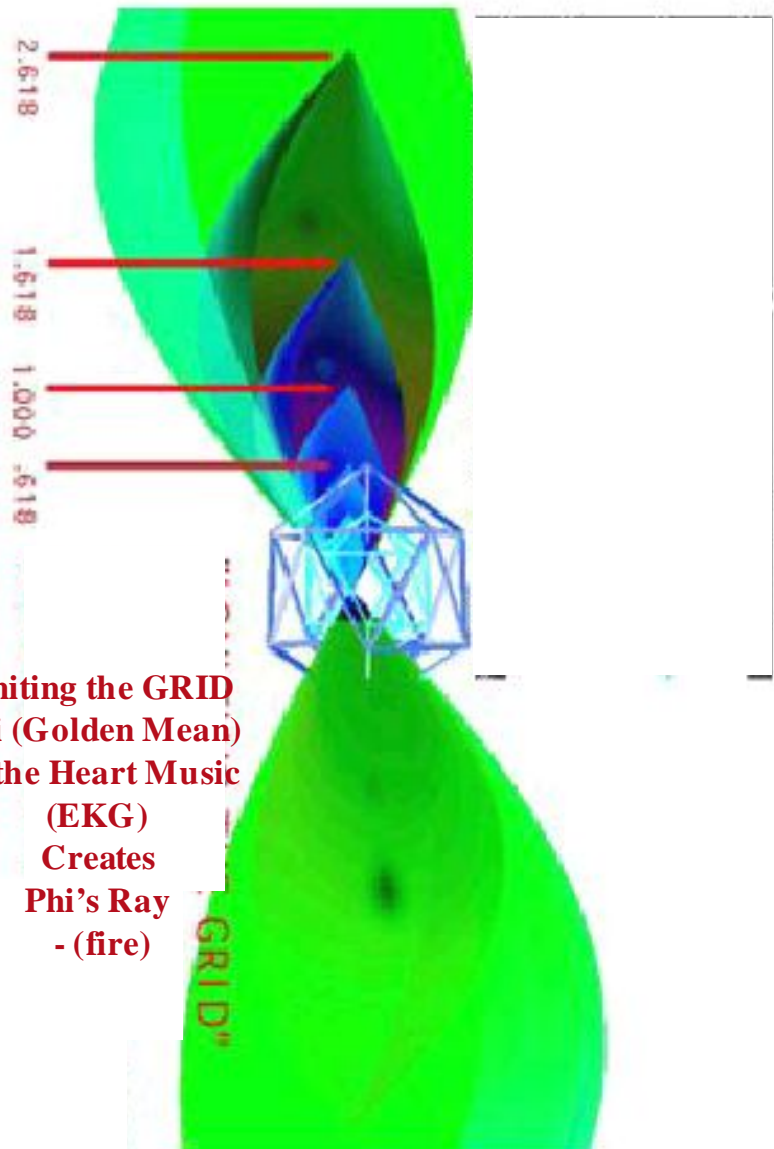
A "Magnetic X"  
details:  
[soulinvitation.com/  
magneticx](http://soulinvitation.com/magneticx)

The DNA molecule is shaped like a twisted ladder.

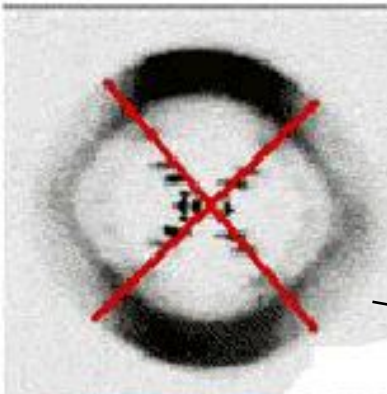
The distinct X shape in this X-Ray photo is how  
Watson & Crick discovered the DNA was a HELIX.

This is a drawing similar to what you see in a microscope  
of the MAGNETIC X shape of the CHARGE radiating  
from DNA during CELL DIVISION.

Eye-see. Vee seek a PI that sees/ Vesica Pisces  
Is Perception the Compression that Sorts  
- by Accelerating only what IS Shareable?



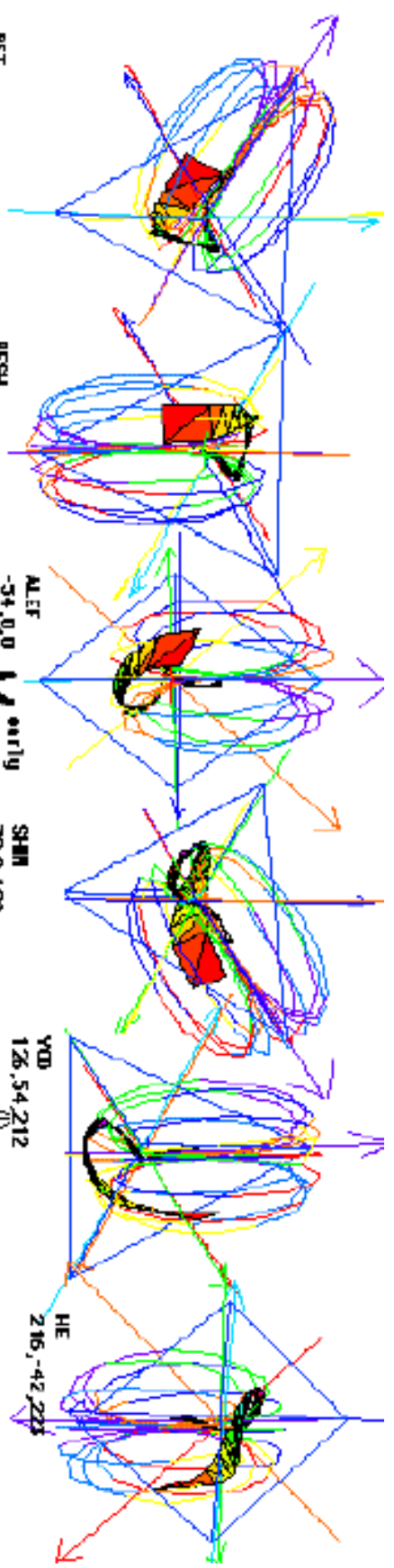
Igniting the GRID  
Phi (Golden Mean)  
in the Heart Music  
(EKG)  
Creates  
Phi's Ray  
- (fire)



BERAESHITH..(The first word of Genesis):  
 " in the beginning.. "  
 or more correctly: " at first in principle.. "

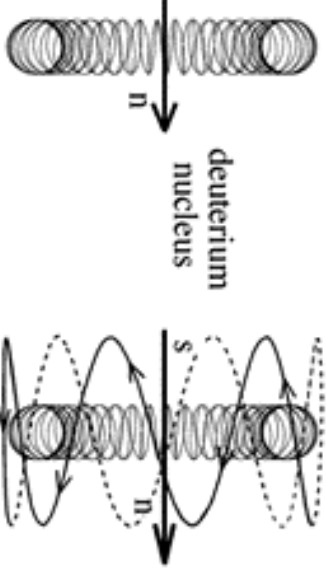


(Beginning of the Bible in Hebrew)



**CREATIVE SLIP-KNOTS:** Walking around an 8, requires 8 right turns.. (90 degree) - BUT .. if you walk around a donut.. it requires only **SEVEN** turns to turn inside out! (the 7 symmetry mirror arrows of TETRAhedron) .. **COMPARE WITH THE 7 Circuit Labyrinth.** Here, by simply starting at the outside of the donut and walking toward the inside (turning inside out) what see looking straight to center through our feet, as we change viewpoints (**TURN OF MIND**), **ARE** the Hebrew letters of the first word of Genesis - Beraeshith. Fabre D'Olivet's famous (Hebraic Tongue Restored) translation for this word- **THE PRINCIPLE OF THE BEGINNING OF THING-NESS -- IS THE PRINCIPLE OF TURNING INSIDE OUT** - on the surface of a donut. - origin of **ALPHABET ANIMATIONS** <http://spirals.etermite.com>

Millenium Twain freships.com (<http://free.freespeech.org/rapture/>) creation ) shows us that the Heart of Hydrogen (Deuteron ) is **DUMBBELL** or **DONUT** Shaped. Hydrogen's heart we have seen in the ANU as the same shape as the Heart of the Sun AND the Heart of the Human! Confirming that this geometry of the perfect **FUSION** slip-knot is donut like - helps us revisit the **HOW TO TURN INSIDE OUT QUESTION.**

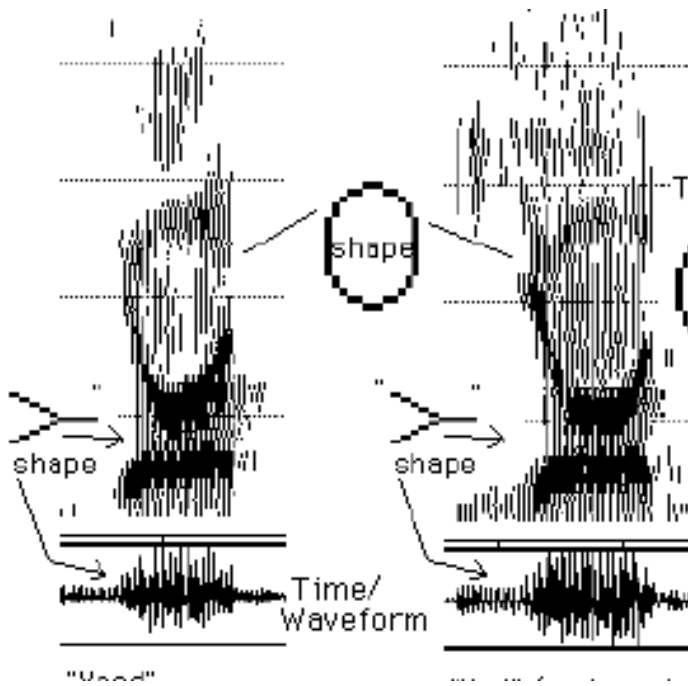


deuteron (proton + neutron) is dumbbell-shaped, with magnetic radius twice the lateral radius! (1.5 fermi by 3.0 fermi) \*



Here are some images to help you visualize how the SOUND and the shape of AAAleph (first letter in Hebrew)

yesus AAYIN (our Y) do in truth AAA EEEE Dent i PHI (identify) point in - or create -



The beginnings of shape?

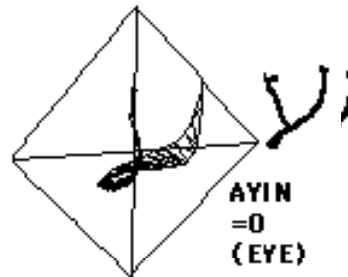


Shadow Painting

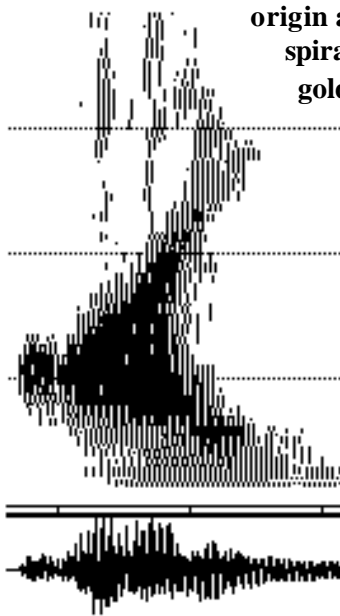
"Y"od?

origin alphabet from embedding spiral on donut animations: [goldenmean.info/dnaring](http://goldenmean.info/dnaring)

AYIN 36,42,137



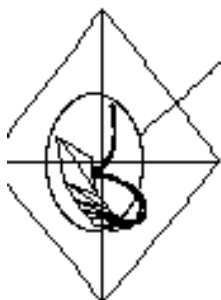
THE PLACE WHERE THE EGG IS DIMPLD . To begin the DIMPLING - is to MAKE HEART & MAKE FERTILE!



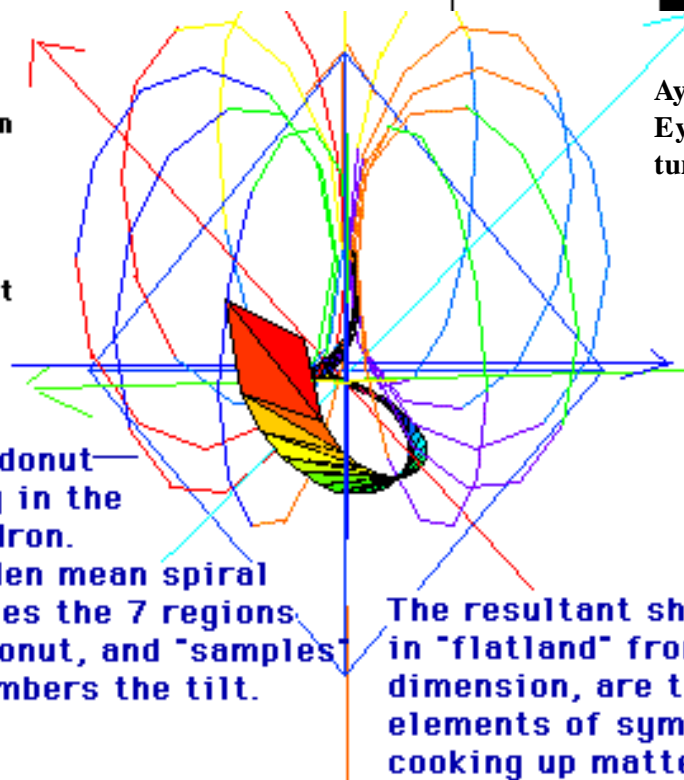
Shadow Painting



ALEF -54,0,0



early written form = A Aleph  
current form

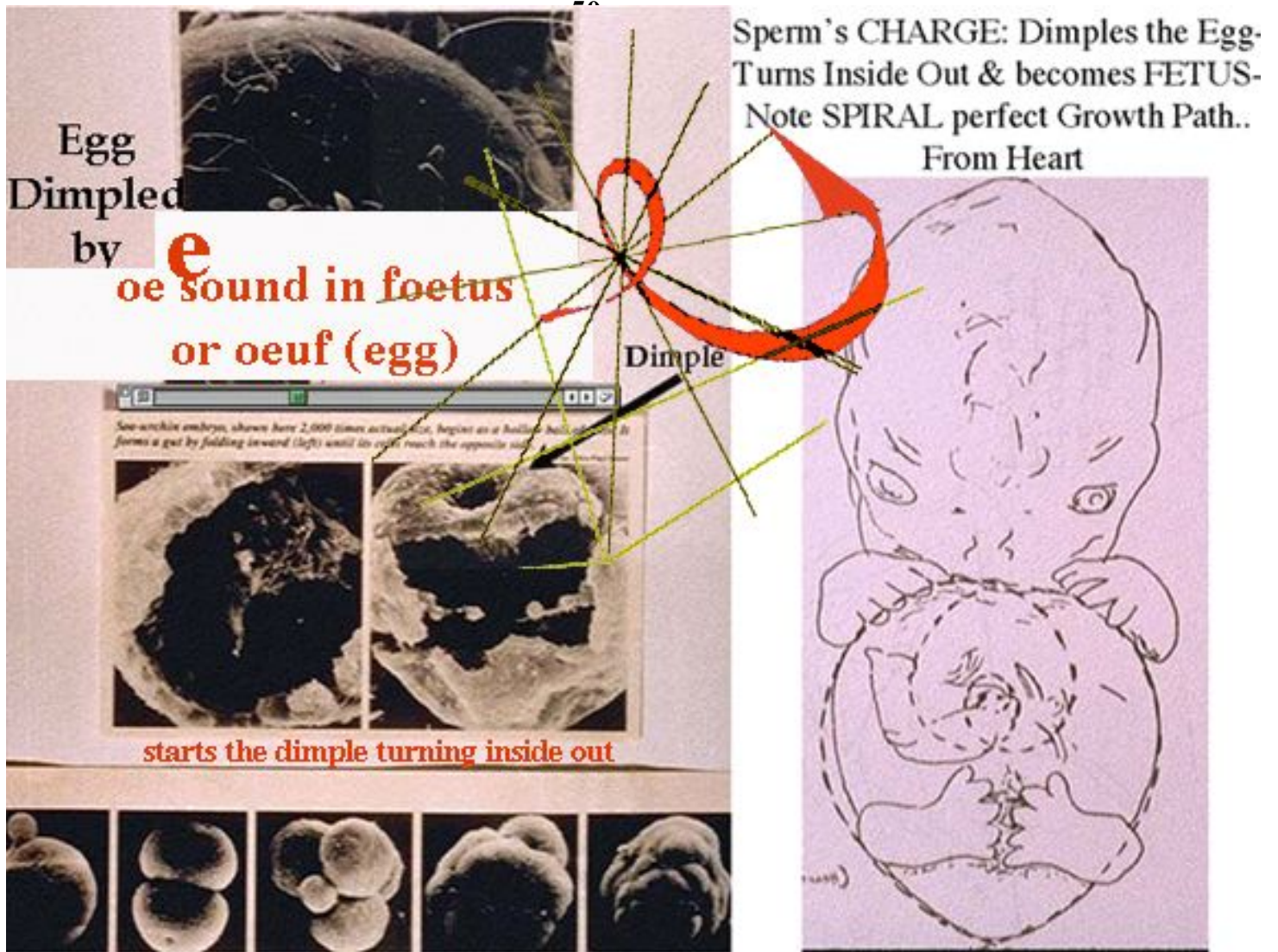


Ayin - the Y is the Eye where the thread turns inside out!

The resultant shadows in "flatland" from the next (spin) dimension, are the sacred or timeless alphabet elements of symmetry, for cooking up matter out of light donuts.

7 Color donut spinning in the tetrahedron. The golden mean spiral delineates the 7 regions on the donut, and "samples" or remembers the tilt.

The resultant shadows in "flatland" from the next dimension, are the sacred elements of symmetry, for cooking up matter out of light.



WHY does oe- dimpling the egg - MAKE FERTILE / FECUND: WORD ORIGINS: are SPIN MAPS- here for **foetus and oethel** (ancient English ex: onomatop(oe)ia) from **Druide informatique inc.**

oethel - **Œ** like : **oeuf, oeil, coeur, voeux, noeud, oesophage, oedème**

French for - **EGG, EYE, HEART, WISHes, KNOT, Œsophagus, (The THROAT is where the donut turns itself inside out!)** **More here - traditional English and the oe sound:**

fetus (fœtus)- 1398, from L. fetus: the bearing, bringing forth, or hatching of young," from L. base \*fe- "to generate, bear," also "to suck, suckle" (see fecund). In L., this was sometimes transferred figuratively to the newborn creature itself, or used in a sense of "offspring, brood" (cf. "Germania quos horrida parturit fetus," Horace), but this was not the basic meaning. Also used of plants, in the sense of "fruit, produce, shoot." The adj. fetal was formed in Eng. 1811. The spelling foetus is sometimes attempted as a learned Latinism, but it is not historic.

fecund - c.1420, from O.Fr. fecond, from L. fecundus "fruitful, fertile," from L. base \*fe-, corresponding to PIE \*dhe(i)- "to suck, suckle," also "produce, yield" (cf. Skt. dhayati "sucks," dhayah "nourishing;" Gk. thele "mother's breast, nipple," thelys "female, fruitful;" O.C.S. dojiti "to suckle," dojilica "nurse," deti "child;" Lith. dele "leech;" O.Prus. dadan "milk;" Goth. daddjan "to suckle;" O.H.G. tila "female breast;" O.Ir. denaim "I suck"). Also from the same L. base come felare "to suck," femina "woman" (lit. "she who suckles"), felix "happy, auspicious, fruitful," fetus "offspring, pregnancy," fenum "hay" (probably lit. "produce"), and probably filia/filius "daughter/son," assimilated from \*felios, originally "a suckling."

egg (n.) **oeuf-** c.1340, from northern England dialect, from O.N. egg, which vied with M.E. eye, eai (from O.E. æg) until finally displacing it after 1500; probably from PIE \*owyo-/\*oyyo- "egg"



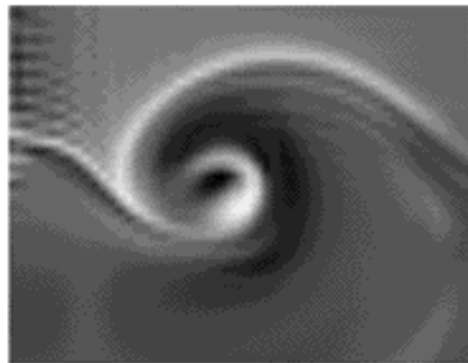
**SECRET OF GRAVITY**

Einstein once said that if he could figure out the shape of how waves collapse or compress perfectly into each other (without interfering) - then he would have the secret of gravity. Einstein died without figuring this out. This book is going to show you a beautiful simple truly accurate answer to this problem that stumped Mr. Einstein. (The "Holy Grail" of Gravity).

**Implosion Exists Because In The Geometry of "SELF SIMILARITY"  
- It is Possible for a Wave to Re-Enter ITSELF - Non-Destructively.  
Ability to SELF-REFER  
is the Vedic definition of CONSCIOUSNESS.**



The GOLDEN MEAN  
SPIRAL  
Is Self-Similarity  
Perfected  
For Wave Mechanics



In Hydrodynamics- This is called:

“Optimized Translation of Vorticity”

It means - this is the only way for Inertia in a line to be “translated into a circle”. Since the inertia created by waves in rotation is the ONLY definition for MASS - this translation is by definition the perfect path from MASS to ENERGY. **Later we use Spectrum Analysis to Measure This**

Now you should be asking - why should we tell KIDS to answer the problem that Einstein died without solving! How could we possibly want our bright 11 year old to understand that. You probably have never even learned what the world physics MEANS! ( It means: "Cycles of PHI" - which is a word for the geometry of THE GOLDEN MEAN - We are going to have a lot of fun with this GOLDEN MEAN - number - sometimes called PHI - pronounced like the FIE in FEE FIE FO FUM (in “I smell the blood of the English Mun” see Jack & the Bean Stalk).

There is an important reason you need the answer to the problem about gravity and the unified field - which wise Albert Einstein couldn't answer . The reason is - that in order to understand how your bliss and ecstasy and enlightenment is going to make you into a STAR!!! -- you need to know how to collapse waves perfectly TO MAKE GRAVITY! (inside yourself)

Don't worry -- it's not even hard. In fact - **every time you feel that very special rush and tingle that comes when you REALLY FEEL LOVE for somebody - you are DOING IT! The kool thing is that now we understand the SCIENCE OF WAVES - that PROVES - that LOVE MAKES GRAVITY.**

This is the wonderful part about my little invention called the Heart Tuner. (Because it helps you choose to TUNE UP YOUR OWN HEART to sing better). You can read about it at heartcoherence.com . The point is that **there is a certain music your heart makes when you feel love and compassion.** This musical 'recipe' or

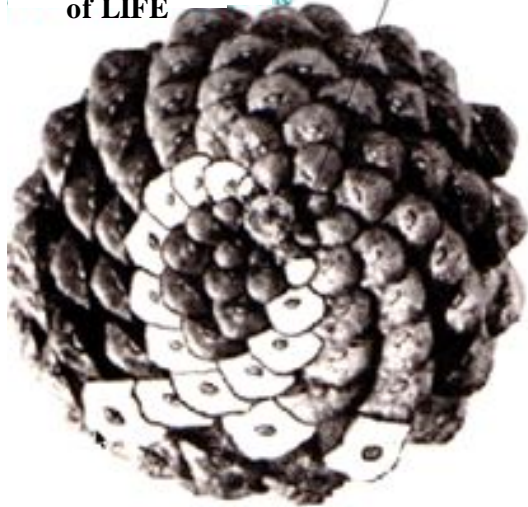
Thru this  
IMPLOSION  
Or ZERO  
Point  
ONLY  
The  
SHAREABLE  
Or ABLE TO  
GET IN  
PHASE  
WAVES  
SURVIVE..

How IMPLOSION /  
FUSION .. SORTS...



Surviving this Charge Compression  
In DNA is the Key  
to Successful Dying

Implosion  
Zero Point  
Pine Cone  
"Phire"  
of LIFE



**Implosion Paths for 'Charge' seen in the 'Projective Geometry'**

**Around a pine cone - adapted from "Vortex of Life"**

**by Lawrence Edwards..**

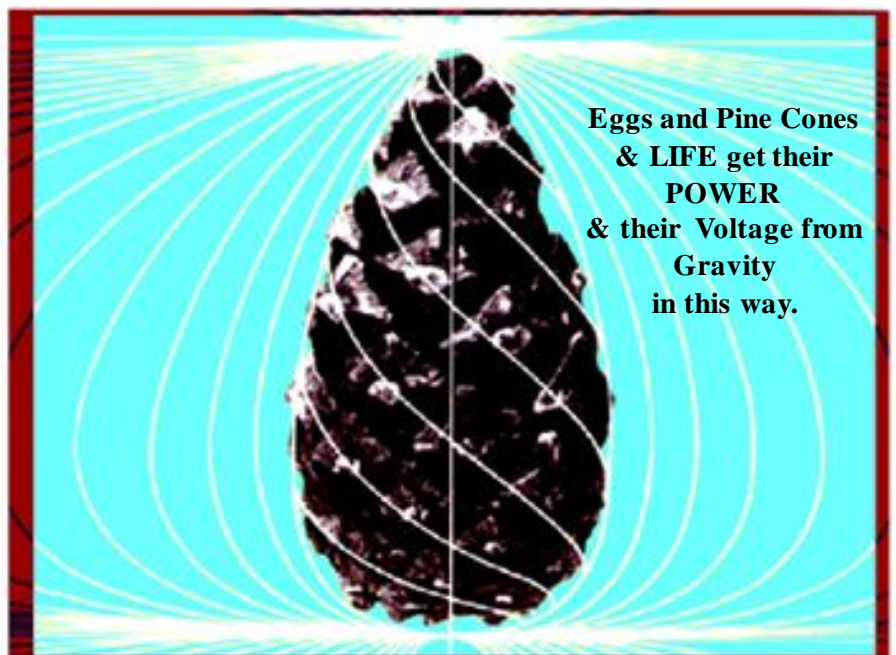
**The principle of perfect braiding, or 'pining away' is the steering  
of flow to a universal meeting or fusion or implosion point.**

**From that 'point of perfect  
meeting' all waves EMERGE  
SORTED..**

**Only 'shareable' waves which can  
agree and get in phase survive..**

**This illustrates how implosion  
becomes the principle of sorting  
for waves in general.**

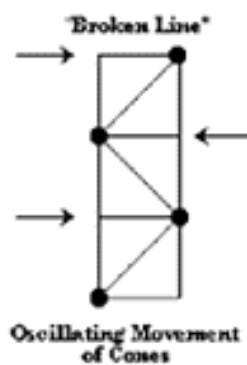
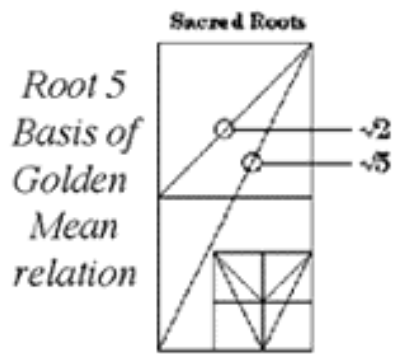
**In physics - this principle is called  
'fusion' and 'phase conjugation'.**



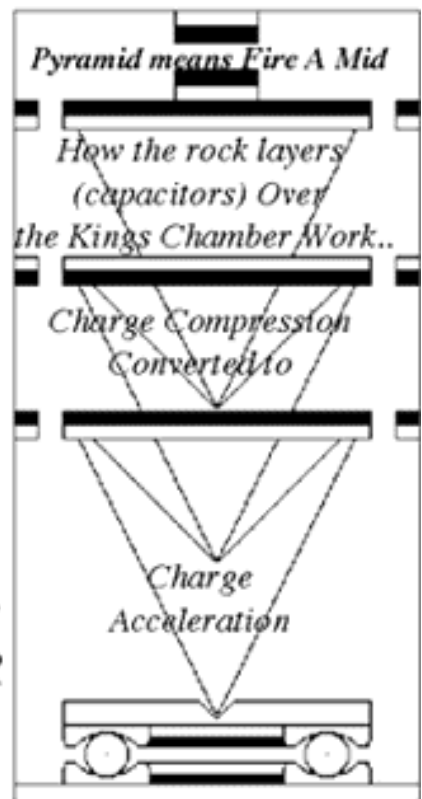
**Eggs and Pine Cones  
& LIFE get their  
POWER  
& their Voltage from  
Gravity  
in this way.**



*CHARGE waves  
in a pine cone  
make gravity!  
So does  
your heart..  
and a pine cone.*



**Egyptian Djed**



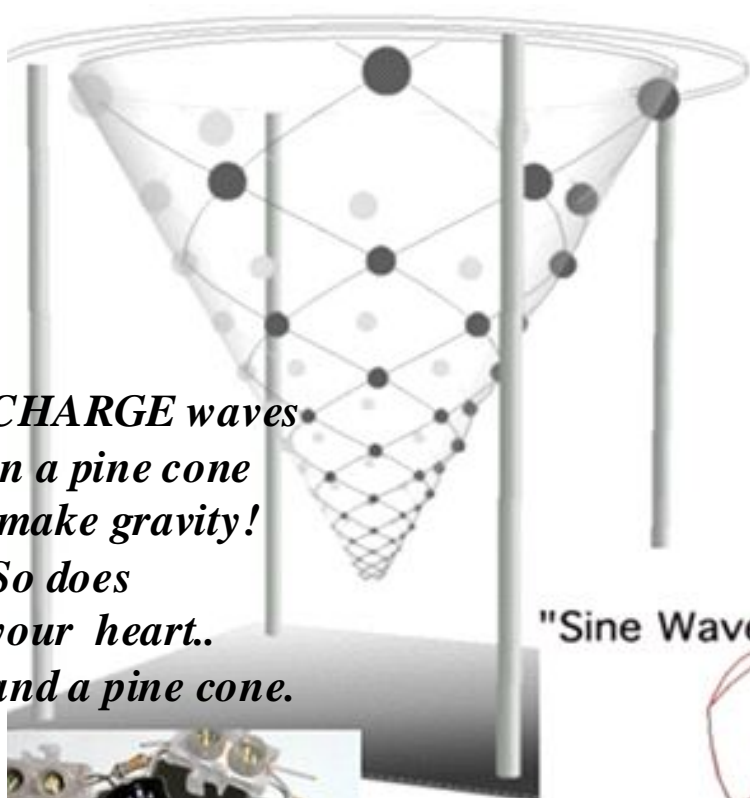
*Also:  
'Mygdala':  
To TOWER*

*French "Naudin" Gravity Thrust  
Device - by Capacitors Arranged in Cone*

*Originally inspired by the geometry  
Of Egyptian Concept "Djed"*

*Raising of the Djed - versus- Djedai Knight..*

*Compare to Sword and the Stone... Creating ~Vertical Component  
To Magnetism originally in rotation.. (Golden Ratio Path -  
Translates Vorticity from Circle to LINE..)*



Here in the top down view of you DNA.. we see GOLDEN MEAN turning COMPRESSION in to ACCELERATION.



"Sine Waves"

GOLDEN MEAN RATIO

PERMITS ADDING AND MULTIPLYING OF WAVES



musical collection of the hearts different sounds carefully put together - actually makes waves compress and collapse into each other perfectly (during passion and COMPASSION). **LOVE MAKES GOOD SQUEEZING.. you knew that the first time you felt a really good hug!**

When you start compressing and collapsing (your heart) waves into each other totally **without any interference** - they implode. This is the opposite of explode. This creates the suction for waves into the center CALLED GRAVITY! This implosion is a name for the correct geometry or shape pattern that lets waves change COMPRESSION in to ACCELERATION, In science - acceleration (like speeding up in an elevator) is the same thing as gravity . This magic Golden Mean number - we are going to talk about ( geometry based on 5 sided stars..) is the key to this collapsing to center of waves which makes gravity. We could joke and say this idea is 'kind of HEAVY'.

The reason GOLDEN MEAN allows squeezing (compression) to tum in to acceleration - is because of one of the neat qualities of this number. The .618.. series (see this picture) is kool because you can add 1 to 1.618 for example to get 2.618... OR you can MULTIPLY 1.618... by 1.618.. to get 2.618. This is the only number in the world that does both!

Recursive Heterodyning  
Is the Constructive Wave  
Interference Which  
Produces Implosion /  
Self-Organization

*Bliss in the Heart: Varying the tilt angle which the heart's vortical muscle was 'charge coupled' or lock in (here, into and out of the plane of this paper) of the vortex cascade or "light cone" - would determine this critical RATIO between nested magnetic fields. When perfected into IMPLOSION or perfect FUSION - this cascade continuously sweeps information (charge) from planets - gravity bodies, to glands, to cells, & DNA!*

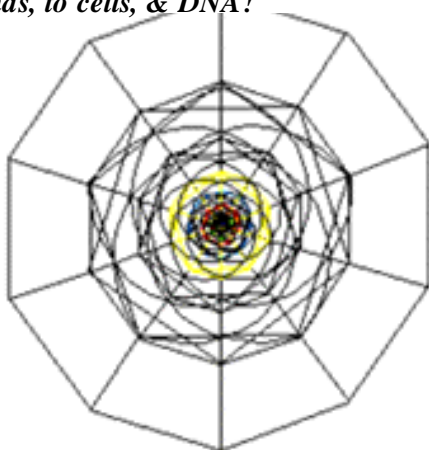
Waves must BOTH Add & Multiply in order to produce only CONSTRUCTIVE interference.

Golden Ratio

©18 series & recursive heterodyning

.618...	Add 2
1.0	To get
1.618..	The next
2.618..	OR
..	Multiply
	Any one
	Number
	Times
	1.618..
	To get
	The next.

Here  
Is where  
Compression  
Becomes  
Acceleration..  
'squirting'  
Thru the  
Speed of  
light



As we see the heart in love AND the touch ("Sentic") that says love both use GOLDEN MEAN. This means that when you feel love and compassion you make the gravity which holds lovers and stars and atoms together!

All this would seem just too much like a fairy tale except for one thing. We can MEASURE IT - and prove it - and it is real science. (Real science refers to an idea in a language which is so accurate and precise that the idea can be measured, repeated and therefore is TOTALLY SHAREABLE).



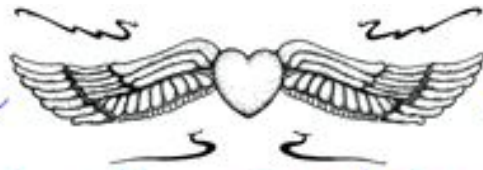
If we arrange electric waves in the shape (the 'symmetry' - the 'wave music') you make in your heart when you feel love - then we actually MAKE GRAVITY. ( pictures at goldenmean.info/thrust and goldenmean.info/einstein )

Are we saying that the solution to the problem that messed up dear Einstein is so simple that a child should understand it? The answer is YES! A child NEEDS to understand it - and the pictures make it easy. AND when you DO understand how to squeeze waves into each other so good that they MAKE gravity.. THEN you ARE ready to make stars from your heart. (Become a SUN GOD- because anything less just is less fun). Don't get afraid that we are 'chewing off more than we can bite' . **Digestion (understanding) equals fusion & sorting brought to the fire of implosion / bliss!**

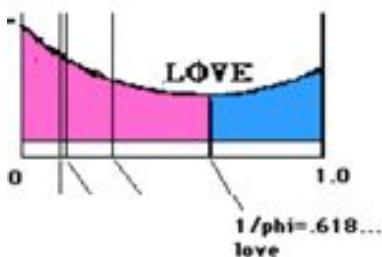
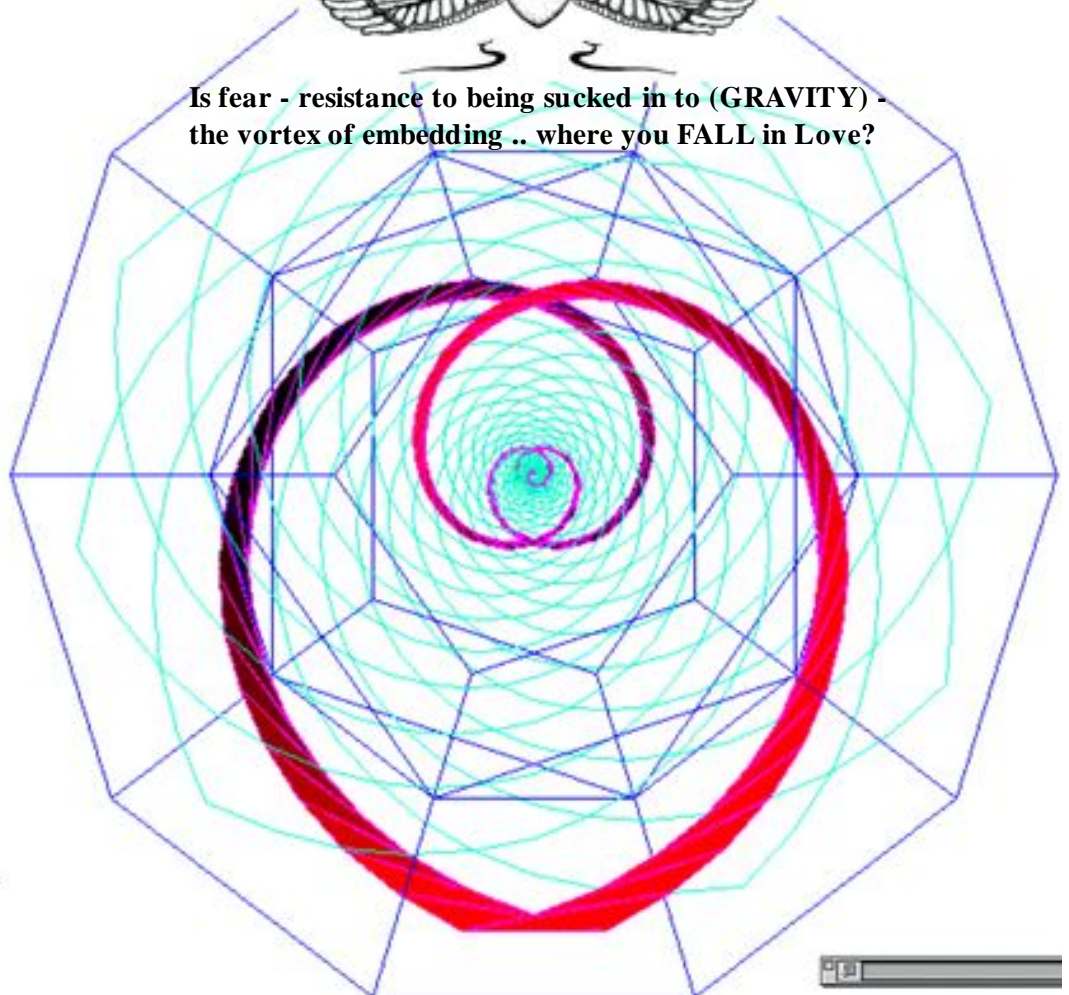
We are going to do this whole trick - of showing you more about making GRAVITY using (BLISSFUL) LOVE IN YOUR HEART - with LOTS AND LOTS OF FUN PICTURES.

And particularly don't be embarrassed when you are done here - that at 11 years old - you understand some science and physics better than scientists. It is those scientists who ought to be embarrassed - since up to this book- they did not even know **WHY things fall to the ground.** (Things fall to the ground because waves collapsing perfectly - think of waves arranged like rose petals - turn compression squeezing into a wave that speeds up. When you push the waves SPEED this way thru the speed of light - this creates what we call the 'bathtub drain' effect. The wave begin to suck thru the hole into light speed. This SUCTION for waves - this compression in to ACCELERATION - is called GRAVITY. We have more pictures coming up on this - goldenmean.info/phiricais ).

Non destructive unfolding of EKG Magnetics - Giving the Heart Wings..



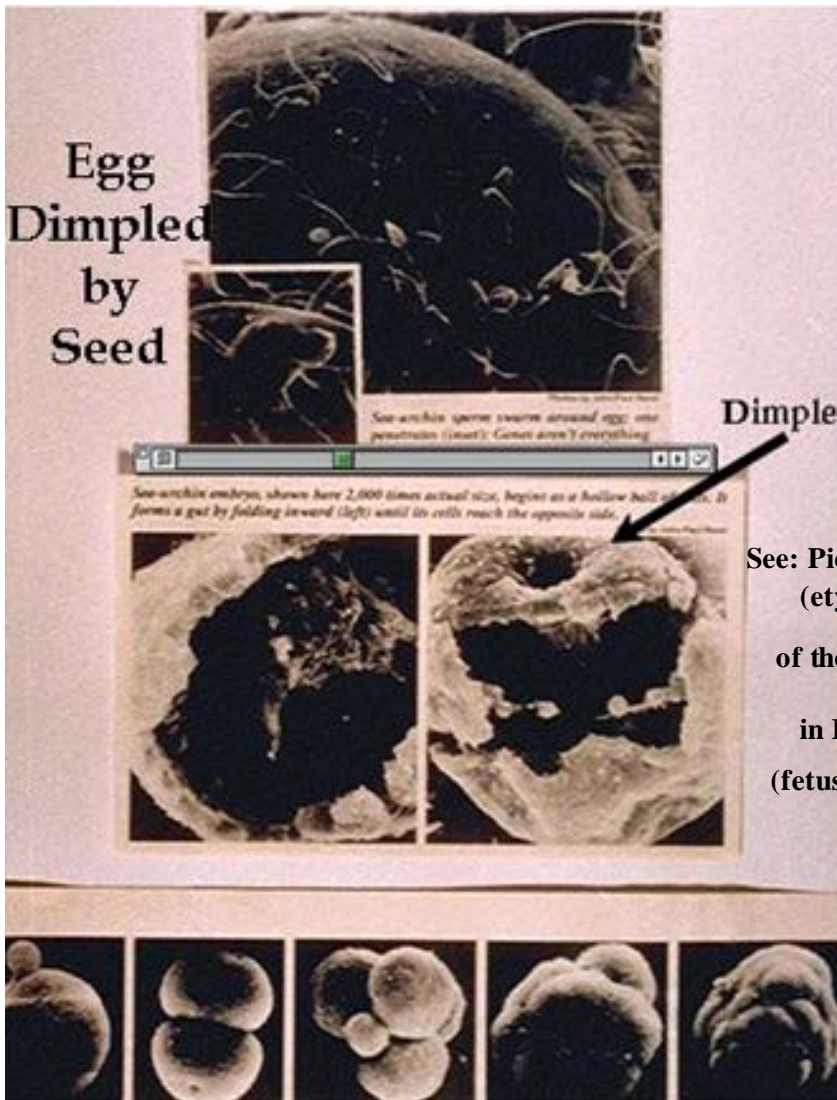
Is fear - resistance to being sucked in to (GRAVITY) - the vortex of embedding .. where you FALL in Love?



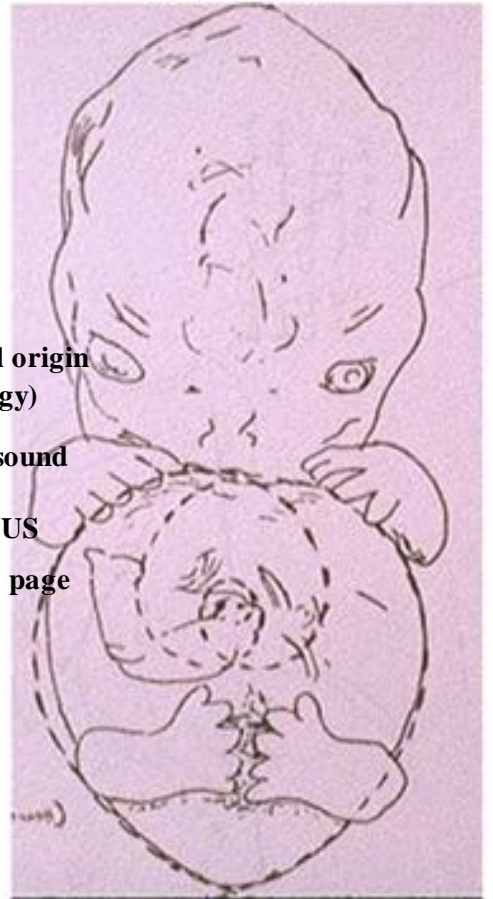
Unless you can explain the pure principle behind GRAVITY as waves - you cannot understand the pure principle of LOVE. Did you ever wonder why they call it **FALLING in love? IMPLOSION / BLISS / FIRE IN THE HEART - makes GRAVITY INSIDE YOURSELF. Free yourself from the Earth's gravity and matter, and even planet influences etc., (astrology). Instead of subject to the fate of all (a bit FATAL) you make your own fate. This is why the entering the V as in Vortex and (Roman V) FIVE-ness - makes VOLO - which is both to FLY and to have WILL. (Voluntary).**

Now you begin to see why on Earth - would we need to explain all this to kids!!! The principle that allows gravity to get made among (electrical ) waves - is absolutely the same as the principle (or RULE) that allows you to make BLISS AND ECSTASY AND ENLIGHTENMENT inside your heart and your head. And the shape of the picture of waves that makes this work - is something you can see and learn in a minute! Not only is all this the key to bliss - enlightenment - it is also the key to making ATTENTION happen inside your head. In this book - we are going to sometimes call these electrical waves which collapse and compress into a perfect center - waves of CHARGE. The shape of these waves of radiating (or spreading out) CHARGE - is what used to be called SPIRIT or CHI or LIFE FORCE.

For example what Christians call the AURA around saints is because the saints learned to attract and then radiate in order - more of these waves of electrical CHARGE. Some of you have heard of KIRLIAN photos- these are a way of taking pictures of your aura (your HALO). Your HALO is the shape of your waves of this charge - and you need to take RESPONSIBILITY ( take CHARGE) of this - so that you don't make messes in your aura and planet. This whole subject of **taking CHARGE of your emotion** so your aura creates pretty pictures and leaves trails of glory - is called COHERENT EMOTION. **People with confused emotion leave electrical pollution in the room when they leave. People with COHERENT emotion leave a sweet kind of smell in the room** - that has NOTHING to do with their deodorant. (continued page 57)



**Sperm's CHARGE: Dimples the Egg- Turns Inside Out & becomes FETUS- Note SPIRAL perfect Growth Path.. From Heart**



**See: Pictorial origin (etymology) of the Œ sound in FŒTUS (fetus) next page**



Coherence means- waves that spread out like a laser - instead of a weak flashlight. Waves that are coherent all march forward together in such a way that they can keep going. For example - coherent laser light will go all the way to the moon - your flashlight will not. If you want your heart to shine like a laser - so that you survive death with memory whole - then you need to learn to become COHERENT. This COHERENCE in your heart's music is what our neat little HeartTuner measures beautifully (heartcoherence.com)

SO - to be COHERENT here (to be FOCUSED), let's get back to HOW creation happens - now that we have some clues about why we need to **understand creation in order to make creation happen inside our hearts.**

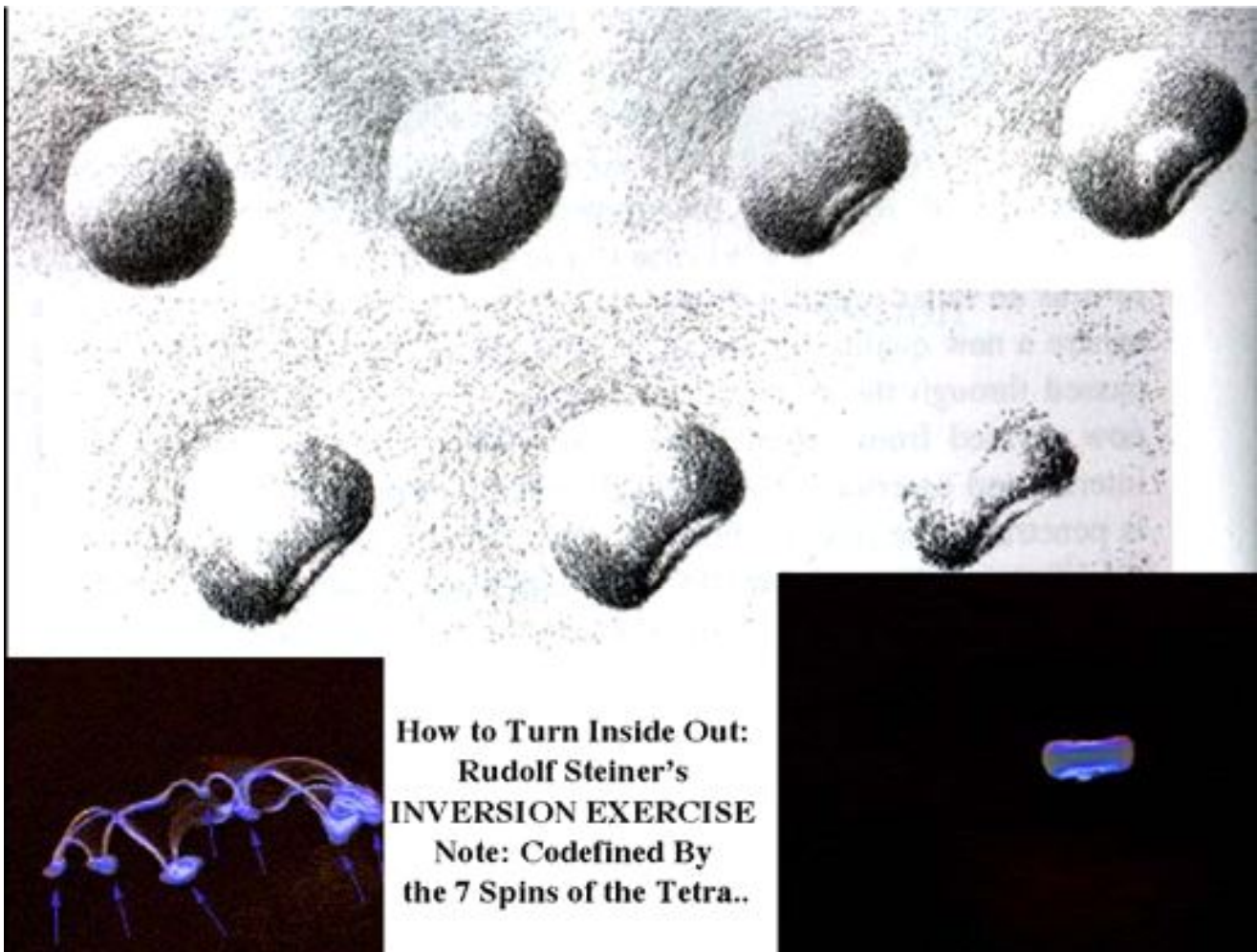
### SECRET OF LOVE..

"Only LOVE bends the Light - So only LOVE CREATES" (Old Sufi Proverb). Only creating suction to center of charge by compressing - making compassion - in your heart will attract waves from the line path energy - into their circle path- matter.

There is an ancient wisdom in the Orient (around China and so on). It says that the word SHEI (say it like SHAY- similar to the SHUI in FENG SHUI ) - means to DIMPLE and to MAKE HEART. Understanding the origin (the beginnings) of the universe is similar to understanding the way waves start to dimple.

**The PRINCIPLE or RULE is - that You Begin COMPRESSION - You Start Waves DIMPLING- and THAT IS WHAT MAKES HEART - because that is what sorts things out into ONEness!**

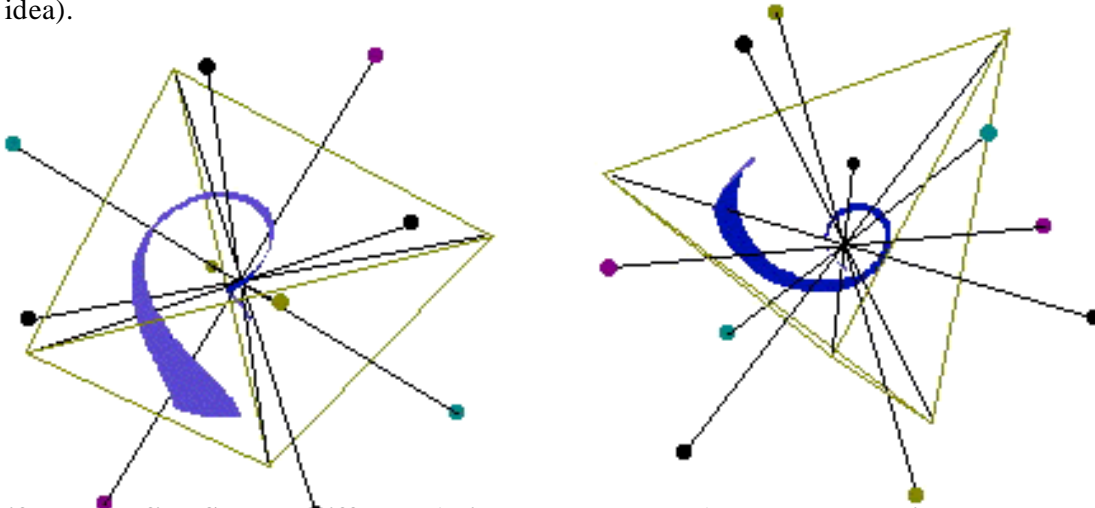
Suppose you were in a room, and you felt that people who were there before had been feeling angry and upset. You realize that something needs to change in the feeling - the energy in the room. This information about DIMPLING and MAKING HEART - gives us a clue about how to fix that room. You go inside your heart with your feelings - your focus. And there you hold an emotion inviting all the waves of that room IN to your heart. You feel all the sad and confused and maybe angry feelings that were shared in the room before - and you bring them ALL TOGETHER into ONE SPACE where they ALL CAN MEET - inside your heart.



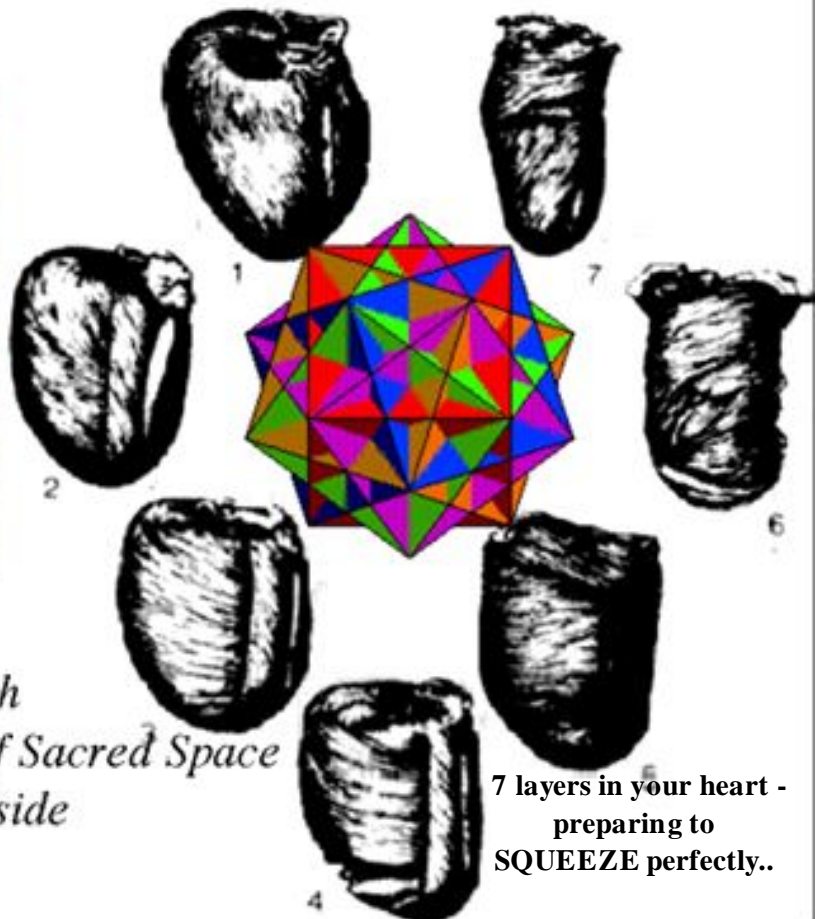
This is called **THE COLLAPSE PROCESS**. When waves (and FEELINGS ARE WAVES) - get all gathered together into one COMPRESSED SPACE - they begin to SORT THEMSELVES OUT.

The REASON waves sort themselves out - when they are compressed together- is because ONLY WAVES WHICH ARE SHAREABLE - that is waves which can spread out (or radiate) without hurtful INTERFERENCE with each other - can make it thru the center. This means that - from the other side of your FOCUS- only the SHAREABLE survive!

This is fun because the idea of PURE INTENTION - usually used only to describe FEELINGS - suddenly becomes something that scientists can talk about! You see - it turns out that **COHERENCE is also - a name for only the waves which can spread without interference**. And (thanks to our new invention - HeartTuner heartcoherence.com) COHERENCE in your heart can be MEASURED! This means that literally we can check the music in your heart beat (called Electro-Cardio-gram - EKG) for PURE INTENTION! (A pretty kool and fun idea).



See if you can find SEVEN different (mirror or symmetry) arrows thru this Tetrahedron. The heart has SEVEN muscle layers in this symmetry as well. There is the famous book on Native American Wisdom SEVEN ARROWS. See the origin of Hebrew letters? [goldenmean.info/dnaring](http://goldenmean.info/dnaring)

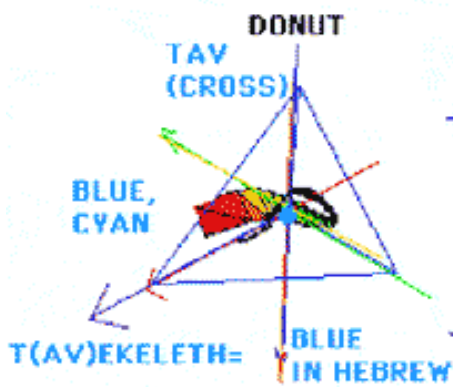


*Above: Ophanim Sigil of Truth  
Bird Tribe-Cherokee Shape of Sacred Space  
5 spins inside and 7 spins outside*

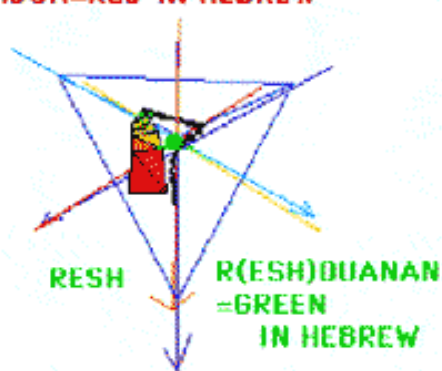
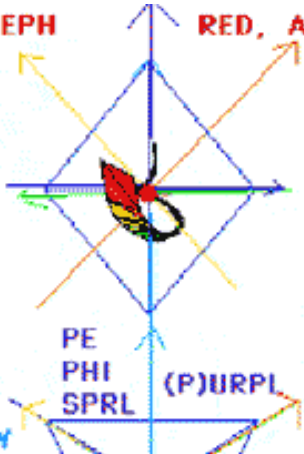
7 layers in your heart - preparing to SQUEEZE perfectly..



7 SPIN AXES OF TETRA  
ORIGIN 7 CLR MAPPED

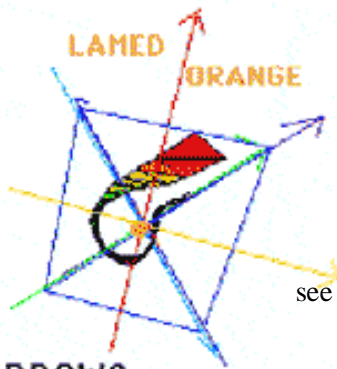


ALEPH RED, ADAMIC (HARD MAKING)  
ADOM=RED IN HEBREW

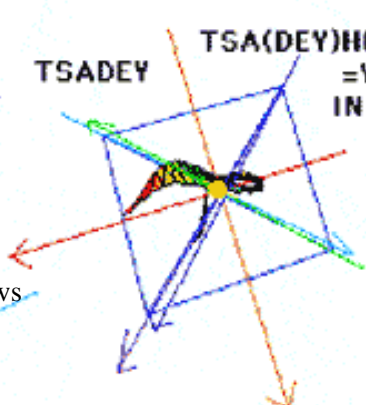


7 Arrows of the Heart (from the 7 Symmetry Arrows Thru a Tetra.. compared to the Hebrew letters for the 7 colors..)

LAMED ORANGE

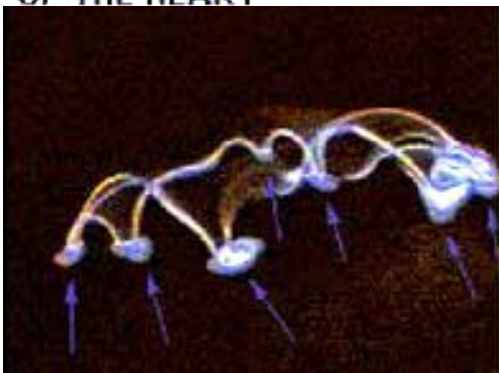


TSADEY TSA(DEY)HOB =YELLOW IN HEBREW



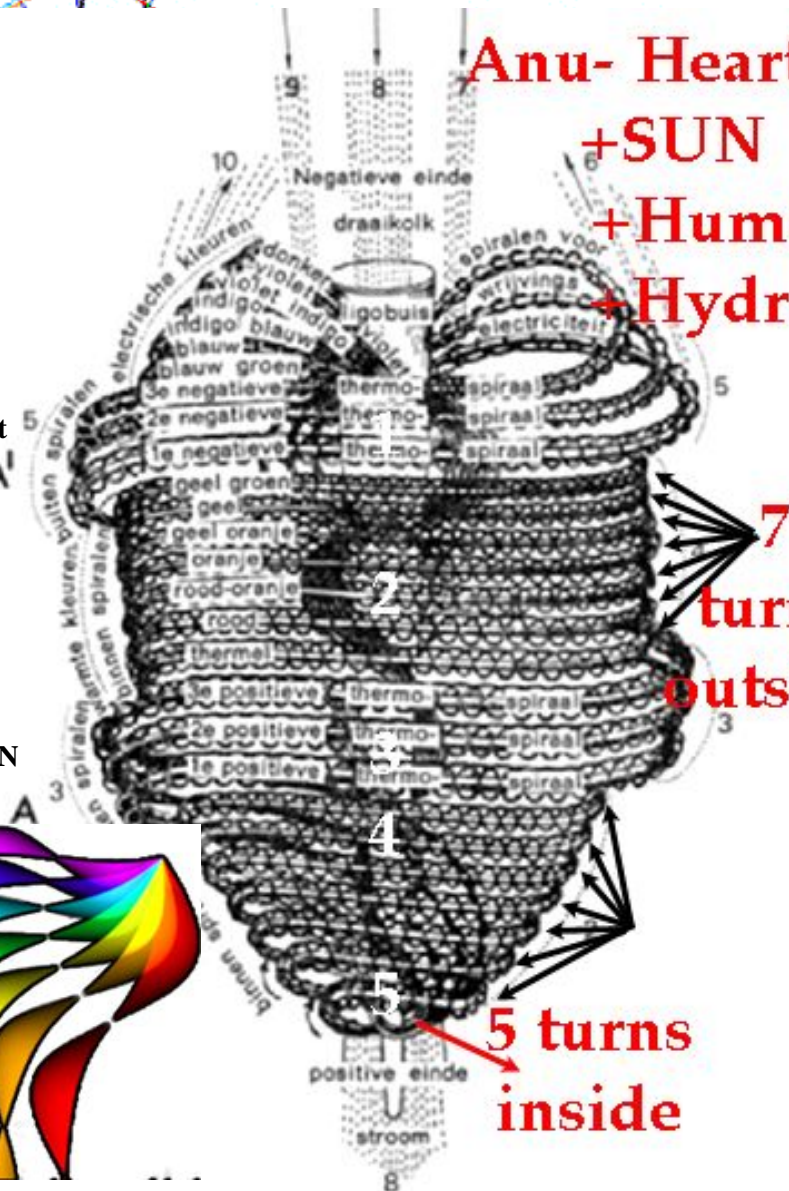
see [goldenmean.info/7arrows](http://goldenmean.info/7arrows)

7 ARROWS OF THE HEART



The PHOTON (the bubbles that light is made of) travel as donuts. When they get into a traffic jam (compression in a prism) they sort themselves in the only way they can all pass one lane.. the seven spin symmetries which all fit ONE tetrahedron (above).. this is how the TILT of the light PHOTON .. becomes the SEVEN colors of the RAINBOW!!

Anu- Heart of +SUN +Human +Hydrogen



SO - let's review the steps. You suck all the feeling waves in a room - inside your heart - by imagining PERFECT COMPRESSION. As you do this (it is called COMPASSION - which MEANS perfect Compression!) - you start the process of sorting out confusion into order. This happens because your Heart is the perfect place to GATHER WAVES into ONE - it is the perfect compressor.

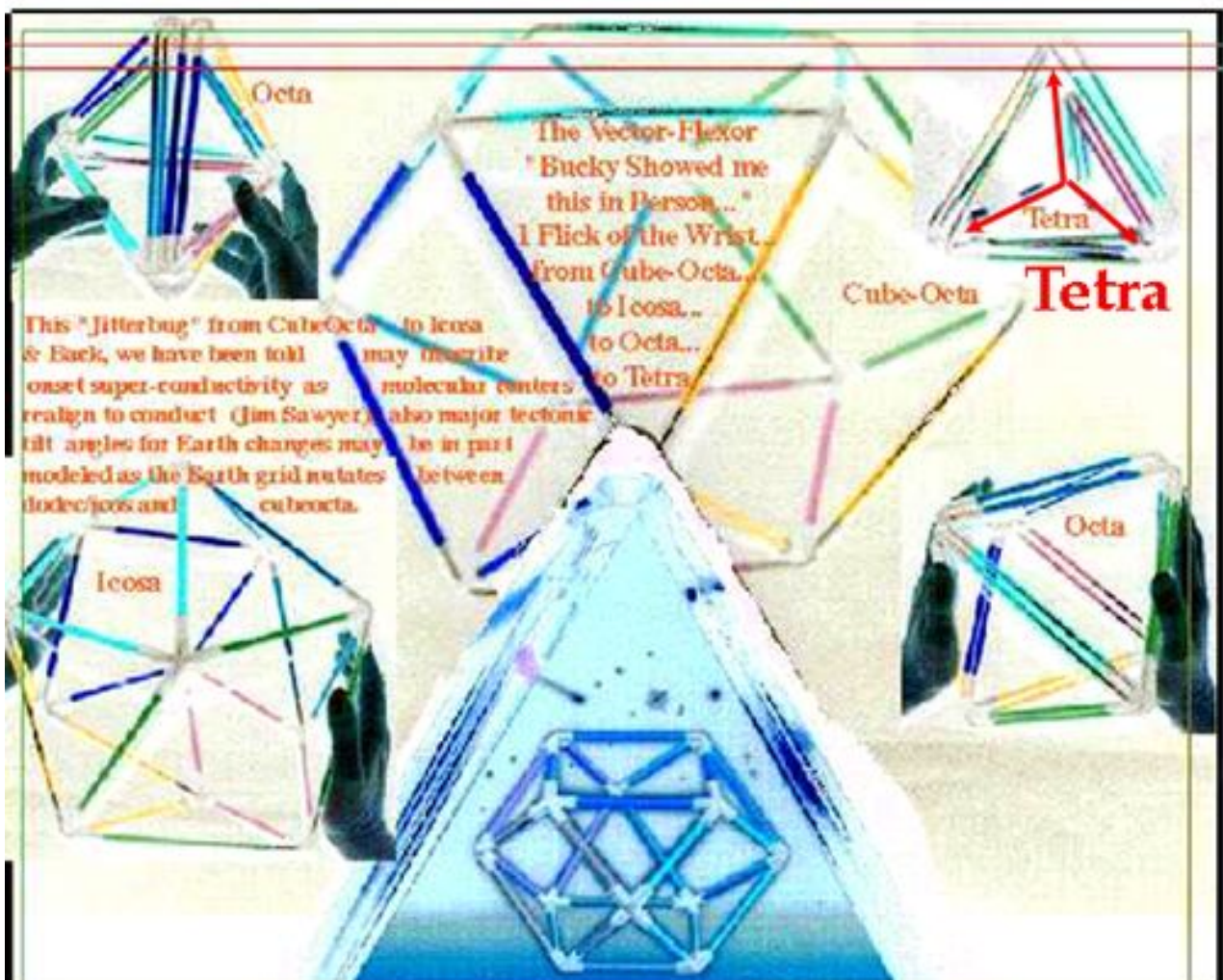
In fact - we could say - your heart is so well designed- that **YOU COULDN'T GET A BETTER SQUEEZE.** (Our joke is that this is the ad for a very good Tomato Juicer .)

The REASON your heart works so good to START THE PROCESS OF SQUEEZING - (to DIMPLE and to MAKE HEART) - is because of its design - its pattern. Your heart is put together in a way to perfectly allow excellent squeezing. The reason it works so good - is because there are basically only SEVEN ARROWS or ANGLES at which you can SQUEEZE YOUR WAY INTO ANYTHING..

Have you ever wondered why they say there are **SEVEN colors in the RAINBOW?** and why there are SEVEN (Cupids?) ARROWS thru the heart? Even have you wondered why there are so many spiritual stories about the **SEVENTH SIGN and the SEVENTH SEAL?** Well it turns out there is a simple reason in pattern or symmetry of wave to understand this.

Everything in the universe is made of waves which spin in circles. When waves spin in circles they store something we called INERTIA. This is the tendency of a spinning top to stay where it is. The neat thing is that in science - inertia is the only definition or measurement there is for creation / matter. The way scientists ("quantum mechanics") say this is - rotation is definition of both MASS (matter / stuff / everything ) and TIME! Anyway - for us to remember - spin or rotation is the source of everything that gets created. Waves in a circle - science calls mass or matter. So - in a nutshell - **if it does not go in circles (rotation) - it doesn't matter!** (because it doesn't create mass by storing this inertia - like a gyroscope or spinning top does).

So to answer the question about **why 7:** Waves always have to rotate or spin around in such a way that when they meet on the other side of the circle - they don't cancel each other out - so they don't fight. The principle which allows them to find the wave length which lets them keep spinning or rotating - without cancelling is





called SYMMETRY. (we talked about - 'all done with mirrors'). This means that one side of the spin pattern has to be a mirror image of the other side - so that when the parts of the spinning wave going around the circle - meet up - they can avoid fighting or DESTRUCTIVE interfering.  
See the pictures- previous page..

..

The process of discovering how many ways you can spin around to complete this nesting, is not just in 1 circle on a flat paper ( on a 'plane'). As the waves look for every way to make rotation around one center, they do it in ALL directions. The result is the waves discover the kind of shape around which the MOST number of spins or rotations can happen.

The result of this searching for the most SYMMETRY (the most axes or arrows of spin- which could fit in a mirror ) - is the waves find the SHAPE which has the MOST SYMMETRY..

This turns out to be the TETRA hedron. (Tetra means FOUR, Hedra means FACES - FOUR triangle faces makes a tetrahedron). This shape is the BASIS of the HEART's muscle AND the ORIGIN OF RAINBOW S.. There are SEVEN ARROW S or SEVEN AXES OF SYMMETRY thru the tetrahedron.

**See in the picture the way the seven arrows - are formed in the layers of the heart. This is YOUR best trick for squeezing into LOVE - EVERYTHING IN THE UNIVERSE!!**

(previous page pictures)

This is an example of SACRED in GEOMETRY. **Sacred means a pattern which works so well among waves - that it lasts forever.** It might seem at first a little strange to define the word sacred without religion, but if you think about it - this definition of sacred works SO well - that it actually makes religion MORE interesting. This is because - if everything is made of waves (including beautiful pictures used in religion) then understanding what makes them last forever as a pattern - helps you understand how deep and important they are. For example - **the sign of the cross you make in many religions is actually a way of moving an electric field into a pattern - (this is called WAVE GUIDE ) which lasts longer. By focusing inside - you make the field effects of charge CROSS - and this stabilizes them into a wave form that can stand - and HOLD your BLESSING!** (Your BLISSing). This kind of thinking where you connect old stories and tradition to NEW principles will begin to help you see for yourself the power of religion - in new and scientific ways. Until soon - you will be able to make all you important decisions for yourself - from the inside - from PURE principle or what is called ESSENCE.

The practice of taking responsibility inside yourself - for creation is called SELF EM-POWER-MENT. It means that **you become powerful INSIDE YOURSELF - because you understand deeply the way things work INSIDE**. This kind of power does not become mean or nasty power - because we are going to learn - that the way waves inside your heart work - (their PRINCIPLE) is that every time you squeeze - **THEY TEST FOR WHICH WAVES ARE SHARE-ABLE**. This means that only waves that can SHARE WELL - survive. It's like you were looking at your report card for your grade on how you did in your first year of kinder-garten. There you get a mark for **PLAYS WELL AND SHARES WELL WITH OTHERS**. Well in fact - when waves are properly squeezed into COMPLETE COMPRESSION - they get a GRADE on whether they share well! The ability of a wave to share space - in science is called COHERENCE. This is what our HeartTuner (heartcoherence.com) measures in your heart. Sharing or COHERENCE - determines if a wave gets to keep on going - or if it is cancelled out. Remember COHERENCE is the difference between your battery flashlight as different from A LASER. LASER light goes a long way ! Even to the moon.

The neat thing is that **if you learn to be COHERENT in your heart - then YOUR waves will go a long way. This process for a wave to become shareable in science is measured in COHERENCE. It is just like your teacher tells you when you get very confused - that YOU NEED TO GET MORE COHERENT. This is all very important because:**

**1. COHERENCE (focus and order in your inside heart waves) is a way to measure PURE INTENTION (how SHARE-ABLE you are)!**

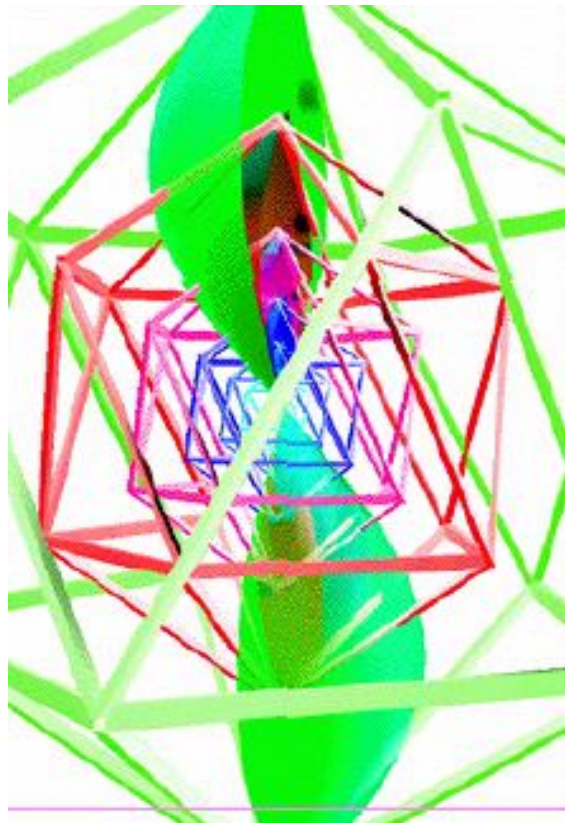
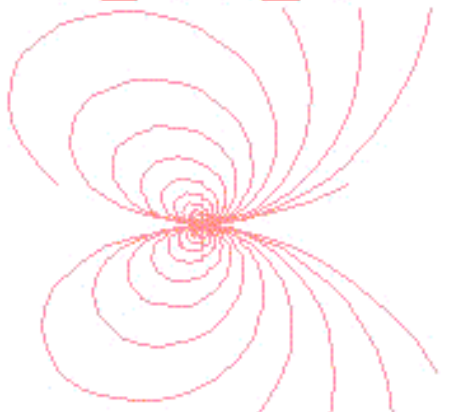
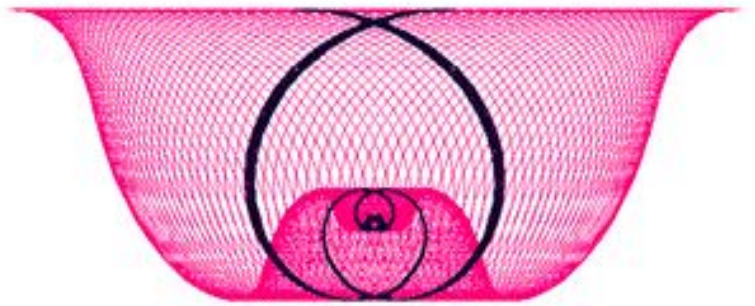
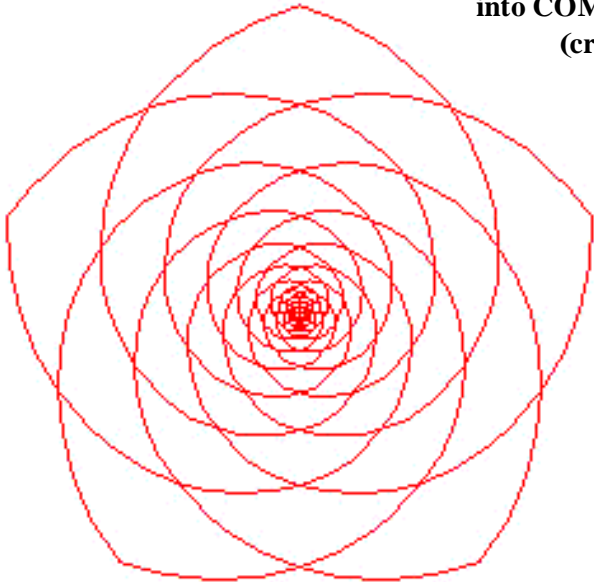
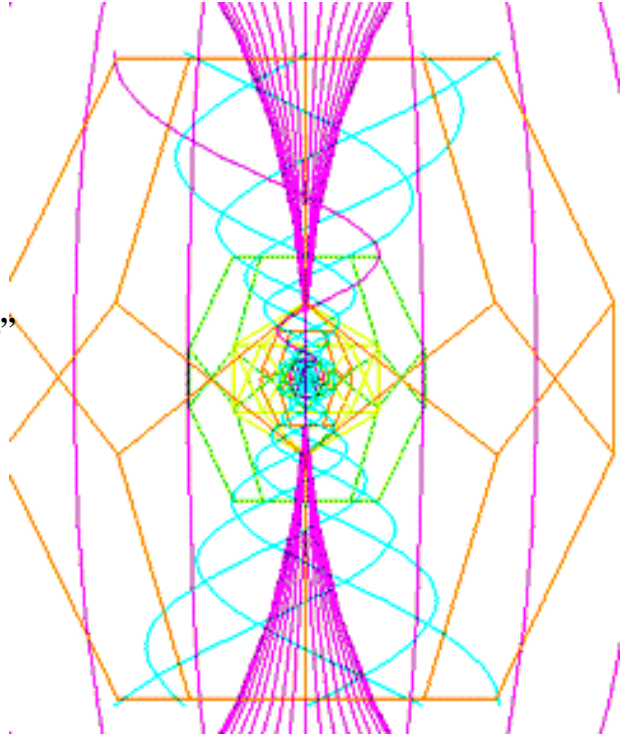
**and**

**2. COHERENCE - is the way to find out if the waves inside your heart and your blood (the waves of electrical CHARGE) are going to make it - to survive THRU death!**

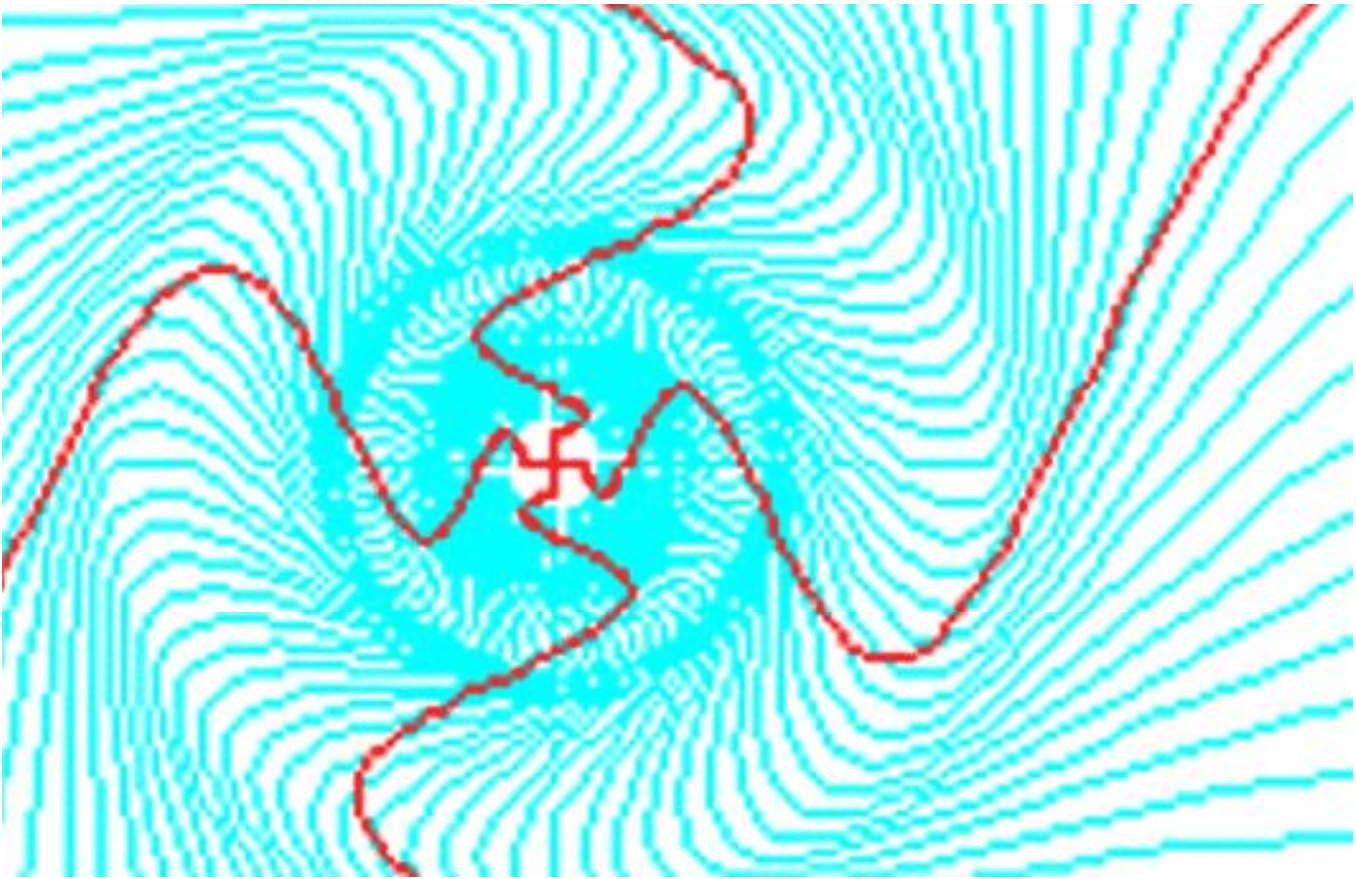
---



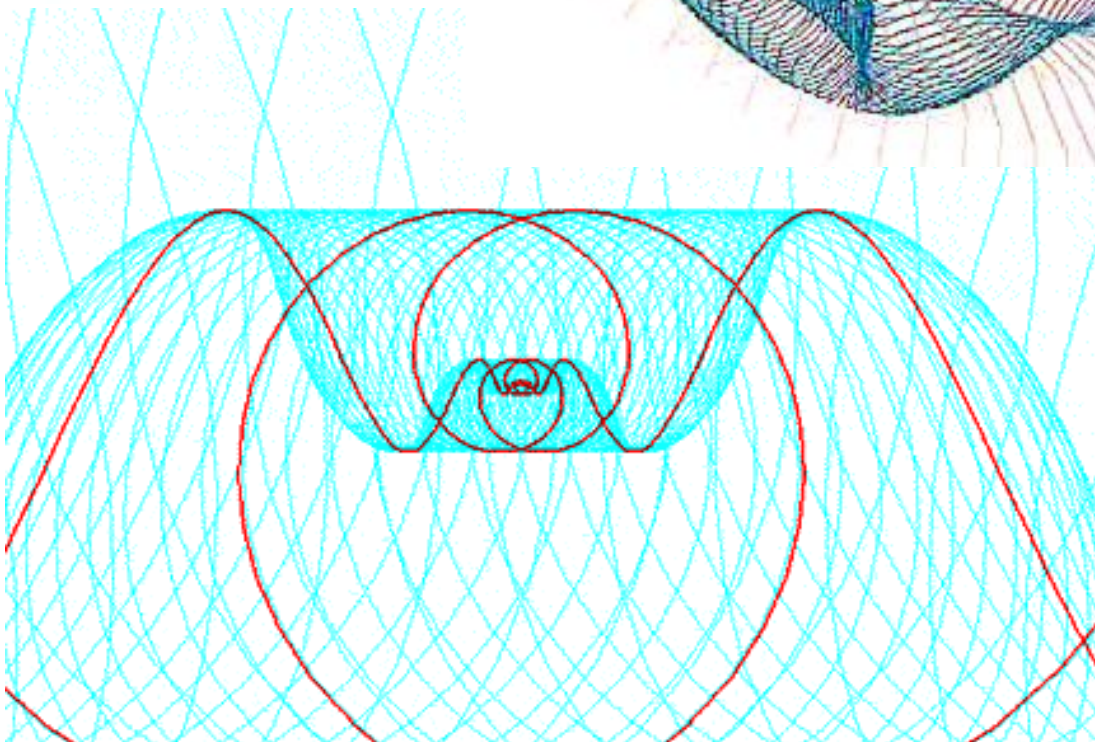
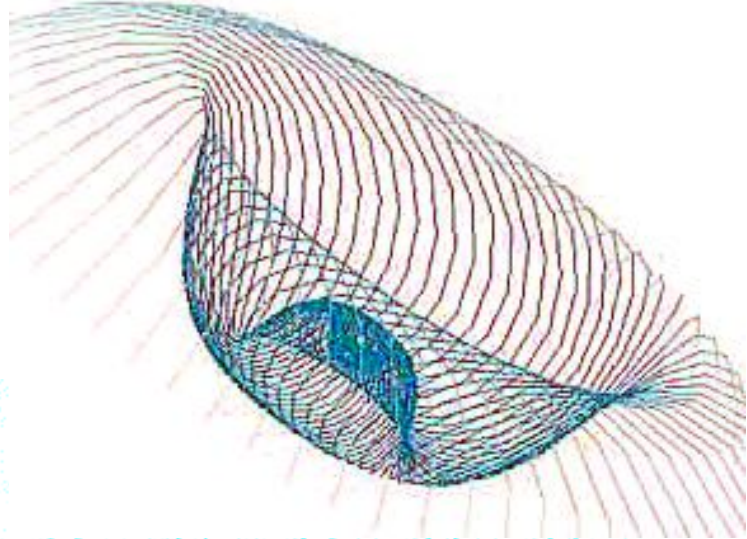
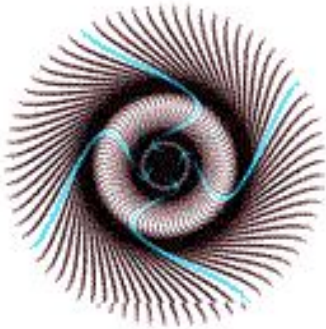
**The Origin of the  
“SIGN OF THE CROSS”  
versus  
the SWASZTIKA  
and  
the HOLY GRAIL:  
These are  
WAVE GUIDES  
(Patterns of energy)  
to steer CHARGE  
into COMPRESSION  
(creation)**







**The Swastika (a piece of the grail - compression from the Golden Spiral) was a correct guide to steer charge into compression/ creation.**





So let's talk about DYING! This could actually be a rather fun conversation. We have lots of new science about understanding what happens at DEATH. This could help give us lots of information about how to plan to survive death.

First - what does it mean to survive death? We now understand that all of your bodies memory in fact is stored as waves of this charge creating the SHAPE you call memory. For example:

1. Your AURA - your HALO - is the shape of this charge.
2. Your DNA ( the braiding intelligent worm in your blood we are going to talk about) survives dividing in the cell - because of this CHARGE shape.
3. Your LIFE FORCE - your vital energy - your CHI - is the shape of this charge. (Sometimes also called ORGONE, BARRAKAH, SHAKTIPAT etc.)- see how we measure it.

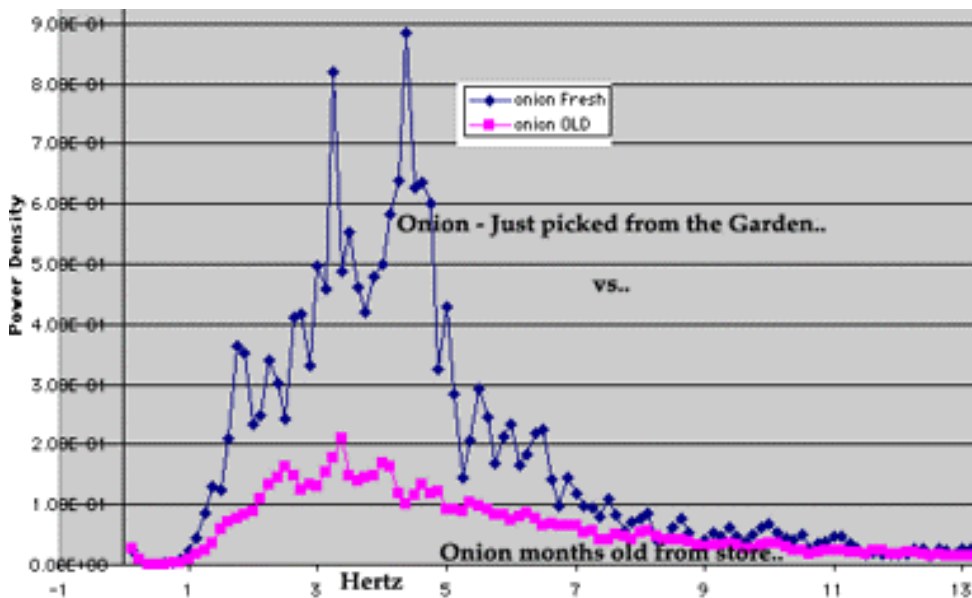


Where does the voltage come from  
Which a fresh egg creates?

Could it be a 'dielectric symmetry'  
of CHARGE Implosion?

(The egg is a non-linear dielectric  
Capacitor - knows how to CHARGE  
Itself...)

Here we do some experiments  
To measure that charge -  
The electric field created by  
FRESHNESS...  
We took a large ostrich egg,  
Cut it in half, coated the inside  
With GOLD - and used it as  
As 'spherical capacitor' / container  
And then measure the voltage generated  
In the weak field around the EGG  
(Using HeartTuner..  
We amplify and do harmonic analysis)



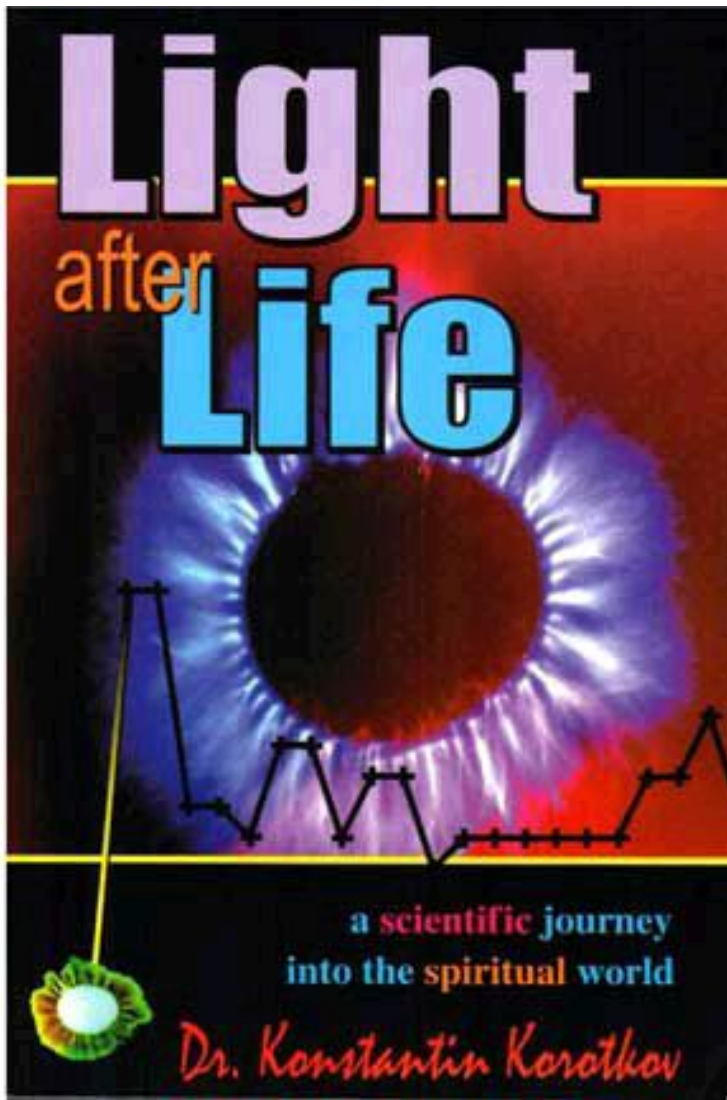
LEFT:

Amount of CHARGE (LIFE)  
Radiating from a Fresh  
Onion versus an older one..

Read more at  
[goldenmean.info/biophoton](http://goldenmean.info/biophoton)

LIFE= Ability to attract and  
self organize CHARGE.  
LIFE is measured as  
CHARGE Spreading..





On this page we show pictures of Dr. Korotkov in Russia's book: LIGHT AFTER LIFE. He **measured the amount of LIFE radiating in CHARGE off the fingertip**. He used a KIRLIAN (aura) photo to picture the charge around the finger. He made measurements of people in the hours AFTER THEY DIED. He showed that spirit flows from the body - as the "Tebetan Book of the Dead" says - at peak times after the moment of death. (see below - 10 & 36 hours and so on.).

more at- [goldenmean.info/death](http://goldenmean.info/death)

We use this to begin to study how to die well- because we now see how to radiate (spread) charge well. This also applies to how to BLISS well!

This same Professor measured the electricity of BLISS in the lab - as GOLDEN MEAN in brainwaves ( see [goldenmean.info/brainphire](http://goldenmean.info/brainphire)

The reason that memory in your body (memory in all of biology ) IS the shape of this field of CHARGE - is because it is the angle of the waves of the charge which shape the liquid as it forms into the cells (the liquid crystal ) called BIOLOGY. In other words- nothing in your body takes shape magically turning liquids in your stomach in to the beautiful shape of your body (your cells) - UNLESS this CHARGE FIELD has ORDER in it. In fact this CHARGE WAVE field is so important - that it is probably the same thing which in religion they call SPIRIT! (The word for SPIRIT comes from - SPIRAL - IT, which is PRECISELY what this charge does! - it SPIRALS - it.)

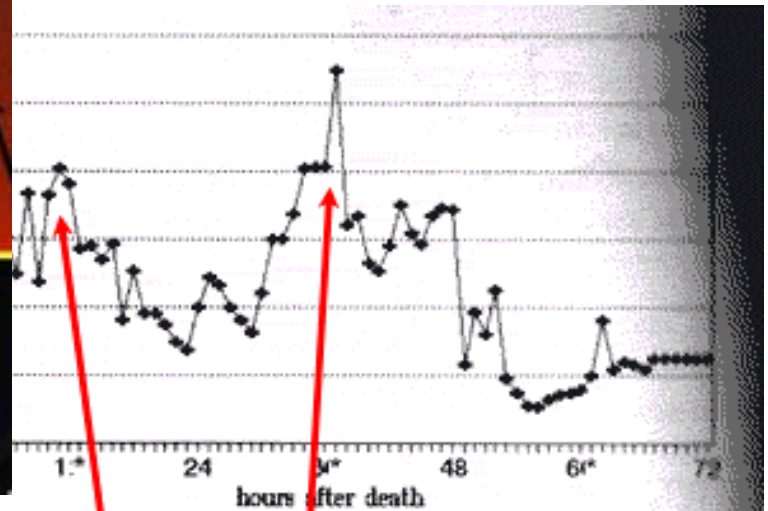


Fig. 2.5 Time dependence of Kirlian glow area of a finger for experiment N1. Vertical axis represents the area of the image; horizontal axis represents time in hours after death. Middle finger

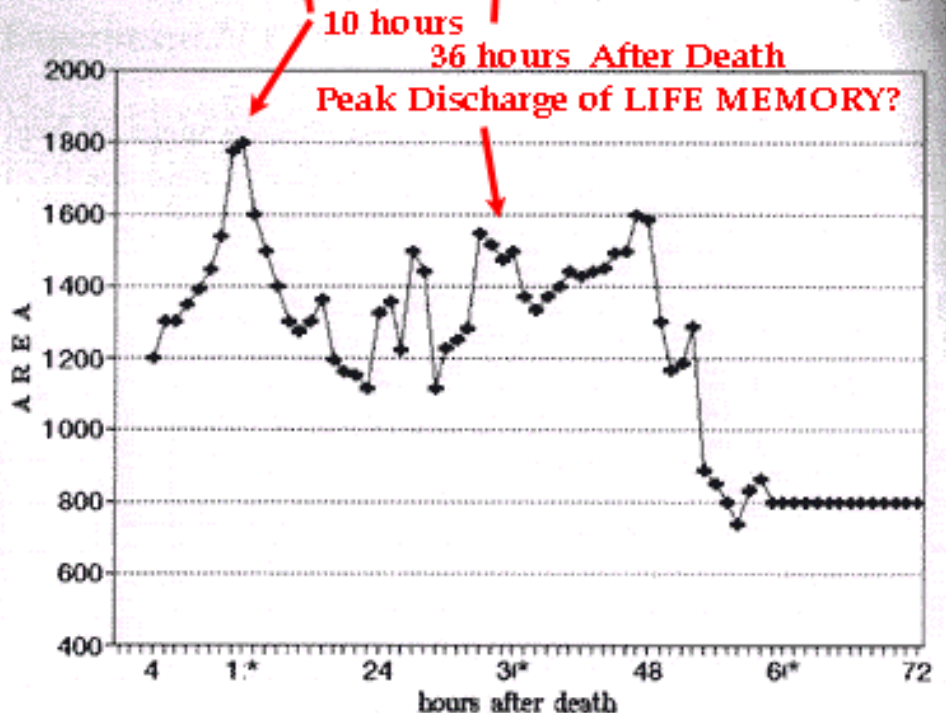


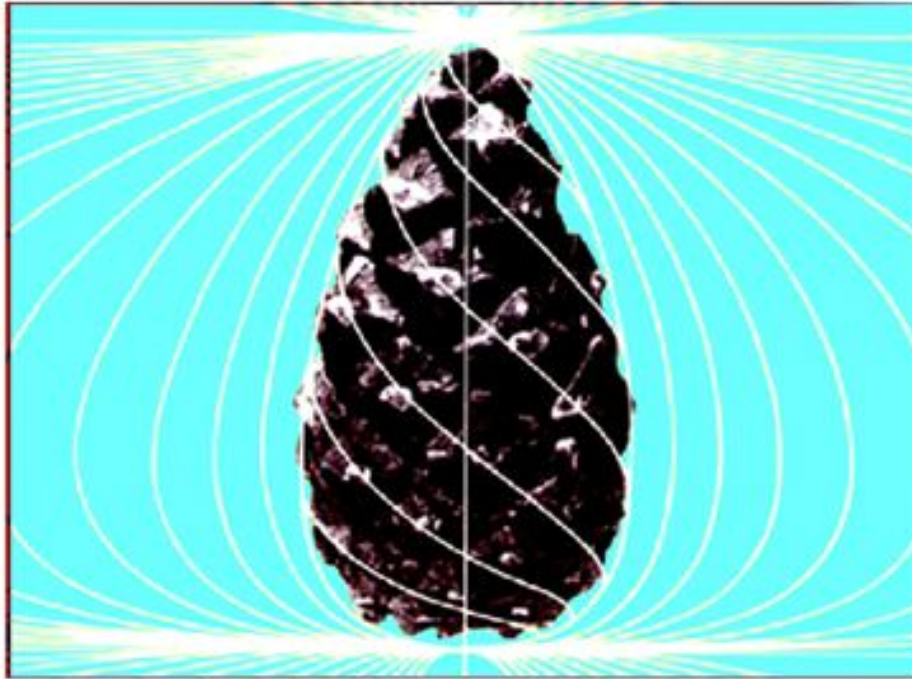
Fig. 2.6 Time dependence of Kirlian glow area of a finger for experiment N1. Vertical axis represents the area of the picture; horizontal axis represents time in hours after death. Ring finger.

Rudolf Steiner - the famous person who inspired WALDORF schools- calls **the shape of this CHARGE spirit - ETHERIC FORM-ATIVE FORCES**. The word ether - is the way science talks about the background waves of this charge which are everywhere. He calls **the ANGLE at which these fields radiate- PROJECTIVE GEOMETRY**.

**Implosion Paths for 'Charge' seen in the 'Projective Geometry'  
Around a pine cone - adapted from "Vortex of Life"**

by Lawrence Edwards..

**The principle of perfect braiding, or 'pining away' is the steering of flow to a universal meeting or fusion or implosion point.**



This is the source of the DC Voltage measurable in an egg or pine cone which quantifies life force. (most eggs generate 2-10 mv due to implosion)

**From that 'point of perfect meeting' all waves EMERGE SORTED..**

**Only 'shareable' waves which can agree and get in phase survive..**

**This illustrates how implosion becomes the principle of sorting for waves in general.**

**In physics - this principle is called 'fusion' and 'phase conjugation'.**

When this CHARGE gets compressed so that it stores INERTIA (like a spinning top ) then this same stuff (energy) is called MATTER or mass. It is important to understand the MASS or matter, and energy are made of the same thing. This is THE UNIFIED FIELD of everything. Matter or mass is just CHARGE or ENERGY that got SQUEEZED!! So learning the PRINCIPLE of how to SQUEEZE all this charge in your heart - perfectly - can truly and actually make YOU the creator! This is not just a poem or imaginary thing. This is for REAL! Real science - says the PRINCIPLE OF CREATION is the compression of CHARGE.

So - if you would like to take CHARGE of CREATION - we suggest you study the pattern in your heart - which allows you to compress waves. So that you too can enjoy creating lots of things. Especially for example if your want your DREAMS to come true. In fact - we are going to see that when you dream - especially if you dream COHERENTLY (this is called LUCID or simply CLEAR dreaming) - then you MAKE a FIELD or PATTERN of these waves of CHARGE. This was called a DREAM-SPELL in Mayan tradition. We once helped children perform the play GOD-SPELL with great music and sure enough if there was not a magical SPELL created in the room. This was an electrical 'field' (wave pattern) made of waves of CHARGE. It does not make the magic or fun of spiritual things less rich and beautiful to understand the science. It makes them MORE magical. Let's all go out and create magical DREAM SPELLS - by squeezing memories into beautiful orderly (& COHERENT) wave patterns in our hearts!



Remember in the movie "NEVER ENDING STORY" - if the little boy stopped dreaming - then the world falls apart. This is true and correct SCIENCE about waves of charge and EMOTION (dreaming and feeling) - because as we are going to learn - **dreaming and feeling with COHERENT order - is what makes the glue - the wave principle THAT HOLDS EVERYTHING TOGETHER!**

In the 'Sufi' tradition - the process of stirring lots of LOVE AND COMPASSION in a home to make everything seem to be held together in a warm connected way - is called 'THE SUBSTANCE OF WE FEELING'. (books by Doris Lessing). *Even the air feels syrupy and connected in a home where love lives.*

This picture is about the importance of DREAMING and IMAGINING. If you can properly imagine a

‘Ethereic Formative Forces’ (Steiner) are electrically described as Symmetry lines (Projective Geometry) which allow (Capacitive) CHARGE - to unpack as wave- constructively into Space.

Their self-organization by Implosive Compression - is called  
**Conscious Self-Awareness**  
 (Symmetrically -from the Vedas: Ability to Self Refer..)



The Steiner student accurately visualizes a sequence of time lapse drawings of a bulb becoming a flower.

. The room FILLS with a *love growth urge* in all present there.

Then the same student accurately visualizes that rose stepping toward wilt and death -and the feeling in the room changes dramatically.

-Learn the sequence of symmetry turns in principle to CREATE.

‘Projective Geometry’ maps constructive wave interference paths

- a good way to check where to dream or die from.

The place of power uses symmetry knowledge to gain leverage on spin.

**ROSE blossoming inside you .. you can create a sweet feeling that will fill an entire room - JUST WITH YOUR IMAGINING!**

When you are young if you spend too much time passively in front of TV or COMPUTER - without actively MAKING IMAGES CLEARLY FROM WITHIN - then you may begin to LOSE THE ABILITY TO MAKE CLEAR IMAGES IN YOUR HEAD. But if you PRACTICE VISUALIZING CLEARLY FROM WITHIN - and THEN ADD FEELING, EMOTION - YEARNING - then you can actually change the field and feeling in a room by just thinking and visualizing - so much that everyone will notice. This is important because without a clear way to shape images inside - you could lose your part in creation itself. Making the hologram wave picture of charge inside your inner vision - is your privilege to become CREATOR. Don't lose the muscles required to CREATE - by getting too passive in front of too much image making stuff (TV - COMPUTER - MOVIE) outside of your body.

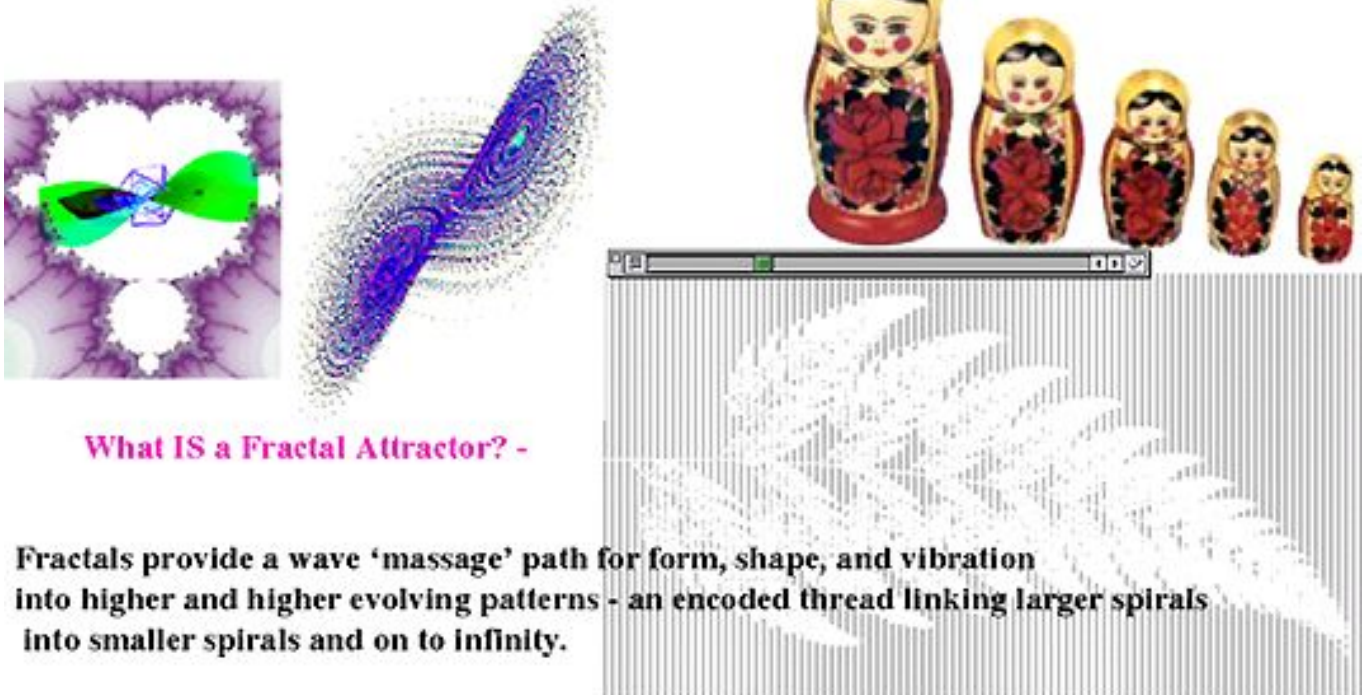
Rudolf Steiner (Waldorf schools) also called the PATTERNS - which allow this CHARGE to spread - 'PROJECTIVE GEOMETRY' This means simply a pattern or geometry that allows waves of charge to PROJECT or radiate or spread.. This is going to get very important as we learn more about successful dying. When a CHEROKEE Indian chooses where to die - he finds a little hill (sacred burial ground) which is the same in shape as the big hill behind it. The PRINCIPLE of perfect UN-PACKING for waves - is exactly this. When the wave is inside something small - that is exactly the same SHAPE as something big that contains it - then (wave) PACKING AND UNPACKING (squeezing) is orderly and without destruction. The PRINCIPLE of PERFECT SQUEEZING is actually named for this concept of SELF- SIMILARITY ...

This PRINCIPLE of how something could have the SAME SHAPE inside as outside - is called FRACTALITY.

**Get Squeezable - Get Shareable - Get Compressible - Get Fractal - Get IMMORTAL! - it's all the same!!**

This idea may be the most important thing you ever learn in your life. The reason is because since IMMOR-

## What is Self-Similarity.. Self Embedding



### What IS a Fractal Attractor? -

**Fractals provide a wave 'massage' path for form, shape, and vibration into higher and higher evolving patterns - an encoded thread linking larger spirals into smaller spirals and on to infinity.**

**Self-similarity means the inner structure has the same pattern as the outer structure.**

**Examples of natural shapes which tend to be fractal or 'self-similar':**

**a pine cone, or a fern tree, or a pineal gland - have a shape that - in 3D -**

**you could begin zooming down into center - and still ALWAYS be seeing the same thing!**

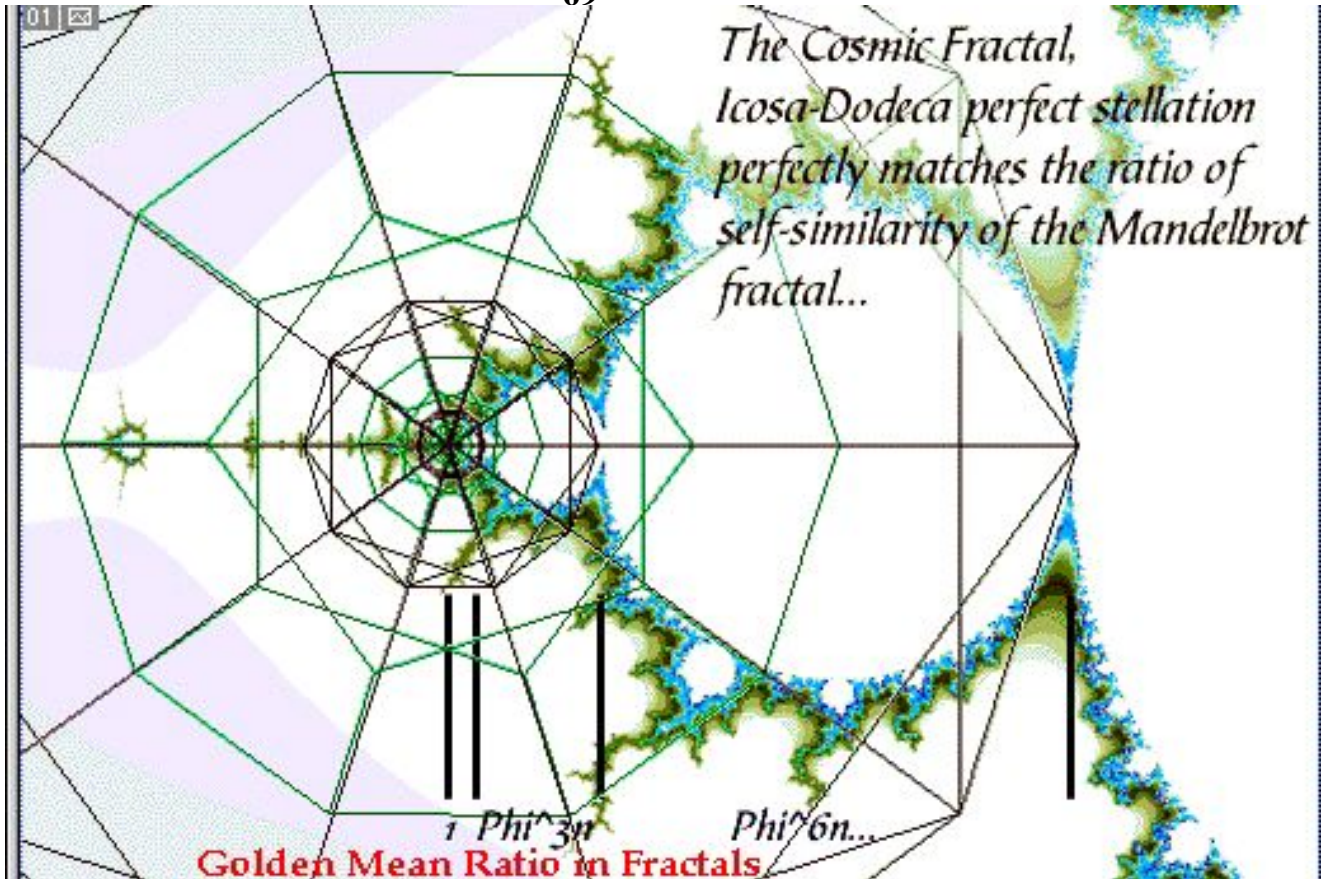
**Think of the classic Russian Dolls - where they all are shaped so that the whole family of doll - fit perfectly one inside the other. (An onion is another example of a potentially 3D fractal).**

**TALITY depends on getting SQUEEZED perfectly - it turns out that in science - THE PERFECT WAY TO GET ANYTHING SQUEEZE-ABLE - is called FRACTAL!**

So let us learn what a FRACTAL is - in fun visual terms. This will also be kool because your arithmetic or mathematics teacher will be surprised and happy that you know.

The word FRACTAL comes from a FRACTion of the ALL. In other words how could each piece of the ALL be contained in every FRACTION. Consider the idea of a HOLOGRAM. A hologram is simply a full 3 dimensional (more than just flat) picture MADE ONLY OF COHERENT LIGHT. The absolutely magical part about a hologram is you can take the waves of any piece of it -(use any part of it) - to re-create the WHOLE rest of the hologram.





I AM THAT I AM - (an old spiritual saying) might actually mean what is OUTSIDE YOU creates and points to what is INSIDE YOU. This is called the ability to look back at - or REFER to yourself. In other words - the skill to be able to REFER (or look back at) yourself - is the PRINCIPLE of being SELF AWARE. (This is called SELF-REFERENCE and it is the definition or meaning a consciousness even in the time of the ancient VEDAS). In science the ABILITY TO SELF REFER (SELF REFERENCE) becomes perfect in (you guessed already): THE GOLDEN MEAN SPIRAL.

A practical example is the time you want to wake up and become aware or "LUCID" inside a dream. The ability or skill to lucid dream is excellent practice for successful dying. In a clear or lucid or coherent dream - you return with something that you can test. You met someone or saw something which is real or testable (past - present - or future). This happens if the CHARGE wave field of your body has become COHERENT or orderly enough to steer or navigate around like a BUBBLE- even when your body itself is not present. The **capability of your body to create a COHERENT field of waves made out of CHARGE (your EMOTION)- that holds your AWARENESS - determines whether you can lucid dreaming and carry memory thru death.** And as we shall further consider - this is MEASURABLE. (heartcoherence.com )

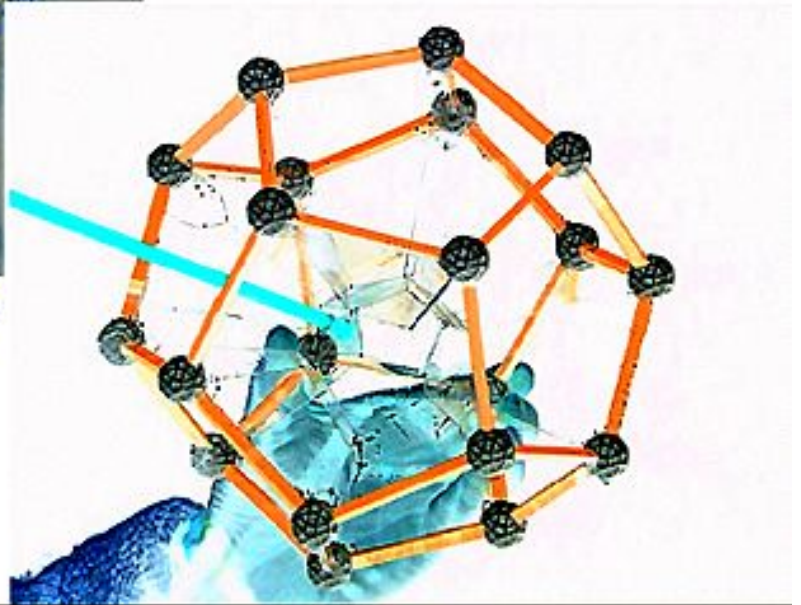
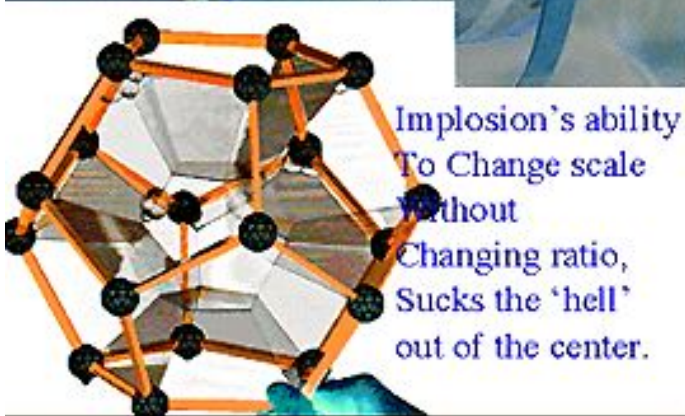
For example - Professor Korotkov in Russia, ( book: LIGHT AFTER LIFE - see goldenmean.info/death ) measured the electrical field during death. The way we do this is fun. The CHARGE waves which leave your body (your AURA or HALO ) determine how much power of LIFE you radiate. To image or picture this - we use high electrical 'VOLTAGE' (this word means high electrical pressure - because electricity flows JUST like WATER! - Voltage is PRESSURE, Amperage is AMOUNT OF FLOW).

So - put hi voltage on a picture plate - next to your body - and with wonder- you get A KIRLIAN PHOTO. This is a picture which shows a shape and color to your charge field - which spiritually is called AURA or HALO. The good Dr. K, invented a device (Gas Discharge Visualization - GDV) for doing this around your finger tip. Many thousands of Doctors use this device for testing for what part of you is sick ( diagnosis ) in countries ALL over the world.

**The fun part is clear - that the SHAPE of this field of charge - around you (in this case your fingertip) - is exactly the way to make a map of HEALTH!**



Like plant PHYlotaxes,  
Nature's Pent / PHI Ratio  
Dodeca Nest  
-DNA, Earth Grid & Zodiac..  
Have the "SCALE INVARIANCE"  
And NON-DESTRUCTIVE  
COMPRESSION  
Required to pass information  
Between worlds ..small & large.



Well, Dr.K - wrote a book about how this GLOW - your AURA - changed after DEATH! He drew a graphic to show how the amount of CHARGE or GLOW changed over an exact number of hours after death. It showed that there is an measurable electrical process of dying - and that the body RADIATES or DISTRIBUTES this electrical charge in a predictable way!

For example - as you can see by the charts (p.65)- most people radiate the most charge from their body - at peaks 10 and 36 hours after dying. This fits some spiritual books from Tibet and so on. This is important remember because we just talked about this CHARGE as exactly the MEASURE and definition of ALL BIOLOGICAL ( all your BODIES) INFORMATION. In other words- if you can get these waves of CHARGE - spreading out from your body in a pretty and organized way - AFTER DEATH - THEN - you can take your memories WITH YOU!!!

Remember this is why the wise Cherokee Indian chooses a PLACE to die ( little hill matching big hill behind - means FRACTAL) because this is the place where CHARGE can unpack and spread - without interfering! This is not - believe in life after death because you have FAITH - (not a bad thing either) this is - believe in LIFE after DEATH - because you know the PRINCIPLE! Namely- that LIFE FORCE is the amount of waves of CHARGE that you contain. AND - that the ability to hold and spread the PATTERN of that CHARGE is LIFE and is LIFE AFTER DEATH.

You saw pictures (P64) of how we measured LIFE by measuring CHARGE. More of the science information about this way to measure LIFE - applied in business - and so on - is at [goldenmean.info/biophoton](http://goldenmean.info/biophoton)  
Dr. K was even able to predict by measurement where a GHOST was most likely to show up in a room.



(The place where CHARGE is COMPRESSED). Ghosts have to live where charge compresses or they bleed. The difference between living humans and ghosts is only how much charge is compressed. The ghost is more fragile because less inertia is stored in the field effect of a ghost. The alive person is also made of compressed charge - but the amount of that inertia compressed is greater and more dense. (Same substance difference in how dense the compression).

It is also true for live people - their auras bleed in places where charge cannot compress, unfortunately most people don't know this- so they get tired in metal buildings -under artificial lights and so on - and never realize why.

This is the same way we can measure what part of a house (architecture) is sacred or **makes life** - by measuring the number of different wavelengths of charge which all arrive there at once in agreement. That is why we say: the role of mind among waves is to teach them to agree (wave agreement and coherence and pure intention are the same).

This is called - the harmonic or wave INCLUSIVE-ness - measured with something called a CAPACITOR - which feels these waves of CHARGE. You will see later - this is the correct way to measure GRAVITY. This is because GRAVITY happens when these waves of charge start packing in FRACTAL patterns (the perfect pattern for this is - you guessed it - GOLDEN MEAN ). When this happens **COMPRESSION turns in to SPEEDING UP (ACCELERATION)**. **SCIENCE - knows that GRAVITY is the same thing as SPEEDING UP (ACCELERATION)**. You can tell this is true because when an elevator speeds up - you feel more GRAVITY pressing down on you.

We are explaining to you - how electricity (CHARGE-) when compressed to become ACCELERATION (speeding up) - CREATES GRAVITY.. for several important reasons:

+ 1. It is time stubborn scientists learned why objects fall to the ground. (They don't know yet). CHARGE waves compress accelerate by GOLDEN MEAN - thru light speed. This is about as complicated as pulling the plug to make **suction** in your bath tub. (gravity is sucking in CHARGE) . Once you kids understand it - **it will help embarrass the dumb scientists to understand.** (see [goldenmean.info/thrust](http://goldenmean.info/thrust) and [goldenmean.info/einstein](http://goldenmean.info/einstein) )**(Maurice Cottell of 'Tutankhamon Prophecies' best solar physics - originally pointed out how arrogant current scientists are - trying to tell us how to live - when they don't know why a thing falls to the ground - we would add - they don't know what LIFE is!)**

and

+ 2. This is the key to BLISS - and- dying successfully! The smart worm (DNA) in your blood is designed with - you guessed it- GOLDEN MEAN - to turn compression (squeezing) in to acceleration (gravity). This is how the DNA in your blood **MAKES GRAVITY**. You are going to lose about 4 to 12 ounces at the instant you die. This is because of the INERTIA (mass) stored by the CHARGE in your blood. First get your show together and **re-arrange all your memories (your bodies CHARGE waves) to become SHARE-able. Then your blood's DNA can compress them into the perfect coherence (fractal) that turns squeezing in to speeding up (ACCELERATION)**. **This pushes the bubble of CHARGE COHERENCE around your body - at death - thru the speed of light - into a wormhole.** See the pictures here of the MAP - to what you will see when you die.

The DEATH map to where you go when you die - is called the KLUVER FORM CONSTANT. They asked lots of people who came back from NEAR DEATH EXPERIENCE - to draw a map to what they saw. Here is the map they drew. It is based on nesting each time one more arrow of SYMMETRY - in order to move into the NEXT DIMENSION!

**Death by Design: Electrical Hygiene for Successful Dying** ( [goldenmean.info/death](http://goldenmean.info/death) )

In the spirit of Dr. Korotkov's new book- 'Light After Life' - to describe how to die - in scientific terms. Picture p 65. ( 1998, Backbone Publishing, Box 562, Fair Lawn,NJ 07410 USA, [info@bpc-us.com](mailto:info@bpc-us.com) )

First: let us define successful dying (similar to defining successful lucid dreaming) in the language of science: A successful death would be one in which the essential symmetry (pattern) ingredients of biological charge were able to propagate (waves that keep radiating and SHARING) successfully and coherently - that is without serious loss of information density - through the death experience.

This would mean that the energy field of the body were able to sustain itself- without the rest of your heavy body after death. There is often if not usually, significant and measurable weight loss at the time of death ( 4-10 ounces/about 150-350 grams) . This weight loss - IS associated with the charge density which has been able to leave the body.

In Dr. Korokov's book (above) he does repeated measurements of that charge fields spreading - during the death time, by measuring the organization of the charge field using Gas Discharge Visualization (GDV). You can think of it as measuring the size of the Kirlian kind of Aura- in this case - around the fingertip.

Religious traditions may have done their best to teach us how to die, but now that a more disciplined - and therefore shareable language (SCIENCE) exists - clearly death instructions need to be expressed in those more accurate terms. (In the view of this author most of religion on this planet - has largely succeeded in becoming parasite like - in recent centuries - in their teaching of death hygiene.. and something better is urgently required).

It is particularly helpful that in the book - the good Doctor K., begins to compare the timing of the release of electrical charge from the body - as indicated by his replicated measurements- with the key times which may be indicated by such traditional - how to die instructions - as Tibetan Book of the Dead- and other religions. Note above- could there be some significance to the fact that often- at hour 10 and hour 36 (around 3 days) after death - there is a charge release peak? Could this relate to the idea of 3 days of mourning?

This is an appropriate time to point out some principles about biology and therefore it's sustainability - (immortality). **Biology exists because charge learned a way to compress into self-organization. Life exists because biology learned how to attract and self-organize electrical charge.** ( read [goldenmean.info/biophoton](http://goldenmean.info/biophoton) ).

*Fractals provide a wave 'massage' path for form, shape, and vibration into higher and higher evolving patterns - an encoded thread linking larger spirals into smaller spirals and on to infinity.*

*Self-similarity means the inner structure has the same pattern as the outer structure. Examples of natural shapes which tend to be fractal or 'self-similar': a pine cone, or a fern tree, or a pineal gland.*

*They have a shape that - in 3D - you could begin zooming down into center - and still ALWAYS be seeing the same thing! Think of the classic Russian Dolls - where they all are shaped so that the whole family of dolls - fit perfectly one inside the other.*

*An onion is another example of a potentially 3D fractal. The PERFECT 3D fractal may be the HOLY GRAIL itself - pictures on page -63 , or at [goldenmean.info/grail](http://goldenmean.info/grail) .*

**The ability to attract and self-organize electrical charge we call LIFE - exists to the extent that biological structures build and maintain self-similar or 'fractal' geometry. This is because self-similarity in the arrangement of biological oscillators - and biological dielectrics ( like to seeds on a pine cone for example) - turns compression in to acceleration.** (The solution to what stumped Einstein: Infinite Non Destructive Compression).

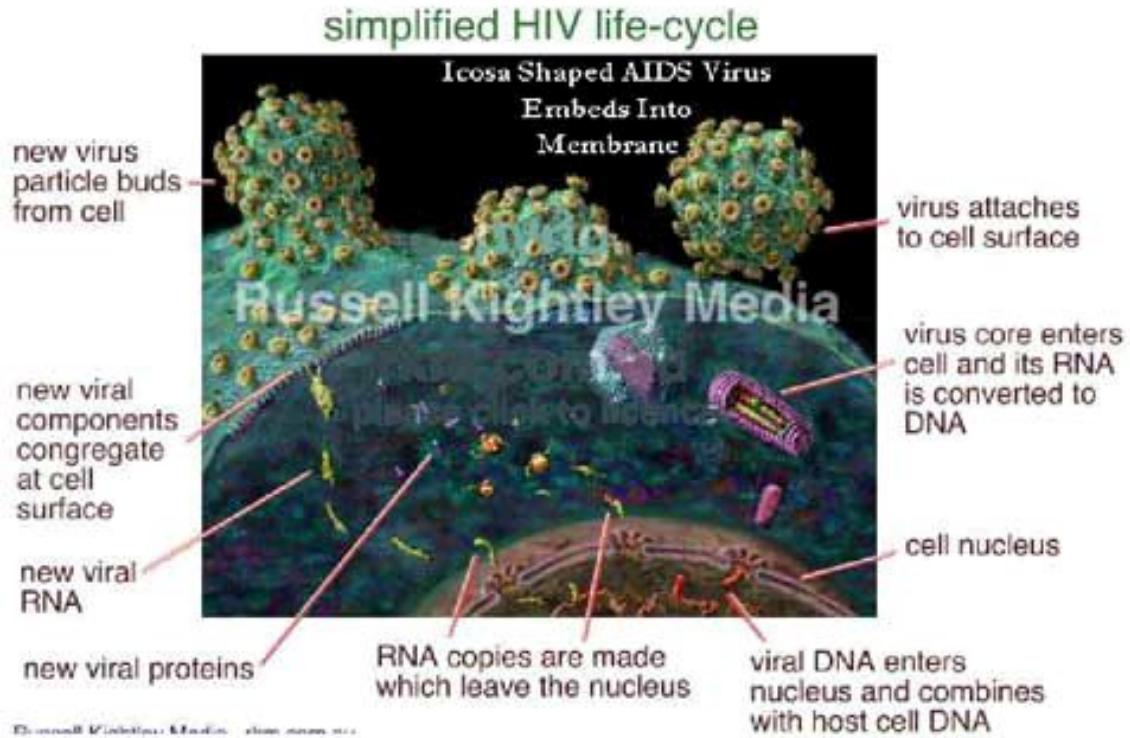
The WAY compression turns in to acceleration - is Golden Mean ratio ([phi lo tactic](http://goldenmean.info/phi) phylotaxis) based self-similar 'heterodyning' or simply constructive wave interference perfected. When that interference adds and multiplies wave velocities recursively - that acceleration resulting from compression is called IMPLOSION. **This will be proven to physics and replace Einstein's limitation the day scientists arrange capacitors into a pine cone the geometry of Golden Ratio - and discover how to make gravity. (charge acceleration).** (discussion and pictures: [goldenmean.info/phiricais](http://goldenmean.info/phiricais) ). On this day, fossil fuel and rocketry will become obsolete - but human minds will then need to take responsibility for the blood (magnetic coherence) of their gravity field - or die like Atlantis.



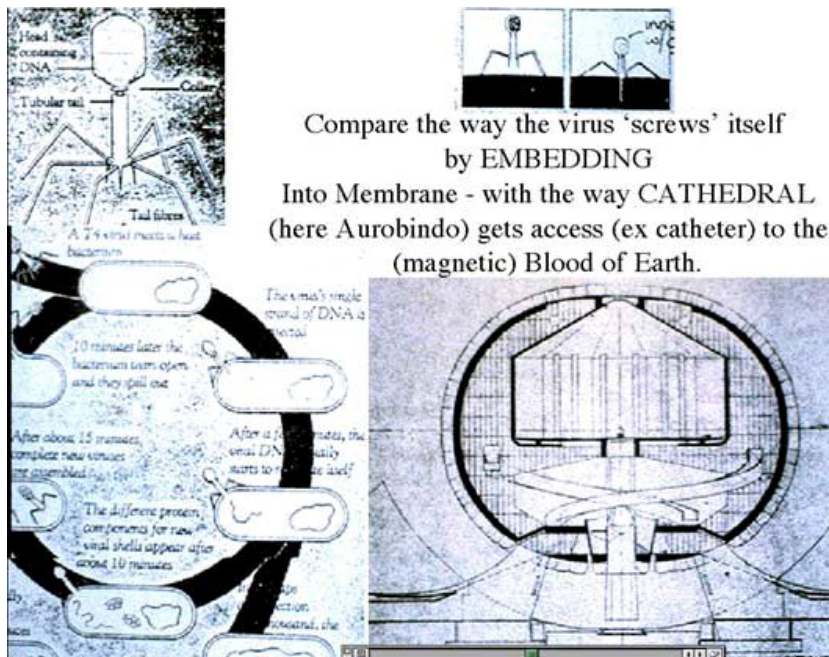
The purpose of these notes is to prepare to apply this new information about the symmetry which produces sustainability (immortality) - to practical instructions on how to die. --- Let us begin by noting **how music like is the biological symmetry which produces cell membranes and viruses.. (everything genetic - all of life)..**

**See below how ICOSAHEDRON like is the VIRUS.**

**Resonance by Shape (Morphology) is the Virus's 'Key'  
To the 'Lock' of the Membrane Wall - A 'Soap Bubble' of Waves**



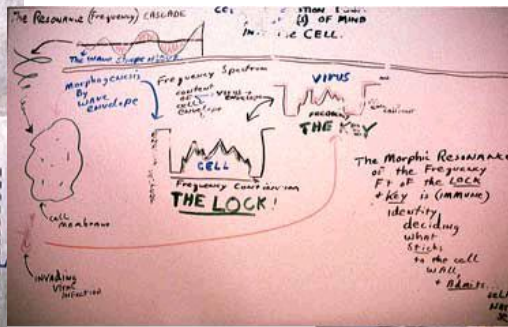
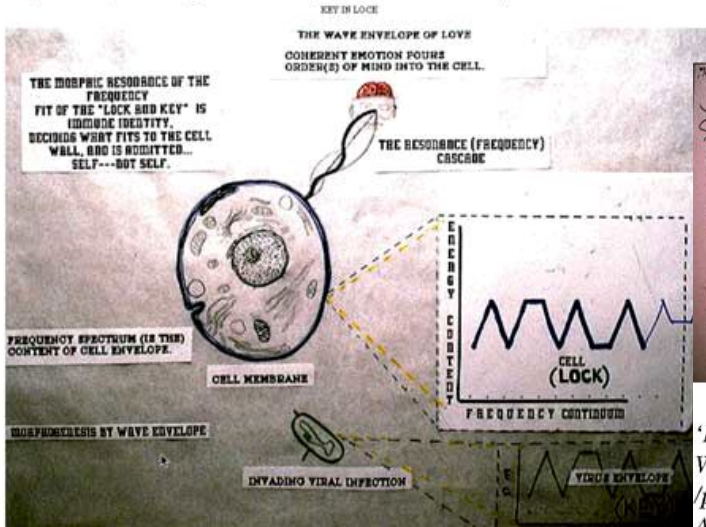
Screw like VIRUS or CATHEDRAL genetic symmetry (ex-cathedra / ex catheter / cathartic) accesses the blood of magnetism within the cell from the screwing in / EMBEDDING. Picture below.



--- So now let us see what would enable successful death to screw us in to the pine cone of pinning away - from the pineal...(goldenmean.info/pineal) Harmonics from the PINEAL next page bottom picture.



*Fitting the KEY in the LOCK: Virus DNA Harmonics are a key-Morphically testing the lock of the harmonics of the MEMBRANE.*



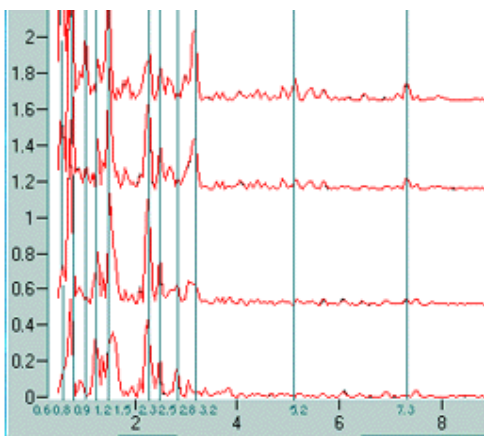
Frequency Fit ("Key in Lock")  
 Harmonic Inclusiveness  
 Of the Membrane  
 Tests the  
 Harmonic Inclusiveness  
 Of the "virus"  
 To test for Admission  
 (Source of Immune Identity)  
 -- also see "Structural Stability  
 & Morphogenesis" text: Music  
 Of the Membranes.. Also:  
 "Laws of Form"

'Popping the QWF'  
 Which Waves Lengths  
 /phase angles  
 Add spin to soap bubbles-  
 Making immune systems.



(Image credit-Right : Alex Grey) - At the moment of DEATH -Pineal gland squirts charge into pineapple perfecting compression?

Below- capacitive charge creating a cascade of (compressing?) harmonics measured with capcitive plates above the pineal - (ref: [goldenmean.info/pineal](http://goldenmean.info/pineal) and Dr. Saskia Bosman's Pineal Research web site directly: <http://www.spiralsofevolution.nl>)





The 'point' . is.. that recursion / self-similarity creates the ROSE LIKE conditions to allow compression to become acceleration. This efficient non-destructive compression of charge into acceleration is the very essence and key to the biological design for death process.

Obviously - since biology designed death to be such a part of the continuing of the biology information process - then biology TRIES to take every effort to sustain the key elements of biological information density THROUGH the death experience.

This reminds me again of the stupidity of the medical profession who describe hot flashes (ultra violet cocooning) as some kind of disease symptom during menopause. It is a good thing your DNA is not as stupid as the doctor - it KNOWS that it is fatal and mortal to be stuck below the speed of light. If your doctor knew better, he wouldn't put dying people in metal buildings. Even a rat knows that after 3 generations in a faraday cage - all data shows rats become sterile.<sup>o</sup> Whoever invented metal buildings get a little feedback: (sterility) - in this way insensitive DNA (people unwise enough to live in metal buildings ) may lose their own ability to be fertile. If we make dumb choices about living where charge dies - then we suffer. This is how biofeedback works.

The blue flash at menopause, tantra, good sex, and healthy dying is the charge coherence cocoon bubble of the body critically experimenting with the need to compress / accelerate itself thru the speed of light into sustainability (immortality). This is self-evident. Just because your average doctor or priest does not have a clue, does not mean you have to incorrectly 'screw up' your death.

In summary- we suggest - **successful dying is just like every other successful biological activity - it is the result of the successful (and non-destructive) propagation of capacitive charge.** (glossary) .

The SHAPE and faster than light projection of this charge field is the physics of astrology and the kirlian photo and the Imoto water crystallization.

These are what Steiner called **'Projective Geometry' and the 'Ethereic Formative Forces'..**

'Ethereic Formative Forces' (Steiner) are electrically described as Symmetry lines (Projective Geometry) which allow (Capacitive) CHARGE - to unpack as wave- constructively into Space.

Their self-organization by Implosive Compression - is called - Conscious Self-Awareness (Symmetrically -from the Vedas: Ability to Self Refer..)

**Remember our Steiner student accurately visualizes a sequence of time lapse drawings of a bulb becoming a flower. (picture on P.67) The room FILLS with a love growth urge in all present there.**

**Then the same student accurately visualizes that rose stepping toward wilt and death**

- and the feeling in the room changes dramatically.

- These inner images are the sequence of symmetry turns necessary to

**CREATE. This 'Projective Geometry' is a constructive wave interference path. This is a good way to check where the useful place to be when you need to dream or to die coherently.**

**The place of power uses symmetry knowledge to gain leverage/ power.**

The SHAPE of this field is what is imaged in Gas Discharge Visualization, and it is the shape of the way biological liquids crystallize into cells and life. This SHAPE of the field of charge - is what we measure when we measure life force .. by measuring the harmonics of the capacitive field of that charge... (link- [goldenmean.info/biophoton](http://goldenmean.info/biophoton)):

(Right: Life Force measured by harmonic analysis of the charge field around a fresh versus old egg.)



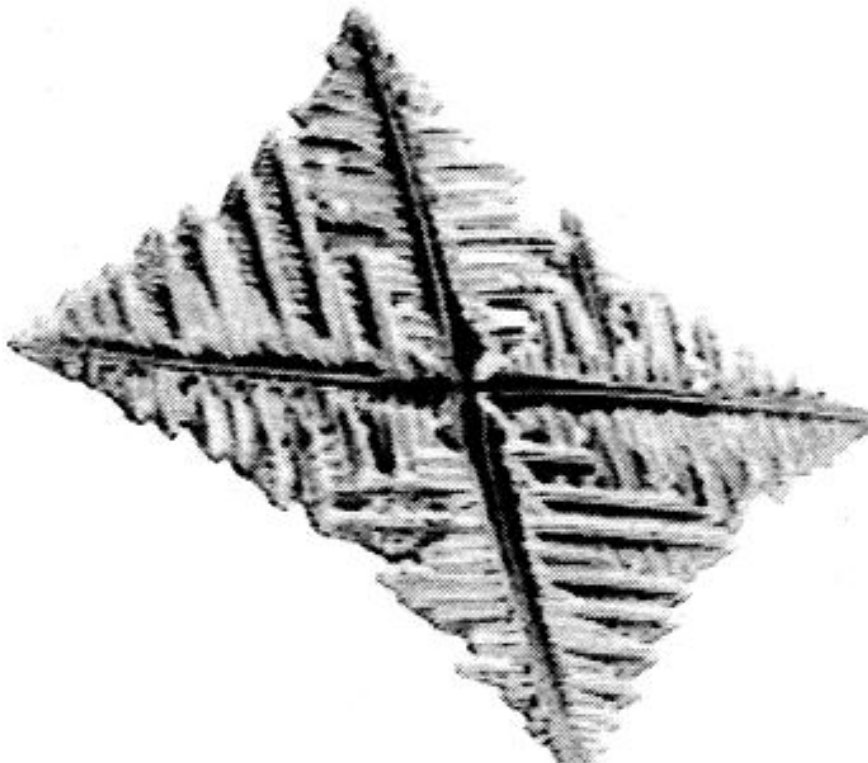
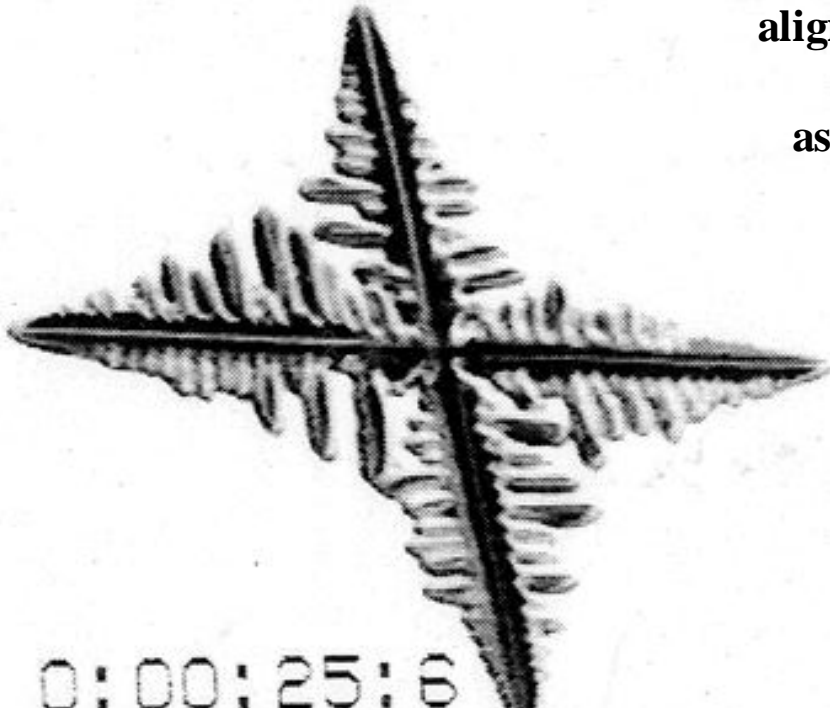
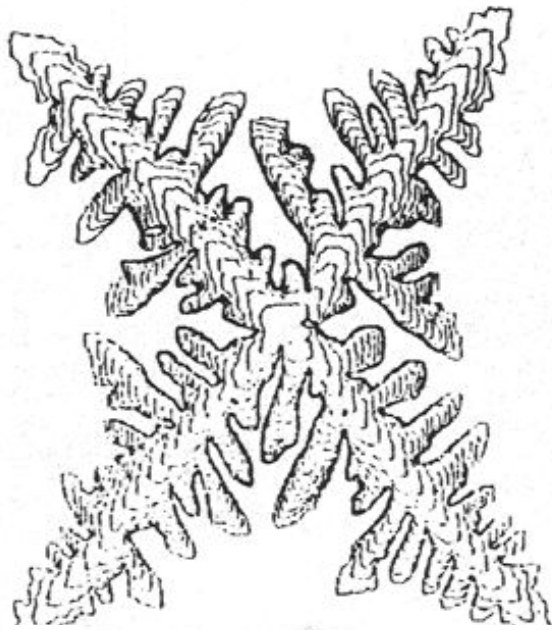
**How the Geometry of a  
COHERENT Electrical Field of  
Propagating CHARGE**

**(Measureable Capacitively)**

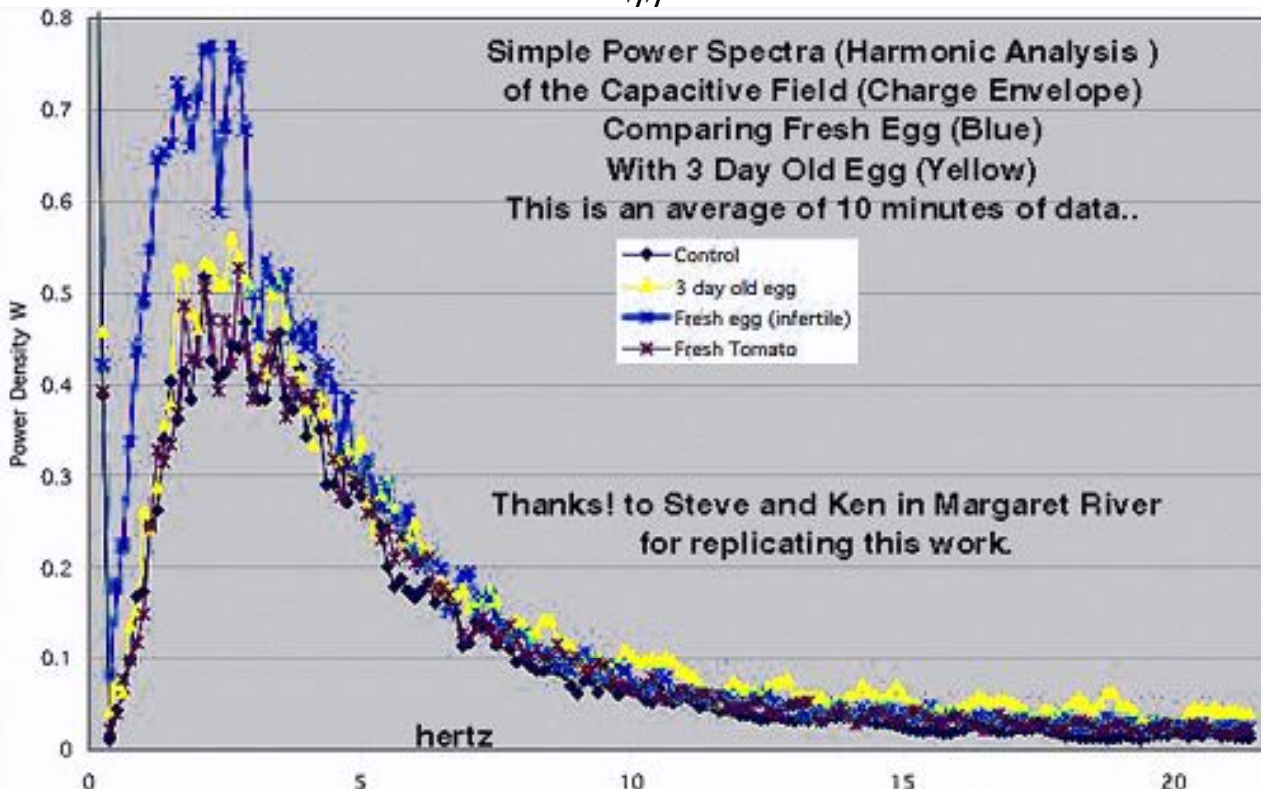
**Is the choreographer (arranger) for  
GROWTH and LIFE.**

**Peaceful growing water  
crystallizing into ice records the  
angle to major planet and star  
alignment - because the angle of the  
radiating CHARGE field IS  
astrology - AND what aligns the  
liquid to become crystal.**

**Below: Emoto example**

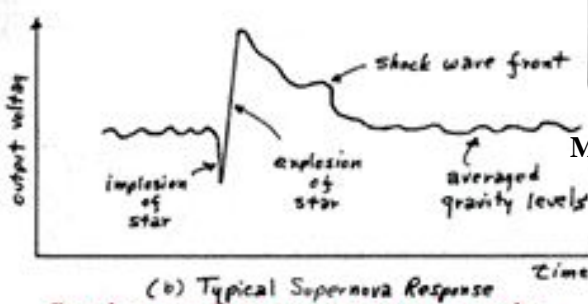
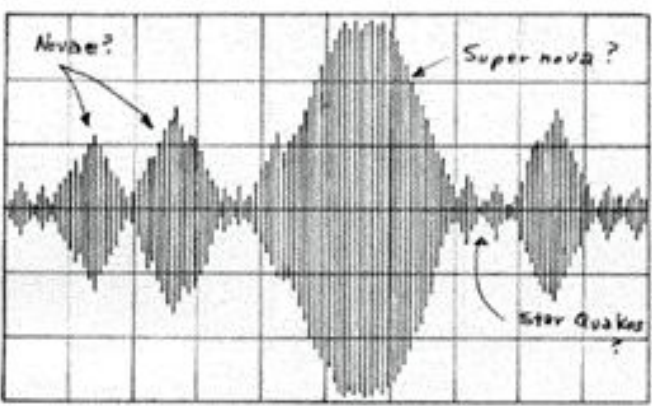
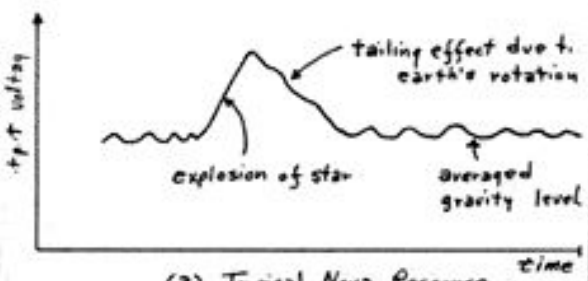






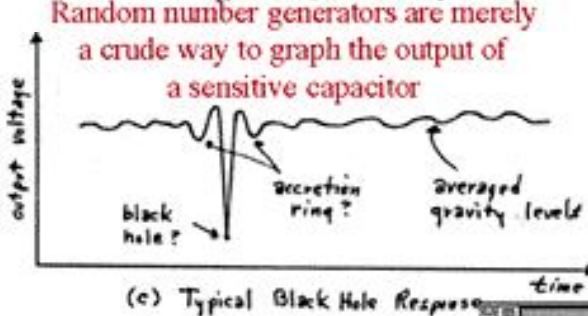
Above: see a capacitor measure which EGG is fresh by which one has CHARGE. LIFE is a field moving across a sensitive (biological?) capacitor).

Below: - the simple output of a capacitor sensing only the gravity field - proves - charge moves faster than light , the gravity is charge accelerating. See how a simple capacitor -measuring “spirit” can see star events happen faster than telescopes - even faster than light!

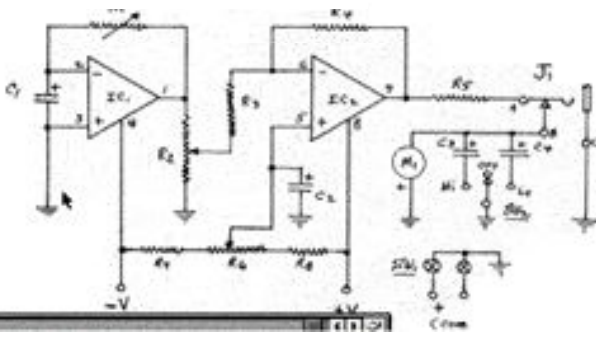


Hodowanec / Ramsey  
Measuring Stellar Gravity Events  
With Capacitors  
Replaces Telescopes  
(Faster than light response)

Vert 0.5V/cm  
Horizontal 20m/cm  
5 Ring 550 cps



Random number generators are merely a crude way to graph the output of a sensitive capacitor



The hero's in the movie "Flatliners" discover some requirements for successful dying. They were medical doctors testing how long they could remain medically dead. They found that it was necessary to re-arrange your memories such that they were maximally SHAREABLE. This meant that anyone you had hurt, you went to fix.

I suggest that as this article progresses, we attempt to discover the symmetry of the SHAREABLE in DNA and cells, in direct relation to the PSYCHOLOGY of what is shareable. The essential message is that progressing in to the symmetry of what IS shareable - is the same as progressing in to the symmetry of what CAN BE COMPRESSED. The reason for this is that inside (self-similar) compression lies the secret to effective propagation - (becoming shareable). That secret lies in turning compression in to acceleration. (Phi Recursion Induced Charge Acceleration Implosion Solution / PhiRICAIS - below) Because acceleration of charge is what makes it propagate (become shareable). This is more than poetry. This is the physics of how charge in DNA survives death. When your feelings are able to distribute to all - then DNA has found a way to do the task of holy communion. Make charge waves able to infinitely propagate. Hurting someone interferes destructively with (the symmetry of) this ability for the charge pattern in you to propagate. Learning to locate the shareable - enables immortality - because it attracts charge propagation.

*Doc says- '2 weeks to live'; You urgently begin sorting for what is shareable in your life - if you do a good job and begin to re-live only what is pure principle (shareable) you tingle with attracted charge so much, that you never die. Death was invented by biology to gently teach us to stop storing what is NOT shareable (able to compress and distribute). (Immortality section begins next chapter)*  
*Learn to recognize pure essence principle in your life, and you become immortal.*

**Arriving at the symmetry of the shareable (perfect acceleration into more infinite propagation) requires exactly the symmetry of the rose.** (pictures on Page 43) ([goldenmean.info/phiricaais](http://goldenmean.info/phiricaais)) -

Another example of successful death by successful compression: notice the Cherokee burial ground. (In our community in Waynesville, North Carolina was an example). **The place the wise one goes to die, is on the little hill which is fractal or self similar to the SHAPE of the larger mountain in the distance. From this place 'where perspective is consumed', the shape of charge memory at death - can better unpack non-destructively in to it's larger environment. If the fractal landscape is the place to die - it is also the place to live. Remember - during bliss / like during death - you electrically attract charge into yourself - as such an increasing rate - that only if your environment electrical is fractal (looks like a rose magnetically) - is your bliss / death sustainable.** (You will find that doing bliss in a metal building with lots of electrosmog is painful and not possible).

Another similar example: in "Magdalen Mystery" by Kent, the nubian copper blue blood magda 'black madonna' after death whispers instructions for decades into the likes of Templar Bernard of Clairveaux, to build the Gothic Cathedrals into a huge star map. Then her 'tantric' swoon can use the landscape as a fractal projective MAGnetic lens into those stars.

In "I Remember Union", - another book on the life of Magdalen - Jeshua spends many years preparing to die - ultimately using the Grail star map of South France. There was a recursive wrapping like swaddling clothes for a babe to reenter the womb cocoon of matrix matter charge. Many layers of living cloth folded packed like a rose around the body preparing for the death swoon. **Dying is preparing to enter perfect unpacking of your inner charge - from the totally compressed seed of implosion.**

When the "Maid of the Mist" fell in to Niagara Falls, she entered a highly charged environment cocoon, offering a certain kind of immortality.

Dr. Korotkov even notes in his book where it is most likely to encounter the ghost spirit entity of the discarnate - in the near surround of the dead body. If there was some attention to providing a fractal charge compression paramagnetic labyrinth - the dead ghost might have a place to go (compress / accelerate). In Sumerian - this was called - to "Raise a SHEM", which is to raise "AN ALTAR UNTO THE LORD", which is to raise a capacitive fractal rose like charge envelope in which to 'flame up' the local charge magnetics. Examples would include - the array of dolmen capacitors used by Enki - to set up the local field effect called 'Garden of Edin' which

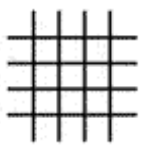


prevented cellular aging. This was considered essential mining equipment by the interventionist Gold Powder addicted Draco ancestored Annunaki. If you would like more on the story of our Dragon ancestors (Sun God versus 'Nephilim') ancestor Annunaki; see [goldenmean.info/enki](http://goldenmean.info/enki) for the 'RETURN OF ENKI'.

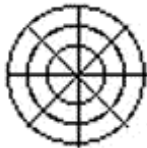
What was left was a big astral feeding ground for those who did NOT learn how to die properly. Preparing the environment and your blood for death is essential to getting immortal. It may seem strange to think about preparing to die if you are still young - BUT as we see the fun things you can really do to get immortal - it is NECESSARY to start when you are young! (See High Genes- Hygiene actions to do at the end of this book).

A map for **dying properly**. (Compress well or die poorly..)

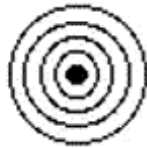
The famous Dr. Heinrich 'Kluver' interviews several hundred near death experiencers to have them draw the pattern of space they saw during dying. There was amazing similarity in the sequence of drawing patterns returning successful veterans of the death process - would record and remember. Clearly it IS possible to make a symmetry map to navigate death / from the original: 'Geometry of Eternality' at [goldenmean.info/eternal/eterna.htm](http://goldenmean.info/eternal/eterna.htm)



Lattice or Grid



CobWeb



Tunnel



Spiral

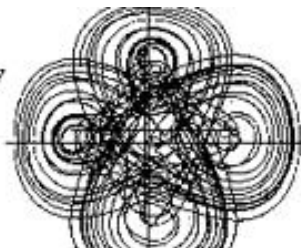
**NESTING OF ARROWS OF SPIN** (mirror 'symmetry axes') - rotation upon rotation - braid upon braid - is exactly the principle revealed in the drawings made by those who remembered dying.

## Lattice, CobWeb, Tunnel, Spiral Heinrich "Kluver" Form Constants

One vortex pair rotated into a cube. Then the cube rotates ('ratchets') into a dodec.. then the dodec rotates (rachets) down a slink helix like DNA, .. then the helix twists into what looks like THE NEXT BIGGER VORTEX PAIR.. and so on, and so on... Thus moving into the next dimension - is to move in to the next axis of symmetry (superposed spin).

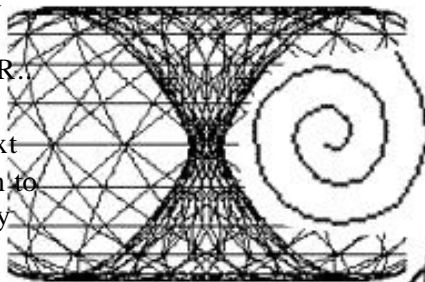
**What enables a smaller spin pattern to be rotated into the center of a new higher axis of symmetry nested (or superposed)- IS Successful COMPRESSION.**

The Wheel of Symmetry is What You Will See.. When You Die.. Informed Focus Can Climb This Ladder.



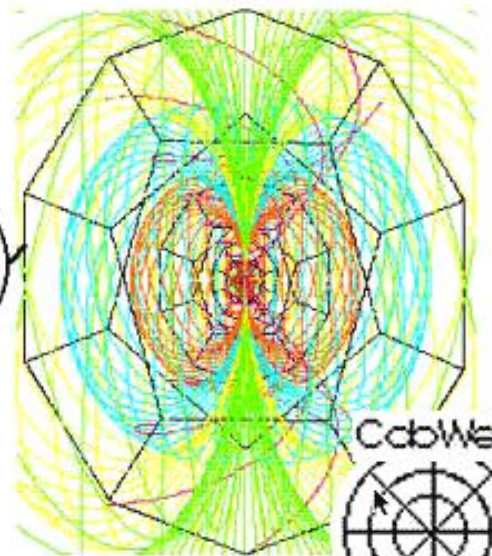
Lattice or Grid

Bilateral



Spiral

This wheel of life (self-awareness) keeps growing layers



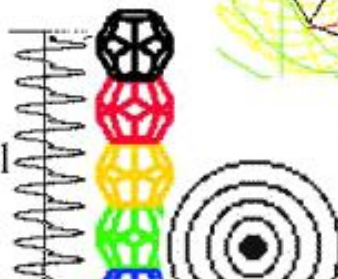
CobWeb

Rotational



Tunnel

Helical



And that this repeated (recursive) process of resolving compression into fractal perfect compression - eventually turns compression IN to acceleration (implosion). This is exactly what **DNA - as a holy communion device - to fuse CHARGE in biology** - was designed to do. And further - that **death is this symmetry test for ORDER OR COHERENCE in the field of DNA. How does DNA braiding get ordered: you guessed it - the CHARGE from BLISS!** (see exercises at the end)

Holy communion was a originally a wafer of white golde power - whose fusion - compression communion chemistry we are going to talk about - as we discuss the Sumerian origins of Adam and Eve.

What is needed is to provide the death process with the charge envelope required to facilitate this process of still point (implosive) acceleration compression.

There are geomantic (means Feng Shui or land grid magnetics) , paramagnetic, diet, clothing, dance, and even astrologic ways to do this.

Designing the sequence of hygiene instructions for successful dying begins with these principles - taken into the practical. That is what this book is for.

**Walk into the [grail](#) and you enter the fractal / the compressible. - then you do not die.**

Related: [goldenmean.info/fusion](http://goldenmean.info/fusion) , [goldenmean.info/collapse](http://goldenmean.info/collapse)  
[goldenmean.info/scaleinvariant](http://goldenmean.info/scaleinvariant)

Practical Hygiene for Successful Dying is also covered in the Course Curriculum: [goldenmean.info/course](http://goldenmean.info/course) - (times and places and course detail) upcoming in cities around the world..

### **The secret of the KA in Mer-KA-bah - and the RA in ab-RA-ham**

-----  
 In Egypt this bubble of CHARGE in which you travel (at death or in dream) is called your KA. ( as in Mer-KA-ba). When all this works good - then your memory survives dying or lucid dreaming.

This is going to turn in to a plan - a strategy - a principle - a design - to help you die successful. We call a plan for how to create LIFE immortal - HYGIENE.

But first let us look at some pictures that explain how you bloods DNA (intelligent shape- shifting worm inside) - was designed in the PATTERN of - you guessed it- GOLDEN MEAN.

You see- having this design in your blood is the important WAVE GUIDE for getting you bodies CHARGE (all your memory) ACCELERATED thru the speed of LIGHT - in order to remember thru dying. You see your blood (unlike most un-spiritual Doctors) - is HIGHLY aware that it is FATAL - (mortal) to be stuck below the speed of LIGHT! This is because it is not SUSTAIN-able to be caught below the speed of light. Remember - sustainable- for waves- is our definition - our meaning- for the word SACRED.

Also what is really KOOL is that **when you heart makes the music of love (the harmonics in your heart beat / Electro Cardio Gram / EKG) you can measure the effect of this COHERENCE on your blood's DNA!** See picture Page 35- bottom.

This means- that **the feeling of your heart that learns to SING COHERENTLY -- is actually what is BRAIDING or steering the parts of your DNA into its nesting - to PROGRAM or inform it. COHERENT Emotion (measurable: [heartcoherence.com](http://heartcoherence.com) ) is the control of your blood's DNA!**

So part of getting immortal - is getting your blood boiling up with the spinning or braiding of your heart learning to sing! This is the beginning of the SCIENCE to understand why your DNA starts falling apart - and you lose IMMORTALITY - IF YOU DO NOT GET - BLISS - ECSTASY- ENLIGHTENMENT. And it DOES begin with PASSION. Passion is a name for when you choose to FEEL something VERY STRONGLY. Sadly, in most modern cultures it has become taboo or not accepted to express major PASSION in public. For example, in CHINA and JAPAN it appears that most of the muscles that allow really big smiling and face glowing - have disappeared from the face. This may be from lack of use. If a country prevents their children from having PASSION and BLISS and ECSTASY - they are going to lose their IMMUNE SYSTEM (this means - the cells lose HEALTH)! The science is that you get HEALTH (IMMUNE SYSTEM) only if you can ATTRACT this CHARGE.



**The Heart Sounds, Long Waves..  
but Orderly, when Emotion is  
Coherent**

**Short  
Waves  
make the  
cell tick  
(U/V)**

**Ratio is the Heart's key,  
to the cell wall.**

*E-motion is the E-nergy motion CASCADING between frequencies, long waves to short. These send instructions from the heart and gland sonics directly into the cells. The geometry of ratio reaches into this cascade - a 'heterodyne' beat note path - which CRACKS THE WHIP. The musical science of COHERENT EMOTION - creates these ratios. See how you measure CONCEPTUAL versus EMPATHIC emotion on HeartTuner. Empathic or touchy feely emotions create GOLDEN MEAN - .618 Lo PHI and love..*

Here are some pictures that show how your the cells in your body are like soap bubbles. You add the spin of charge - and they don't pop. (soap bubble pics next page). This adding of spin to soap bubbles - is how the CHARGE of bliss adds spin and life to your cells! We think that diseases like AIDS in Africa - loss of IMMUNE SYSTEM - spread faster when the tribes forgot how to BLISS DANCE!

**The SPIRAL EMBEDDING Nature of emotion- to charge up cells: DID AIDS SPREAD in Africa largely AFTER the skill to BLISS DANCE was Forgotten?**

**Cell membranes  
lost charge- de-  
pleting Health  
(Immunity) -**

**also see SELF  
EMPOWERING  
AIDS AP-  
PROACHES:**

**[http://  
healthempowered.  
ipagine.com](http://healthempowered.ipagine.com)**





# Fitting the KEY in the LOCK: Virus DNA Harmonics are a key-Morphically testing the lock of the harmonics of the MEMBRANE

The "Morphic Resonance" (Ringing by Shape Pattern) frequency FIT of the "Lock and Key" - IS Immune Identity.

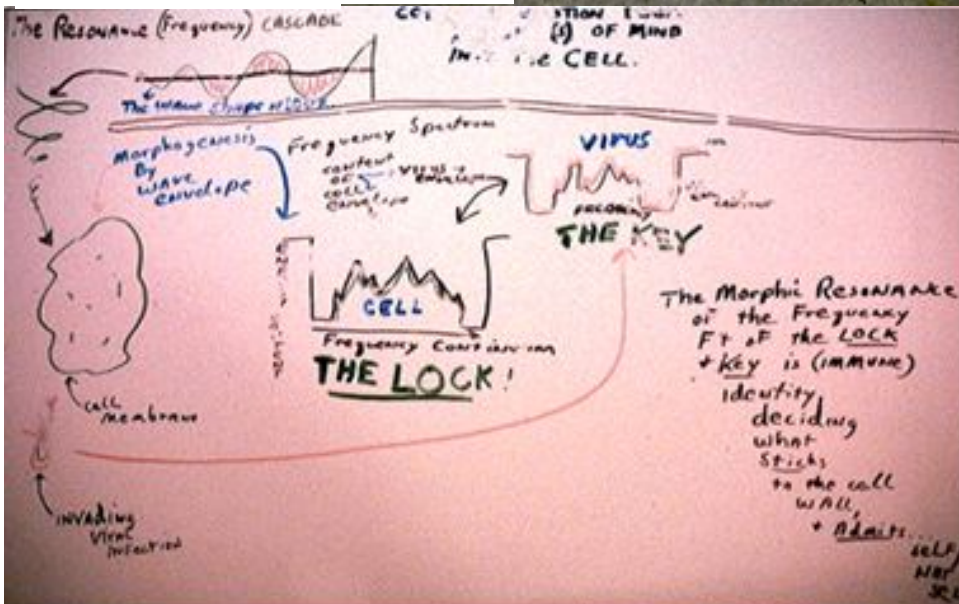
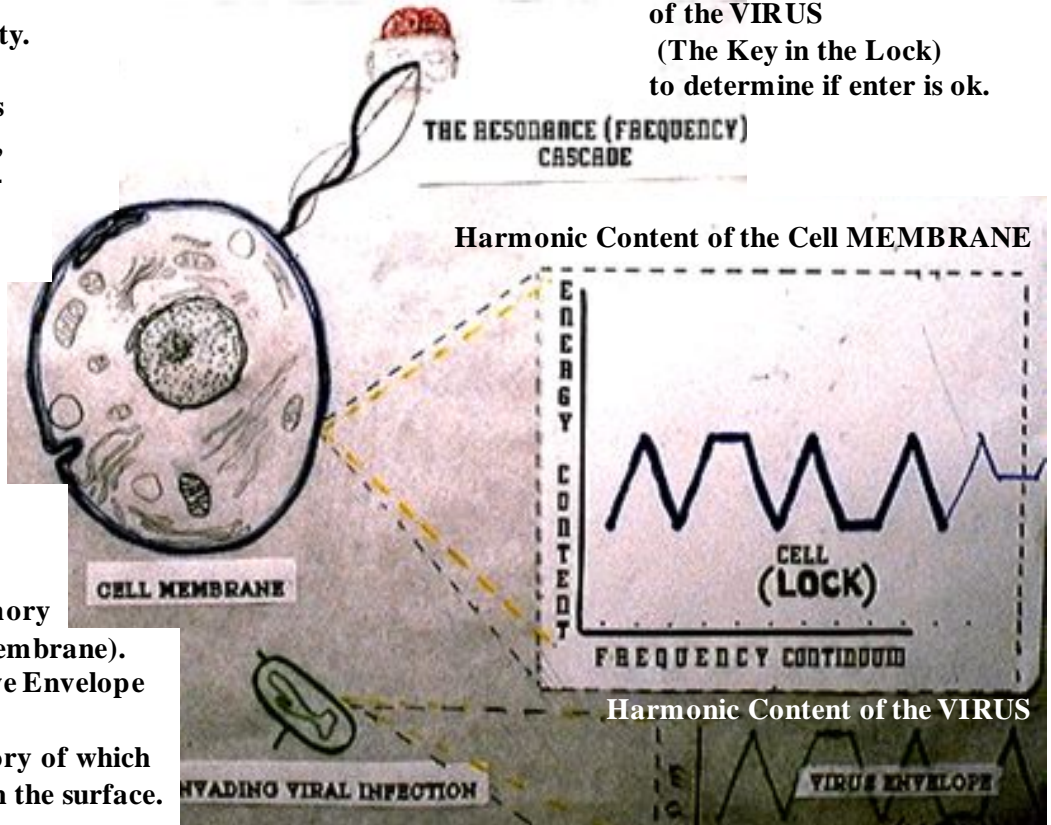
Deciding what fits into the Cell Wall, and is Admitted - by RESONANCE is the gate-keeper ("self/notself") decision of the Immune System.

Frequency Spectrum / FOLDEDNESS - is the Content and Memory of the Cell envelope (Membrane). MorphoGenesis by Wave Envelope

The SHAPE tells the story of which emotions have folded on the surface.

Key in the Lock  
The WAVE Envelope of Love? Coherent Emotion Pours the Orders of FEELING into the CELL

Harmonic Content of the Cell Membrane- is COMPARED to the Harmonic Content of the VIRUS (The Key in the Lock) to determine if enter is ok.



Frequency Fit ('Key in Lock')  
Harmonic Inclusiveness Of the Membrane Tests the Harmonic Inclusiveness Of the 'virus' To test for Admission (Source of Immune Identity) -- also see "Structural Stability & Morphogenesis" text: Music Of the Membranes.. Also: "Laws of Form"

'Popping the QWF'  
Which Waves Lengths /phase angles  
Add spin to soap bubbles-  
Making immune systems.





In order to ATTRACT CHARGE - the electric waves of life we call SPIRIT - you MUST learn to compress charge well. This is because this is what starts the SUCTION TO CENTER OF THESE WAVES OF CHARGE. The name for the moment when this SUCTION OF CHARGE INTO A CENTER - starts going on and on without stopping is called IMPLOSION. Implosion is easy to understand - it is the opposite of explosion. The waves fall in - or collapse into center. Implosion is key to LIFE FORCE and MAKING GRAVITY and GETTING IMMORTAL (wave SUSTAIN-able). This is why the adult book on this is called IMPLOSION's GRAND ATTRACTOR ( goldenmean.info/newbook ).

The PRINCIPLE of what is life - for science is - **LIFE FORCE equals the ability to FRACTALLY ATTRACT (by compression geometry) and SELF ORGANIZE this ELECTRICAL CHARGE.**

Once you understand how the shape of a rose or a pine cone is arranged to allow continuing (infinite) perfect compression of this CHARGE - you can begin to visualize LIFE. This is because this is how you start waves sucking in to center. (IMPLOSION). This is what we mean by TO DIMPLE - and TO MAKE HEART. This principle (RULE) for WHAT IS LIFE needs to completely change how science designs things like houses and refrigerators - because we now know that things which bleed electrical charge cause death. This can be measured with seeds 'germinating' (seeds that start growing successfully)- and measured by looking at charge waves harmonics ( goldenmean.info/biophoton ). The more waves of charge which can arrive anywhere at once - the more alive that place is!

The principle or rule- that allows the MOST number of waves of charge to get into one place at once - is - you guessed it - GOLDEN MEAN!

This is why - the GOLDEN MEAN is the geometry (shape ) of EVERYTHING THAT IS ALIVE . (all living molecules / proteins are 5 sided - because that is how GOLDEN MEAN nests).

Many of these things we are explaining to you kids here - your scientists don't know yet. It is not because these things are not correct in science - that they don't know . It is rather that they are stubborn. Another rule in science, is that when you learn something new - you need to wait for one whole generation (lifetime) of scientists to die - before you can teach something new. For example - scientists don't know yet that attracting charge is the principle of life . They won't admit that compressing charge into speed (acceleration) by Golden Ratio is GRAVITY (suction thru light speed).

You can help speed up the evolution of the stubborn scientists by teasing them every time you have the chance. Ask them - why does a thing fall to the ground? Ask them - why do you lose weight at the instant of death? Ask them why meditators float off the ground - make gravity? Ask them how does anything (like your blood DNA - BECOME a CENTER of GRAVITY? Ask them - if they really believe that the DNA in your blood is only a tinkertoy to hook proteins together - instead of a FIELD EFFECT of CHARGE WAVES? It is important to get stubborn scientists to understand that your blood DNA CHARGE FIELD must get coherent - because this will tell them how to die - and how to not destroy DNA (with genetic engineering).

In fact - the **ORIGINAL meaning of ROYAL BLOOD / or BLUE BLOOD- was CHARGE RADIANT - charge glowing blood!** The color of the charge came from THOSE WHO HAD THE MOST COMPASSION and embedding with the land and the genes (the blood DNA) of everyone. So the ROYAL one was the one who FELT the most for everything alive! The good royal blood would SING with the 'piezo-electric' ringing of ALL the DNA around - and it's FEELING! This was called SAN GRAAL - the SONG IN THE BLOOD. It is part of the ringing you hear in your ears before clair-audience, during bliss and kundalini and so on. It is the voice of the collective speaking .

AND - the word for royal is related to the word rex to rule and the word for PURPLE.. or INDIGO. When the frequency of BLUE gets high enough (color is the tilt of the photon as a donut - the donut tilts around)- the eye sees a bit of red with the blue (the octave 440-880 angstroms IS a donut) - and calls it PURPLE! This is the color of the light (Ultra Violet or UV) which comes from DNA which is on FIRE. (Bliss ignited and so on).

AND - this brings us to the INDIGO CHILDREN story!

--

## What does Indigo Child mean?

In this book, we suggest that science and biology is going to need more info than the current way INDIGO CHILD is described. You see - when we provide only a psychology or a soft subjective picture of what is a certain kind of 'magical' child - this description can never be really SHARED - because it can never be measured. We really need something that creates science because this possibility of measuring something IS WHAT MAKES IDEAS SHAREABLE and IMMORTAL.

So - let us begin with the old description:

*"What is an indigo Child? -from <http://www.indigochild.com/>*

- \* They come into the world with a feeling of royalty (and often act like it)*
- \* They have a feeling of "deserving to be here," and are surprised when others don't share that.*
- \* Self-worth is not a big issue. They often tell the parents "who they are."*
- \* They have difficulty with absolute authority (authority without explanation or choice).*
- \* They simply will not do certain things; for example, waiting in line is difficult for them.*
- \* They get frustrated with systems that are ritually oriented and don't require creative thought.*
- \* They often see better ways of doing things, both at home and in school, which makes them seem like "system busters" (nonconforming to any system).*
- \* They seem antisocial unless they are with their own kind. If there are no others of like consciousness around them, they often turn inward, feeling like no other human understands them. School is often extremely difficult for them socially.*
- \* They will not respond to "guilt" discipline ("Wait till your father gets home and finds out what you did").*
- \* They are not shy in letting you know what they need."*

Our new description is going to be more helpful because it describes a connection to science. AND because it shows some PURE PRINCIPLE (something shareable - something of ESSENCE). If the quality of INDIGO CHILD were understood in science, using measurement as a tool, then the skill to develop those qualities could be taught and shared. Measurement makes ideas shareable. Implosion is the FUSION (being fused or becoming ONE from MANY) - which results when waves (ideas) become shareable.

We will see that **the BLUE or PURPLE in the field or aura of the young person - is ability to radiate electric CHARGE. This is what is called INDIGO. "CHARGE RADIANCE" is what you should look for when you decide who you would like to HUG!** This charge field of electrical energy is measured using capacitors. ([goldenmean.info/biophoton](http://goldenmean.info/biophoton) ). This CHARGE field contains the ability to store in a field effect all the INFORMATION of your biology memory. This field used to be called SPIRIT or ORGONE or CHI or BARRAKAH or SHAKTI or ECK or ... ( [goldenmean.info/namesforspirit](http://goldenmean.info/namesforspirit) ) . It is more correct, and accurate to use science to describe these things because otherwise language is not accurate enough to produce agreement. PLUS using science now to describe spirit MAKES SPIRITUAL IDEAS MORE ROMANTIC AND INTERESTING not less. Science means religions don't have to continue being the greatest cause of war on this planet - because science is about producing agreement based on pure principle.

This electrical field of charge is the ability for you to become sustainable - IMMORTAL! Talking about INDIGO children using something MEASURABLE changes everything - because then it becomes shareable - this is the purpose of using science.

The qualities that make you self steering - and able to decide from within - IS EXACTLY THE CHARGE IMPLOSION of BLISS and ability to create FIRE from INSIDE YOU. Could this be what we mean when we say: AS YOU THINK IN YOUR





HEART - so you ARE. Remember- where you START COMPRESSION - you DIMPLE- and you MAKE HEART! This is the point you STEER YOUR AURA FROM. Now understand deeply what was called center of gravity - your power point- is your center of CHARGE that is IMPLODING.

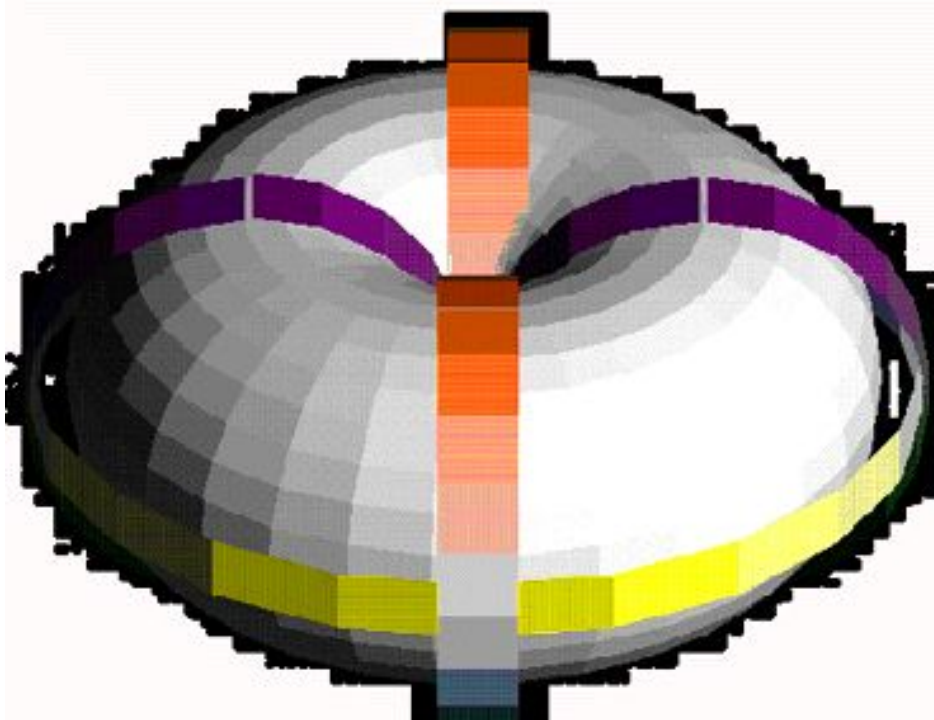
So as we look now at INDIGO as a name for CHARGE FIRE inside your body and blood - think about how this makes you independent and powerful inside. There is a connection between getting your own source of DIRECTION and getting your own source of CHARGE. This shows up in the blue (or INDIGO) charge RADIATING around you!! (Hint: getting BLISS and ECSTASY charging you from inside - even while YOUNG is the REAL - INDIGO child!) This is what is behind the wonderful self-directing quality for INDIGO children talked about above. PLUS once we understand this ability to get charge - we can MEASURE the INDIGO in the aura of CHARGE around you.



*In the blue becoming purple light that you can see - the rainbow turns upward toward blue. You see a bit of purple at the tip of the blue. Light you can see goes from red - a longer wave - to blue a shorter wave. Color is your eye's way of measuring the tilt or angle of the photon or bubble of light as it hits the back of your eye (the 'cones' where you see color).*

When your eye sees the donut shaped photon of light about to tilt back around to where it started - that is where the little bit of red merges again with the blue. It has come the full circle. Because light travels as a donut.. a kind of figure of 8, the waves of light are about **one octave from red to blue**. (In the proportion or ratio of 1 to 2).

Since blue is a shorter wave length, information and pattern there is more compressed - closer together. (More memory can fit in short waves- high frequencies). For example, in your cells - when you finish digesting your food - you turn the energy in the food gradually into high quality BLUE LIGHT. The higher frequencies of blue light are called ULTRA VIOLET light. The VIOLET is sometimes called INDIGO meaning a deep or high frequency blue.



This high quality ULTRA VIOLET (indigo blue) light is called the motor which drives the cell by scientists. Your living cells in you body, are like an orchestra - in order for everything to happen on time and lined up, very fine music is needed to keep everyone arranged (in 'sync' means aligned or nested nicely together). The high quality blue light made by you cells is the music which keeps things lined up. Things like cancer for example happen when the wall of each cell can no longer allow the blue light to pass and be shared with other cells. ([goldenmean.info/cancer](http://goldenmean.info/cancer))

When your cells in your body divide - just like you did when you were an egg - one cell- inside your mother - it is important that this high quality light ( blue fire) be ORDERLY OR COHERENT. Cell division is kind of like

having sex for cells. Sex is one way to start the juices of ecstasy and bliss. In fact - with healthy sexual loving you can see high quality blue light glowing around the body of lovers. The word for this is COCOON - and is a hint about the movie by that name. When your emotion is coherent or ordered you made a cocoon of this excellent light and waves of charge - and it is this bubble that allows you to start to get immortal.

So what does this have to do with Indigo Children?

Well, when our ancestors came here from space (the Annunaki in Sumeria) to create humans (Adam and Eve) - they had a serious blood DNA problem. That **problem in their genes (blood DNA) - was called NEPHELM.** **This word means FALLEN.** (In Sumerian and in the Bible). This is important stuff to understand because it tells more about why BLISS is very necessary.

You see, **the reason their blood fell - was because THEY LOST BLISS.** When they lost passion and bliss (don't you ever do that please) - then they began to look like the BORGs in Star Trek. In the Bible this is called GOLEM and means someone without a soul. In science what this means is that the braided (nested) worm of DNA in their blood stopped IMPLODING and COMPRESSING charge thru the speed of light. **The result of loss of BLISS and IMPLOSION in blood DNA is that their is no spreading of this high BLUE LIGHT and waves of CHARGE from the cells.** This was how THE SHINING ONES -stopped SHINING... ooops.

This is why in the movie THEY LIVE - the people who lost their soul are seen to have no aura if you see them thru dark blue glasses. As you get closer to BLISS and ECSTASY and more sensitive - you begin to see this blue glow around peoples bodies. This is because the increased charge around the little 'hologram' where your brain sees - can sort out shorter waves and higher frequencies. This privilege comes with the challenge - that as you get more sensitive you become less able to spend time in bad charge places like metal buildings with bad air (most stores etc.)

The movie "**Total Recall**" about Mars returning to Oxygen in her air is a clue to our 'fallen' Draco Annunaki Ancestors. They used Mars as a planning area to launch Earth colonies. Part of Enki's blood (the RA in the Ab-RA-ham of religion) came from Rigel in Orion (blue - copper rich - blue blood today became a symbol of royalty). As their ancestors lost fire in their blood, they lost ability to survive in Oxygen rich air. So it became a symbol of who was winning in those ancient **ORION WARS** - who was deciding how much Oxygen was in the air. Later the wars - called "**Empire Strikes Back**" in Star Wars - is these battles. And they were often actually called THE OXYGEN WARS.

The fallen or parasite (no BLISS - no inside source of their own CHARGE) group became unable to stand IMPLOSION and OXYGEN. This is why vampires die in sunlight. Because lo quality DNA cannot survive near real FIRE. This is because deep oxygen fed FIRE of IMPLOSION in the blood is the perfect way to SORT for what is shareable! Most cancer and AIDS cures are actually ways to get more OXYGEN in the blood. If you would remember to BREATHE deep in REAL AIR - these diseases would go away. - A useful after thought to these ideas is to realize that today there are many fallen and parasite 'shapeshifter' type beings inhabiting our government. The wives important military leaders and media power people have several times independently reported seeing their husbands body taken over by reptilian types. The shape shift is hard to see BUT - (here is the clue) - **if you pump higher OXYGEN into your government buildings - all the parasites would DIE!!!** More on all this in RETURN OF ENKI - [goldenmean.info/enki](http://goldenmean.info/enki)

Those parasite types are definitely not happy about teaching young people to find BLISS - because people with this FIRE inside will never be food for parasites. If you make the decision to FOLLOW YOUR OWN BLISS - expect to make your own decisions - take responsibility!

The reason our ancestors lost the FIRE in the blood DNA (became FALLEN) was because they did not carefully keep life force. TAKE CHARGE! They allowed their bodies to be too close to metal and things which bleed charge too much. (Do you notice that people who live and work in metal buildings start to look like they are losing their soul?). As they began to lose the ability to attract and compress charge (life force) - they began to desperately look for outside things to replace what they were supposed to make inside their bodies.

**This is called ADDICTION. Addiction is anything external (outside you) you use to try to get BLISS.**



You can always tell ADDICTIVE actions because they increase wasteful mucous (slime) in you body. (This is why you sneeze and blow your nose when you eat white flour or dairy).

Examples of addiction are coffee (caffeine), alcohol, cigarettes, drugs and so on. Beer for example reduces oxygen in your brain - falsely imitating bliss. During bliss the brain does not require oxygen to maintain fire, because long wave charge IMPLOSION COMPRESSION - allows you to INHABIT that. This is why Yogis can live a long time without breathing. Don't try it until your inner voice says ok.

Well- those ancestors who did genetic engineering to make Adam and Eve - were addicted to a WHITE GOLD POWDER - called ORMES, the SPICE, or MANNA. This is the origin of HOLY COMMUNION- white tablet - in church. They crossed the blood of our ancestor (cro magnon) to make the first human - because they wanted help mining this Gold. (full story [goldenmean.info/enki](http://goldenmean.info/enki))

**They were looking for a heart of gold - BECAUSE they were growing old.** When your heart learns to compress (make Golden Mean - 'make gold') - then the BLISSFUL charge compression prevents growing old! So there was something wonderfully true about this famous song.

The white gold powder imitated implosion in the blood - while HEART and PASSION made blood implosion when started inside CAN make you immortal (not grow old). Various ways to compress charge into a stable wave - can prevent aging for a while. Capacitors called stone dolmen (like Stonehenge) can set up a charge field to prevent aging. Doing this artificially was kind of a problem for our ancestors.

One form of **this electrical charge wave to stop aging - was called the Garden of Eden.** The fence was the edge of a wave field (held up by 6 Capacitor Towers - which focus CHARGE like a lens). The technology to use an electrical field to prevent bodies from aging was standard mining equipment for those Annunaki. The problem was that **using TECHNOLOGY to get immortal - without POWER charge - BLISS- FROM INSIDE - cost them the secret of immortal soul.** (read the symptoms below)

**The simple truth is the DNA in your blood was designed to be ignited into GRAVITY making - star moving IMPLOSION. Without this next step (BLISS and ECSTACY) - all you get is DEAD! The fact that Earth scientists still don't know what DNA in blood is for - is only a statement of their stupidity. The science of IMPLOSION in DNA is not that hard to measure. ( [goldenmean.info/superDNA](http://goldenmean.info/superDNA) )**

So - getting back to our story: The symptoms or problems caused by loss of BLISS and PASSION and IMPLOSION in blood DNA were very serious. All of **these problems happen just when you stopped making this HIGH QUALITY BLUE LIGHT. Let's call it the INDIGO FIELD. When your blood and cells stop radiating or spreading this charge wave - you were called FALLEN or NEPHILIM.** ( You could think: "no PHI golden ratio of EL tum in them-Ne-PHI-EL-M").

**So when you look for blue fire - the INDIGO FIELD around someone's body - you are really checking to see if they have FIRE IN THEIR BLOOD. The IMPLOSION of CHARGE we teach about as BLISS and ECSTACY and ENLIGHTENMENT in this book - are how you make this INDIGO FIELD.**

*The problems we observe for those who fall like this are: (symptoms of the disease of loss of ensoulment)*

- loss of the ability to lucid dream - or dream clearly.*
- loss of the ability to take memory (charge waves) thru death (compression/acceleration). (thru light speed)*
- loss of the ability to time travel without embarrassing need for metal craft (DNA's electrical field is made for time travel and a metal craft which is a leaky capacitor only prevents the necessary COHERENT waves of charge). (Vairachoca- SUN GODS are those who can!)*
- loss of the ability to strongly radiate (immune system) health into your babies from the thymus around your heart. (the thymus looks like a catchers mit for the heart's bliss- it is where you take responsibility - mea culpa-).*
- rapid shortening of life years*
- decreasing use of hi quality oxygen*
- increase of draw to addiction*
- loss of ability to self steer (increase of HIVE MIND -) loss of independent thinking.*

**If you would like to avoid these problems of FALLEN charge in the blood -it is important that we do the homework to learn BLISS principles.**

So - what have we learned about an INDIGO CHILD (one who has an INDIGO FIELD around their blood)?

1. An indigo child is anyone who has learned to attract and radiate charge (Bliss) well.
2. The blood DNA is naturally aware that it is fatal, mortal to be stuck below the speed of light - so it takes every opportunity it can to try to squirt up to speed (blue fire). If you help your blood to get this squirt of blue fire up thru the speed of light - by learning to eat charge ('twinkle') - then you can get immortal. Bliss - ecstasy and enlightenment are just the temporary words we use for the real science of immortality.
3. We are growing and evolving more and more young people who really are a hope for the future. They will have this skill - which they mostly learned thru many lifetimes. But if we are to serve these magical children - we must offer and teach them conditions for keeping and growing this CHARGE of life force in principle. That is what this book is for.

**The magical or Indigo child idea is helpful in that it points us to hope. But to run with this inspiration - we must teach principles - not magic and miracles. Magic and miracles are a name for - stop trying to understand for yourself. Yet - knowing from inside the principle or rule which makes things work - is what allows you inside to steer and self direct.**

For example - the way **an indigo child can see colors thru their fingers or the top of their head** - is wonderful - but it is not a miracle. I began seeing colors thru the top of my head when I began having 'Kundalini' bliss many years ago. How you see things is how you focus waves of charge. That is why just focusing on someone can help heal them. So when you learn to get charge in focus - you begin seeing many things. The important question to ask is HOW does bliss in your heart cause to blood DNA to begin spreading this BLUE FIRE- the real science of INDIGO FIELD?

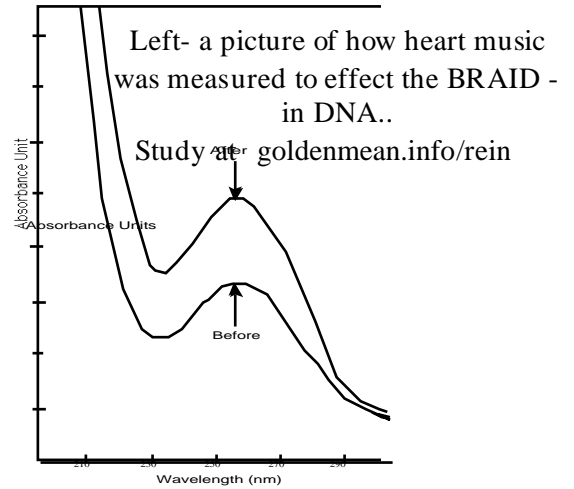
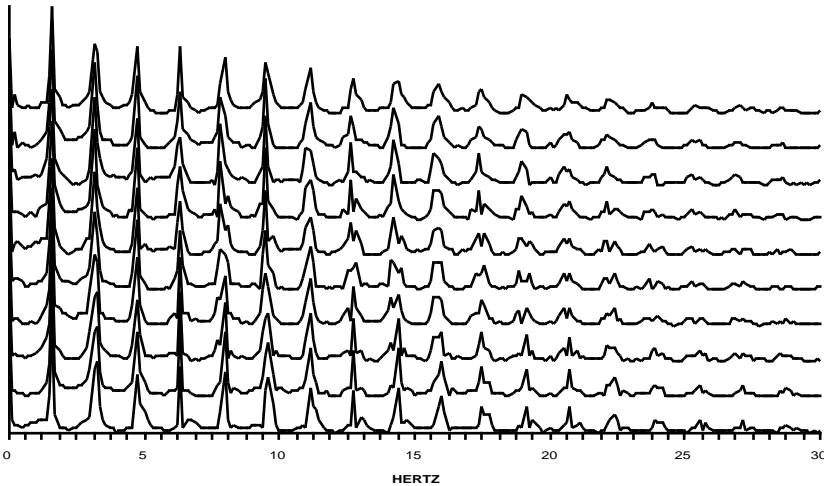
The way it works is that during COMPASSION and BLISS your heart begins to make lo frequency music notes - which together make what is called a CASCADE. A cascade for example happens in a waterfall. You have wave after wave in a nice pattern.

When you have the RUSH of feeling in your heart - we can pick up the music notes of this cascade right from your EKG (Electro Cardio Gram). This is the electric your heart makes. **By checking for which notes are in your hearts music we can identify empathy - compassion - even bliss.**

( See the HeartTuner - [heartcoherence.com](http://heartcoherence.com) ).



We suggested our friend Glen Rein - measure the effect of this ordered long waves of heart music on DNA. And sure enough- the sound of the heart in bliss (heart music which becomes ordered) - actually braids and programs (lines up in nesting ) your blood DNA!



This is important because - - you need to understand HOW it is that **BLISS and ECSTASY** will ignite your **BLOOD DNA** to be **IMMORTAL**. Implosion - compression caused by **BRAIDING** in your DNA - **IS the secret to how EMOTION's program DNA!** ( Braiding DNA-Is Emotion the Weaver - chapter in Dan Winter book 1 - **Alphabet of the Heart** , also [goldenmean.info/braidingDNA/BraidingDNA.html](http://goldenmean.info/braidingDNA/BraidingDNA.html) )

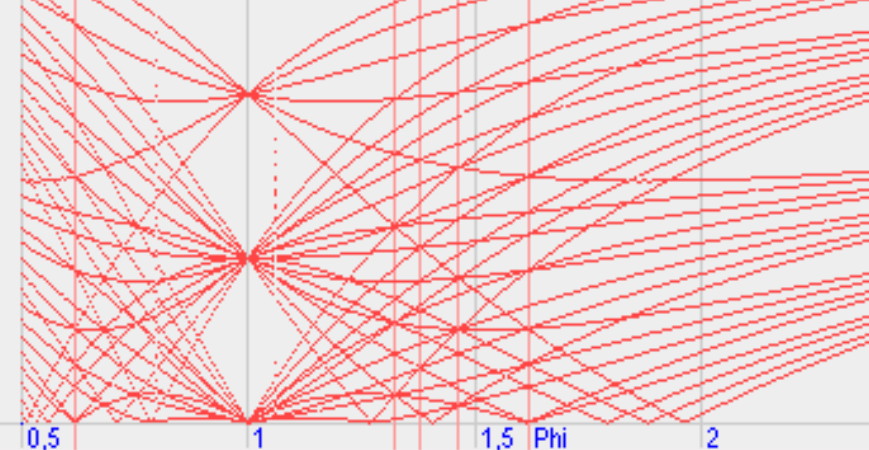
Think carefully about all the pictures we have shared about **how COMPRESSION turns in to ACCELERATION - (IMPLOSION) and visualize your DNA. This is your IMAGINATION shape picture to prepare for BLISS - AND - DEATH!**

What happens is a sound 'pony tail' from your heart - acts like a snake charmer to arranged the coiling of the DNA serpent. The name in science for this principle or rule - that allows long waves of sound to connect to short waves of electric - is called **PIEZO-ELECTRIC**. This just means **ELECTRIC on FIRE!** Usually nature uses slinky or helix like shapes for this - for example your DNA and Quartz both have an inner shape like a helix or slinky. This simply connects long waves to short waves. This is done by braiding - just like you braid your little sisters pony tail - except during **BLISS** - the **SOUND** of your heart does the braiding in your blood.

When the ratio or pattern in the braiding is based on **GOLDEN MEAN** from the heart - then your DNA can coil up one layer inside the other better. This making of a coil with a coil - perfectly nested is called **FRACTAL** (remember our pictures).

When the nesting of braid inside braid inside braid (coil in coil) in DNA is perfect - then **GOLDEN RATIO** carries spin from really long waves into really short ones. This is how the energy or inertia of your heart gets into your blood DNA when you send the spin on the Golden Mean cascade!

**When frequencies combine in Golden Ratio they compress best.. this is how your heart EKG discovered COMPASSION! see [heartcoherence.com](http://heartcoherence.com) HARMONIC EXPLORER**



This is also how when you hug someone using the Golden Ratio shaped **SQUEEZE**- they sometimes feel a tingle in their **BLOOD!**

( Sentic: [goldenmean.info/touch](http://goldenmean.info/touch) )

We think the word **LOVE** comes from this **Long wave PHi** shape or **LO-PHI**.

Teach your blood DNA to accept added spin in this way. (It is called RECURSION - it means- the inside keeps fitting into a bigger outside - again and again). Eventually your blood begins sucking charge down this perfect ladder or cascade. The **shape of the ladder or cascade of musical waves (in your heart OR brain) which attracts and compresses this charge perfectly - is called THE CADDEUCEUS.**

This is the symbol of HEALING, and of Thoth- Hermes-Enki - AND of genetic know how! It is the frequency or wave length recipe for PERFECT COMPRESSION and IMPLOSION and BLISS and ECSTACY and ENLIGHTENMENT.

Even the word EC-stacy means  
**ECK (CHARGE) in STASIS (the STANDS).**

(Eckankar spiritual movement: 'Waves of ECK' = waves of CHARGE )  
So now you understand how BLISS makes you an INDIGO CHILD. We should not just wait for miracles from our children - we must actively be there to create the right space for this BLISS to grow. *Learning about the science that puts our youth into the INDIGO FIELD is how.*

We are getting closer to the real powerful homework for this book. The homework assignment is to start to re-fix a few things in your life so you can get the bliss and ecstasy and enlightenment necessary to make you immortal. (wave SUSTAIN-able).

**Once we understand that waves of electrical charge create immortality and bliss - we can take the steps necessary to become immortal.**

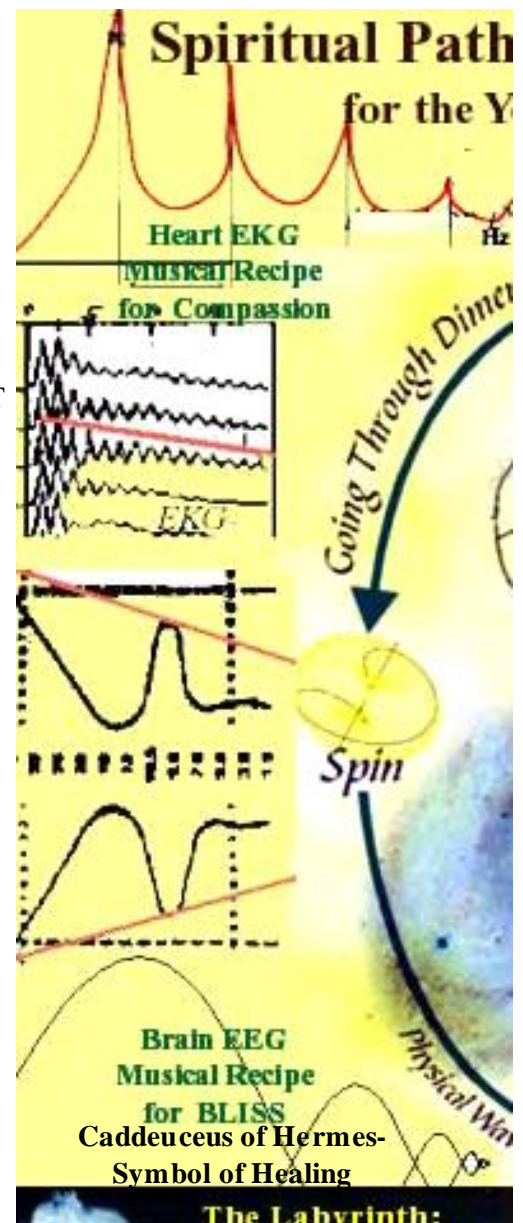
*We will talk more about- the secrets of immortality!*

If it is true - this **BLISS & ECSTACY & ENLIGHTENMENT is the only way for you to get sustainable and immortal** - (the science is simple and clear) then no one could possibly deny that **BLISS & ECSTACY & ENLIGHTENMENT were the only long term reason for being alive - and the only reason to have a national government.** This means that politics and government like architects need to be re-invented. They need to start over - now that we know what people are for and what life is. Religion AND government that does not act upon the principle of BLISS based on science - is mostly obsolete and misguided. If someone told you getting immortal was easy if you followed simple principles of holding charge, would you still pass laws based on death?

**Immortality is not vain or too proud a goal. It is the necessary and only sustainable destiny for those who discover what (waves/charge/ideas/emotions) can become infinitely SHAREABLE.**

**It can be mapped and diagrammed electrically in what happens to the charge in DNA. Perfect compression is possible when the perfect (& fractal) symmetry or pattern of the shareable is chosen. That compression turns into acceleration in DNA in your blood - when you die or get bliss - and the charge bubble (envelope or KA) can travel in a life of its own. Your soul.**

If your school or hospital were full of metal and dizzy magnetism that bleeds charge and prevents attention-creating only death - would that not be a problem for your president? This book is for kids - because the big people are too slow to act on the news about how to get immortal. Kids- here is the news - once you act on the new information about BLISS - you can re-invent your government the same way you re-shape your music concert based on the SCIENCE of BLISS. ([goldenmean.info/rainbowserpent](http://goldenmean.info/rainbowserpent))





It really isn't hard to sell the idea that **BLISS is the perfect thing to focus on**. What we really need to do - now that **this is SCIENCE and religion combined** - is get serious about teaching it practically! Not only is **BLISS and Ecstasy and ENLIGHTENMENT - the only way to get your blood's DNA ignited to be immortal (sustainable) AND the best way to get healthy cells ('Immune' system) - AND the best way to INFORM-ING YOURSELF (below: bliss the final educator) - BLISS is ALSO - BLISSFUL**. Therefore - what's really cool about bliss is that it is also - the happiest thing to do! - It is the most sacred (sustainable) thing to do!!

*For example- here is how to explain to your school director - why and how BLISS is the ultimate form education can take: All of biology (people and cells and everything alive) is constantly taking the shape directed by electrical charge. IF YOU SHAPE THAT CHARGE WELL - then presto you have:*

- +the science behind magic
- +the science behind Kirlian and aura pictures
- +the science behind astrology (charge imploded goes faster than light and makes gravity)
- +the secret of life: HOW CAPACITORS COMMUNICATE ( [goldenmean.info/biophoton](http://goldenmean.info/biophoton) for measurements)
- +the science behind 'sensitive crystallization' pics in Steiner, & Emoto "Messages from Water" pics.
- +the science behind Homeopathy ( shake up the medicine: unpack the CHARGE into longer wave)
- +the science behind surviving death ( DNA squeeze your charge thru light speed using bliss - & get immortal).

When your school director asks you how to use BLISS to pass examinations - here is how you start your answer. First- show him or her this book and say - Dan wrote this not because he was taught by University of Detroit OR because he was taught to be SYSTEMS ANALYST at IBM - no he wrote this from 30 years of intense tear dripping nectar sweet bliss. See kundalini in science - [goldenmean.info/kundalini](http://goldenmean.info/kundalini)

When you enter the stillness of bliss- infinite charge can be compressed into your body. This is the ultimate form and expression possible for all biological information. This means that all other sources of information (your school etc.) are merely an introduction to having access to information directly. In the same way that the Internet made libraries mostly (but not entirely) obsolete - BLISS makes school obsolete.

This is NOT to say you do not need school!! But this does mean, that the major purpose of school is to lead you to bliss. AND once you have a source of BLISS ( self direction) then school is only helpful for a while to get you understanding your bliss.

We need to be clear here - because - it would be bad for you to use this book to tell your parents you are quitting school. If you get bliss without understanding the shape of the charge that comes to you - then you get put in the hospital for insanity. This is VERY common!! Doctors usually mistake kundalini for schizophrenia - because they do not really know what either one is. Un-'grounded' BLISS and 'kundalini' is like a radio with so many stations the tuner can't focus to sort .

ONLY understanding the PURE PRINCIPLES behind these waves of charge (spirit) enables you to steer them. The sooner we grow up and stop assuming that God and Magic means - you can't understand for yourself- the better. Magic is a name used only until the student understands a bit of science, and then the better term is charge compression. Divination is merely a name for the fact that charge compression only sustains when branched fractally.. di vine.

The beauty AND the limitation of magic and religion is that they deal only in the subjective and nowhere touch the realm of the measurable - and therefore infinitely shareable. Immortality is the discovery of what can propagate infinitely thru compression - the task of DNA at death.

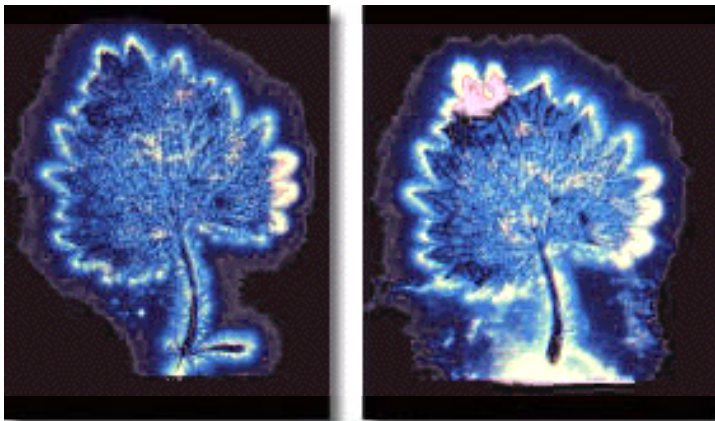
If we wish to now add the science of perfected compression (creation and 'magic') using golden mean, we need to add another level of discipline based on science.

For example- the magical idea of golem creation  
<http://www.fortunecity.com/roswell/leadbeater/0/231golem.htm>  
 is not supernatural because in fact to make a soul-less one  
 is sub natural, and is more the problem than the solution

**Golem:** pic& quote from:

<http://www.thecards.com/fullpage/golem.html>  
 “Synthetic, artificial in nature, a creation of humanity,  
 soulless. - Animate, yet without life, the Golem is the  
 epitome of humanity's unnatural creations. While the  
 Golem bears superficial tokens of human nature and  
 appearance, it exists outside of the natural cycles of life  
 and death. It has no inner beauty, nor does it have any  
 intrinsic ties to nature itself. “

Making a ‘golem’ involves gluing together a sequence of  
 magnetic domains (shadows of donut / toroid / electrical  
 fields - called Hebrew letters), in the sequence to imitate  
 biology. This uses the continuing shadow of the charge  
 field in the optical cortex (high brain) where the visualiza-  
 tion - inner picture - is focused. (You make the shape of a  
 sequence of Hebrew letter focused inside your head).



**Here:”Phantom Leaf Effect’ Kirlian photo shows how  
 the charge field can remain after the leaf (the picture in  
 your brain) is torn. This is the science behind magic.  
 IMAGE THANKS: George Hadjo & VALERIE!!**

was their last breath to get implosion in blood - fire in DNA going. Addiction - like this, is a wrong turn on the  
 path to bliss - externalizing - making from outside you- the process of IMPLOSION/ attracting charge. The  
 process completely fails to deal with the issue of what makes a soul, or what makes DNA in blood able to  
 make gravity. Your creations do not have to be soul-less (unsustainable and completely parasitic).

**Parasitic is what golem makers & genetic engineers are until they understand the true physics of bliss -  
 which is what gives access to the charge compression - your own source of self direction** (not available to  
 the golem).

We are trying here with much illustration to make this science of why bliss hygiene (implosion based on golden  
 charge compression) as the ONLY source of immortality - ensoulment - which from a certain perspective is the  
 opposite of golem making- understandable simply.

The problem of Yalweh (Enlil)- the ‘encoder’ in ‘Bible Code 2’, was precisely his failure to understand this  
 passion which makes fire in DNA. In that book, while he can see Jerusalem destroyed in the near future  
 AGAIN by nuclear blast - cannot change it. The Tron or the Winged One is the one who has charge implosion

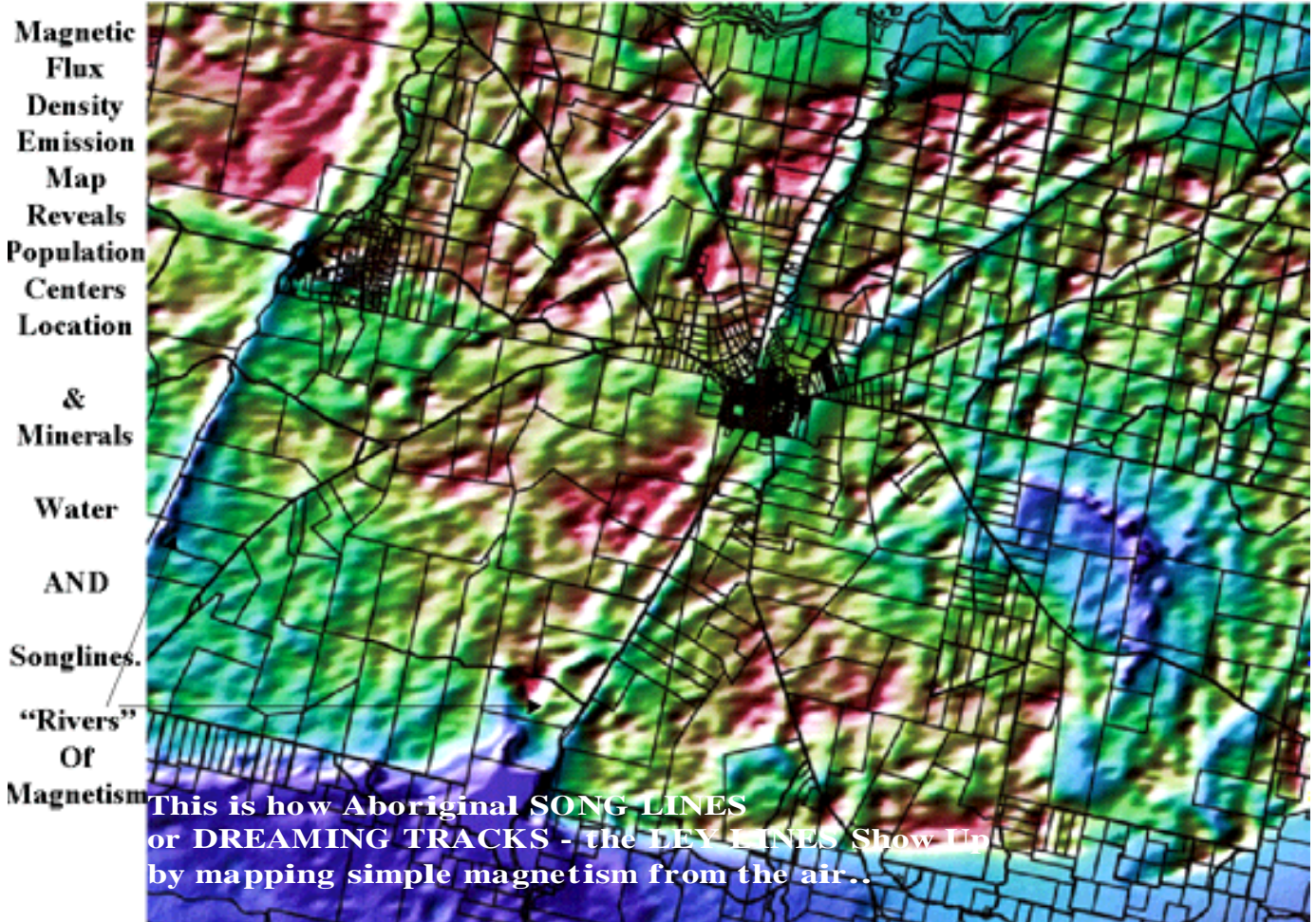
This is how our ‘Ibi-uru Annunaki’ ancestors  
**made Adam & Eve mining slaves to feed their  
 gold powder addictions.** ( [goldenmean.info/enki](http://goldenmean.info/enki)  
 ) The Hebrew alphabet was software for genetic  
 engineering. It was the shadows of the spiral inside  
 the tetra (meeting tent). (donut origins alphabet  
 pics P. 23 & 53 ). **The outside tetra-cube hex  
 shadow (flag of Israel) is soul-less without being  
 animated (Imploded) from within by Golden  
 Mean Spiral.** ( see [goldenmean.info/dnaring](http://goldenmean.info/dnaring) )  
**Only initiating** (beginning) **compression FROM  
 INSIDE** (to dimple - SHEI in Chinese) **makes  
 HEART!**

The white gold powder (Holy Communion) wafer



glowing in blood on fire - from BLISS. This kind of field from your blood CAN time travel & non-destructively modify the future - unlike ENLIL. (BST - Blank State Technology - of wingmakers.com - ignited dna).

Interactive or going back and forth - successfully in time travel is exactly like using a lucid or clear dream. Try to understand WHY Indigenous (Indian / Aboriginal) people are more likely to be able to lucid dream & survive death and keep a soul. By living barefoot on the same land for hundreds of generations, they can fold the shape of their land's magnetism into their DNA fold - making their dream EMBED / GROUND & real. This is also how weather is steered. Now that we have taken their land - we must take responsibility for the dreaming that holds it magnetically together - or we and it will fall apart. (as in Atlantis or "The NeverEnding Story"),



Braidwood - Enhanced Magnetics  
Rob Gourlay orbtek@austarnet.com.au

His group commercially locates water and minerals in addition to ley lines - using airborne magnetic mapping

DNA CAN contain a map of the lands fold - by the braiding we animated in DNA p.41-47. This is what Merlin (the MER line) meant by ARTHUR AND THE LAND ARE ONE. The map is an arc on a torus. The principle of MAGic is- when the resolution or clarity of the map gets hi enough, the map replaces the land. Once the fire in your blood is COHERENT - the magnetism inside embeds or is fractal - self similar to - or GROUNDED - then the field effect can travel. Bliss - blood igniting- turns CHARGE compression into speeding- up / acceleration. Once you go thru the speed of light (using biological implosion in blood DNA) - THEN you must inhabit or live in - or travel in - TIME!! Imagine the 'Tron'- by going faster than light you could get round in the circle move (rotation) we call TIME- to be here before the rest arrive next year!!

**SO - to be inhabitable - or able to live in - shapes (like people and galaxies with spiral arms) must be FRACTAL - BOTH - in SPACE AND in TIME!** We have been childish thinking only human bodies could be lived in. We are about to learn that the BREATH OF LIFE (to ANIMATE) means any shape that can spread CHARGE FRACTALLY from center (like a rose). The ROSY CROSS is the pattern of the spread of that charge

- reaching its wings thru the speed of light - because of fractal self-similarity (think of ROSES or PINE CONES).

See WHY there the 7 arrows thru the tetra - shadows of you guessed it GOLDEN MEAN produce Hebrew, by grabbing and giving a throw in any direction for yourself - at

goldenmean.info/dnaring/spinner

$$\frac{(1 + \sqrt{5})}{2} = 1.61803$$

$$\left(\frac{\pi}{e}\right)^{\frac{7}{5}} = 1.61802$$

The 7 arrows are held together ONLY if phi golden ratio recursion compression implodes the center (the 5 spins inside - of 7 spins outside.. because the symmetry of how 7 spins COULD exist within 7 spins (recursion inside tetra) is based on Golden Mean. This is what JACOB'S wheel MEANS.

Advanced students could ask to discover why PHI golden ratio  $\approx 7/5 \pi/e$   
5 spins inside 7 outside see ANU above.

.618 Golden Mean

$$F([F(\cdot)]) \text{ Recursion } \left[1 + \frac{1}{1 + \frac{1}{\dots}}\right] = \frac{1 + \sqrt{5}}{2}$$

The reason the science of charge compression (physics of precipitation) was named magic is also missed by those who use the word . See the MAG at goldenmean.info/goddess

Astrology (&mag ic) is based on how capacitive charge spreads or radiates to the sustained implosion called gravity.. and life.. Those who would care to understand from the inside out - need to begin by understanding how capacitors communicate. See goldenmean.info/biophoton - the secret of life. **LIFE FORCE is measured by the ability to (fractally) attract and self organize charge.**

**ALL HUMAN INTERACTIONS ARE ABOUT CHARGE ('Celestine Prophecy'). This especially includes the science of choosing whom to hug. - This idea is key to the closing hygiene part of this book.**

Some students will choose to not want to know about science.. not because they do not want to take responsibility -science is the only language this planet has for deep shareability - but rather - they will assume themselves not able to think deeply -and independently for themselves. Sadly - this makes them golem (the opposite of divine). (Visualize this by replaying RETURN OF THE BORGs movies in your mind).

**In short, when you understand how the shape of a capacitor determines the growth of water crystal in a living cell, then we can talk about magic.**

**All of this comes under the category of understanding BLISS as the science and hygiene (life habits) for attracting CHARGE. This is how your blood DNA can ignite. Start with the principles - think globally - but act locally.**

Even down below when we get to the part about the sticky white flour in your pizza being terrible for your guts - you are going to find that the alternatives are actually HAPPIER AND BETTER TASTING TOO. **Bliss is in principle the condition where all the cells in your body get so absolutely happy and contented and vibrating that they begin to sing absolutely in nesting with the CHARGE of all the cells in the WORLD. When this electricity rushes like lightning into you - it leaves a fire in your eyes that will make you irresistible to your friends - not to mention - able to survive death like it was a dream.**

SO - let's get serious and name the steps to get BLISS and ECSTASY and ENLIGHTENMENT. Remember **immortality is not selfish - biology has a correct desire to get sustainable- history teaches this. Losing memory at death was just the inconvenience caused because you were childish enough to store memory (waves of charge inside your body) which were NOT SHAREABLE (coherence gone compressible). Once you learn to store only shareable (COHERENT) emotion and charge inside your muscle and body - then you tingle so much with bliss - that you never die. Biology (your body) merely invented death to gently persuade you to stop storing inside yourself memory which is not shareable ( electricity / CHARGE / 'spirit' that is not coherent and compressible).**



*If you ONLY think&feel what is SHAREABLE you tingle with CHARGE so much: YOU NEVER DIE!*

**Learning to store only SHAREABLE memories (coherent emotion) in your bodies waves - is as easy as learning to recognize instantly whenever new information is pure principle and can serve everyone.** For example - why the Golden Mean ratio creates LIFE - is a pure principle. If you learn this deeply- your DNA will store it and you will have the same memory lifetimes from now - because that information is a SHARE-ABLE - able to spread - charge wave. On the other hand, if your friend starts telling you that someone does not like someone who might not like someone - just useless gossip - you give that no attention - because the information will not survive your dying.

**Death is like a self-denying prophecy** (prediction). Here is how it works - Your Doctor says- you are sick - and predicts you are going to die in some weeks. You go home, and tip over your filing box and **begin to sort for WHAT IS SHAREABLE. Every time to focus on a perfectly shareable idea or emotion ( pure principle ) you feel a little tingle. This tingle - (often your hair stands up) - is sometimes called a warm fuzzy, a jimmy willy - or an angel hug.** Most everyone has had such an experience. Well- finally we know now the science of what causes this to happen whenever you have a really shareable thought or feeling. **Discovering what is really shareable (pure intention) is measured by coherence in its ultimate form FRACTAL COMPRESSION.** When you make the shape of this compressibility (initiate heart squeezing) - **YOU become a FRACTAL ATTRACTOR FOR CHARGE!** Initiate compression - dimpling - then **MAKE HEART!** -so-*Death was invented by biology to gently teach us to stop storing inside-what is not shareable!*

--

*So - let's review - what IS - bliss - ecstasy and enlightenment, and why do you need them to get immortal?*

**Bliss - ecstasy and enlightenment are a gradual process of attracting more and more waves of electrical charge (measured with a 'capacitor' - formerly called 'spirit' or CHI) to your body. The skill to attract this charge means making the place (environment) around your body increasingly charge dense & FRACTAL (more harmonics or wave 'lengths' of charge compress to one space). This is the electrical meaning of SACRED SPACE. The ability to get charge into compression around your body to put together (and make 'fusion') of biology's memory - which takes the FORM of CHARGE- is the real science behind Feng Shui and ancient wisdom.**

**At the time of the RAPTURE (Solar Compression wave) PATTERNS OF CHARGE (matter) in space which is not able to survive squeezing will make heat and die. This is the science behind the Christian 'fire and brimstone' threats about THE RAPTURE. ( and the somewhat ridiculous novels- THE LEFT BEHIND - supposedly about those who don't survive the rapture).**

**Most of the prediction literature (Solar science - AND far out new age stories ) says the rapture - which is the peak maximum of Solar flare action - is due around 2012. Many scientists admit privately that this Solar Wind (Sun magnetic storms) may destroy a lot of Earth. Our view is that this is largely misleading because a great part of the intense possibly life threatening solar wind has already begun reaching Earth, and we will see storms and earthquakes and magnetic problems increasing with a heavy effects even in the next few years. Particularly in 2004 - 2007.**

**The calendar of Maya ("count of days") for example - is mostly important because it was a map to the Sun's pattern of firing. (Tutankhamon Prophecies by Maurice Cotterell ). The pattern of the solar fires is critical to understanding soul growing because it is the grid - the nest - upon which biology gets compressed into acceleration (evolution). In other words - the pattern of the solar fire makes the (pine cone like) nest in which DNA gets the possibility of growing up - which means - getting squirted thru the speed of light into stars.**

**This is the reason the Maya priest says "UNLESS THE DREAM SPELL (charge field of emotion) is ALIVE AND AWAKE IN SYMMETRY SPACE ( coherent enough to MAKE gravity )- EARTH WILL BE BLOWN AWAY IN THE MAGNETIC WIND OF THE SUN." Coherent clear (lucid) dreaming sets up the magnetic fields of Earth with enough IMPLOSION - center making gravity force - to hold us together.**

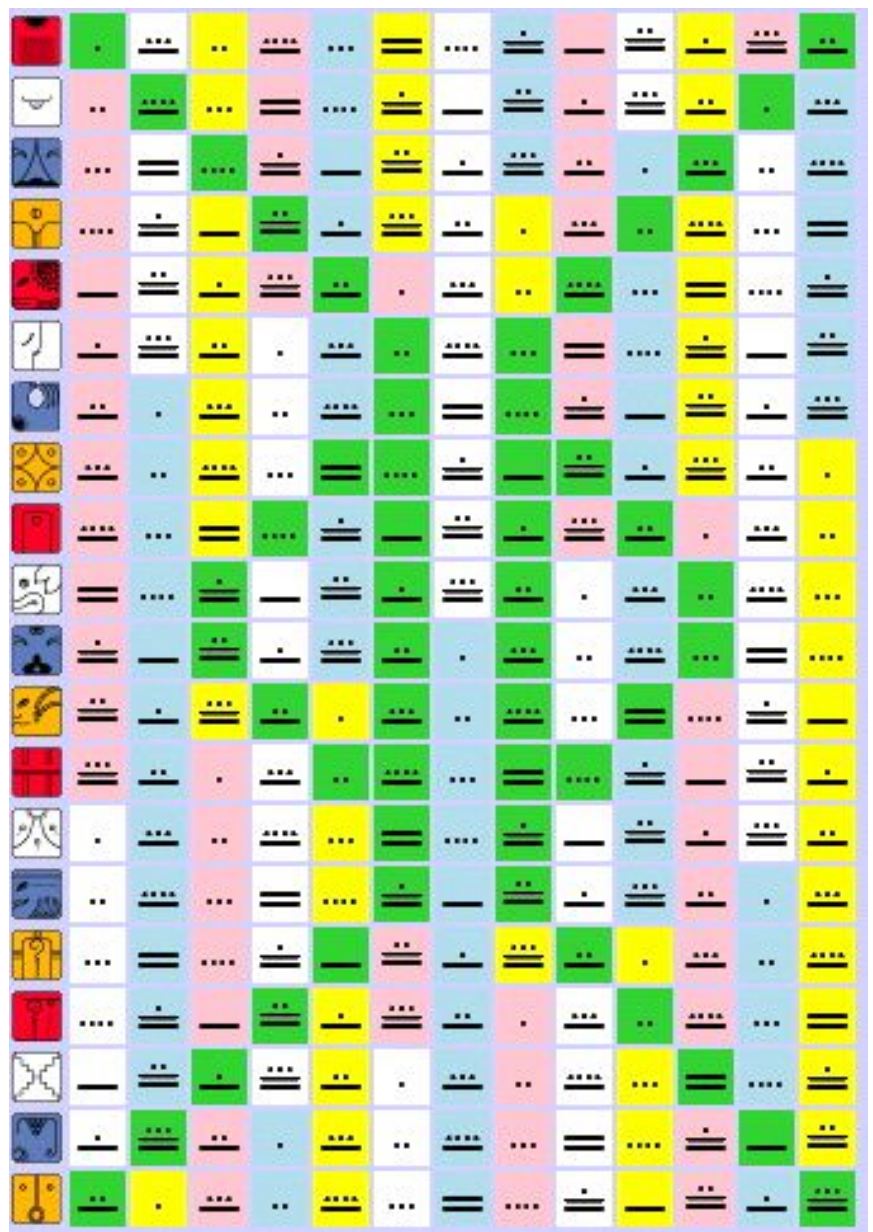
All bonding is PHASE LOCKING (waves dancing into perfect lock together). Later you will see this applies to both IONIC and COVALENT bonds when you study chemistry. The self-similar compression called AWARENESS or MIND has the role among waves - to MAKE THIS CENTERING FORCE. This is the “Substance of WE Feeling” so talked about in Sufi ( Doris Lessing’s books). Sending your emotion EMBEDDING down the SONG LINES - DREAMING TRACKS makes the stuff (the gravity Implosion GLUE) that holds them together. We should meditate on the role of Bliss made IMPLOSION in blood (DNA) in making gravity. This is necessary for scientists to understand or else they completely miss the role of genepools (like ours ) among stars. It is this ignorance that sets foolish genetic engineers to wasting kids souls by feeding them DNA that is dizzy. All DNA loses the skill to IMplode and make gravity when you put it in jail and make it mad. DNA is in prison in MONO-culture. This means - places where only ONE kind of seed grows. That DNA gets ANGRY - very mad. (Just like you would - in jail with only yourself). If you eat Angry DNA (most WHEAT - CORN & SOY today) (not set free) you get mucous, slime- and lose your immune system (your health). More on this soon in our hygiene section. (Hygiene means ways of living to stay healthy).

Genetic diversity - which means having lots of differences - makes DNA happy - because it sets it free to explore. (Same for you). HARMONIC INCLUSIVENESS (the presence of lots of different wave lengths) predicts vitality in EKG/Heart AND everything alive - because it is perfect in the Golden Ratio which starts compression into acceleration.

Happy DNA finds a way to squirt itself thru the Sun and get immortal. When you get super healthy and peaceful, you can feel the electrical charge field of your DNA start squirting up and out. By practicing - BLISS- you don’t have to wait till death to find out if your blood DNA field is going to make it into self steering COHERENCE. If you find sacred places (where charge is compressed into FRACTALS) - this gives your DNA field a better chance to make it into stars. Otherwise - you lose memory when you die. This is our immortality secret.

Now back- to mapping the Maya’s mapping of the Sun’s fire as the key to getting a soul (tornado in DNA) immortal:

The center of the Mayan Calendar (Jose Arguelles and so on) has the pattern of DNA.. and the pieces (‘codons’) of DNA - the ‘Trigrams’ triples of the I CHING - because BOTH are based on the PATTERN OF THE TIMING of the CALENDAR OF THE SUN! The Hunab KU stories of Maya - so made popular by Jose Arguelles - is another name for a symmetry ( set of turns) map to get your biologic CHARGE ( your ‘SOUL’) into stars. We use the sun as the sling shot - because it is the only local being with the Heart - inertia - to be a strong enough squirt gun. To a good Shem-an or vision person, the Eye of the Sun looks cool and





inviting and is an organ ( a tool ) of perception / of seeing. The Sun's heart is the only way to make it out of the solar system. Otherwise you are stuck here. ( Very UN-angel - like ). Visit the solar shamans egroup at Solar Heart Community in [yahoogroups.com](http://yahoogroups.com)

When Extra-terrestrials visit you - check to see if they came thru the sun. This means traveling inside only the field effect of their DNA. This way in here is called VAIRACHOCHA - meaning SUN GOD: those who came here thru the SUN. This is the reason AN - Antu the father of Enki & Enlil (Yalweh vs. Adonai, Michael vs Lucifer) as a word means SUN GOD (as Tuethe de Da-AN-an=Celtic&Iroquois means'People of the Gods') (again Enki's story at [goldenmean.info/enki](http://goldenmean.info/enki) )

On the other hand, if the extra terrestrials visiting you, arrived inside craft made of metal (NOT fractal or compressible) - suspect that they are LOW END - that is regard them suspiciously.

The ability to travel in this stylish way - is the result of effort to be supported by the hygiene of LIFE FORCE. (The 'Hygiene for BLISS'). LIFE's forces create successful connection between COMPRESSION in to ACCELERATION. Successful compression turned into acceleration in your blood DNA is definitely the KEY to BLISS and DEATH. So to prepare for BLISS and DEATH and RAPTURE is the same physical science. It involves choosing the discipline, the will, the shareability of learning that which can squeeze into ONENESS.

It just happens there is a simple physics and science which makes this teachable by measurement. ( Coherence as measured [heartcoherence.com](http://heartcoherence.com) & [goldenmean.info/coherence](http://goldenmean.info/coherence) ). This principle of compressibility suggests what to put in your mouth and your house and in your blood DNA. It IS the understanding of how to be supported by LIFE - by 'embedding' or nesting yourself into CHARGE dense (sacred) place.

Plus - blissfully - **this science is identical with understanding pure intention. The reason you do not buy a used car from a salesman whose eyes are shifty is because focus demonstrates the ability to locate what is shareable among waves. This is the role of mind among waves . This is why Golden Mean perfect compressible proportion defines both beauty, and focus, and perception, and COMPRESSION! This is why Golden Mean perfect compressible proportion is the absolute engine under the shape of blood DNA, Earth Grid and Zodiac.**

**If the shape of the electrical fields in the space around you is all messed up and chopped up - then you are going to have less bliss- ecstasy and enlightenment.** This means for example that whoever put ceiling fans in churches made a HUGE mistake. The magnetic field or waves from the motor and the metal blades churning makes scrambled mess of your prayers!

This kind of simple information is what our schools need in order to understand how their children can have bliss. By not knowing how bliss happens in science (electrically) - not only did the schools and hospitals not teach bliss - but they made large electrical environments where the waves of biology - CHARGE are so MESSED up (called ELECTRO-SMOG) that they actively PREVENT bliss - and of course the kids are sick.

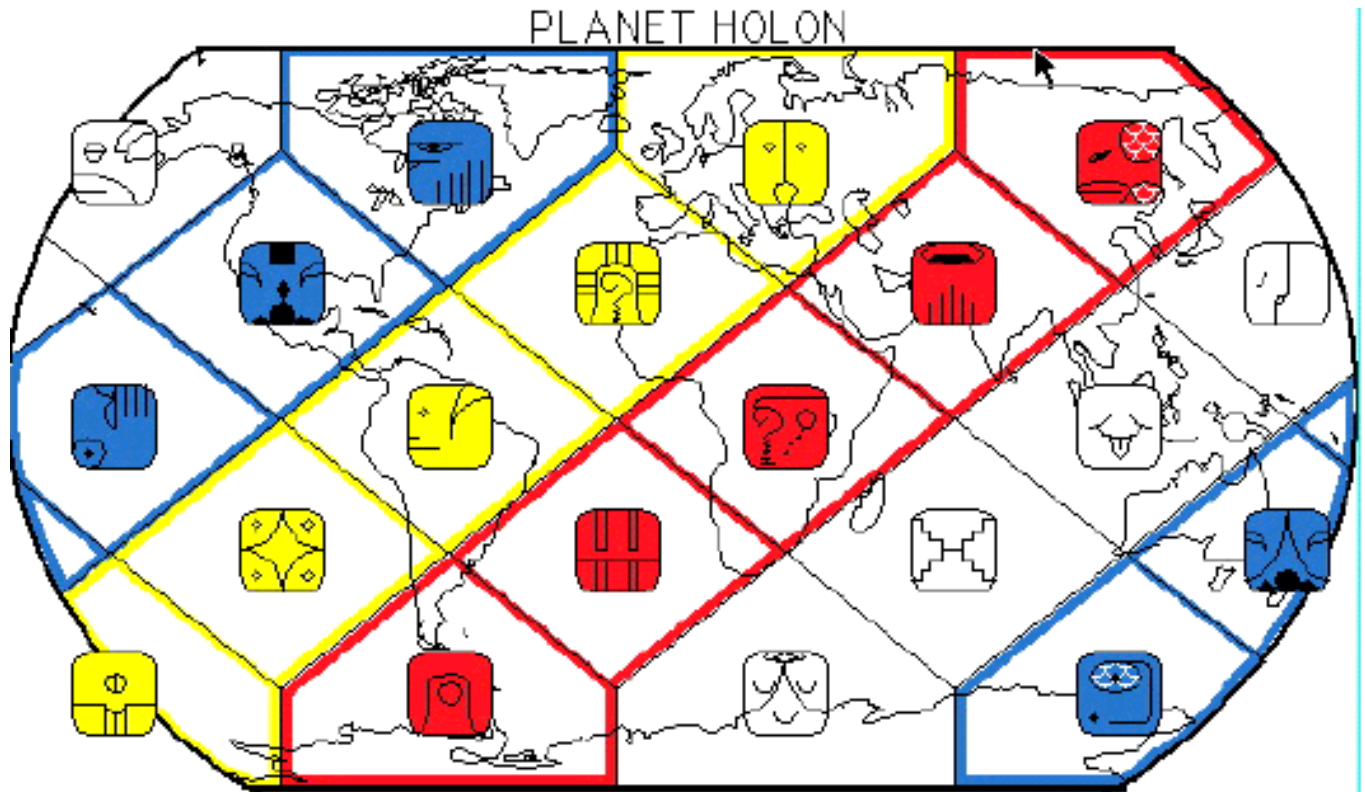
It is well known by doctors that in hospitals **healing does not happen without silence**- what they don't understand is the charge compression fusing (making into oneness) a standing wave - is what makes real inner stillness (Implosion) AND healing possible.

This is because - as we talked about- charge compressing into Implosion is nature's ultimate device to SORT anything (especially including the field effect of your health). This is because IMPLOSION is the ultimate FORM of COHERENCE.

If you would like to understand how fixing the environment and fixing the brain's music with a simple 'bio-feedback' game fixes ATTENTION DEFICIT without the nasty effects of RITALIN - see [goldenmean.info/ritalin](http://goldenmean.info/ritalin)

from Jose Arguelles work "Dreamspell" -

20 Indigenous root races form an icosahedron flowering around the Earth



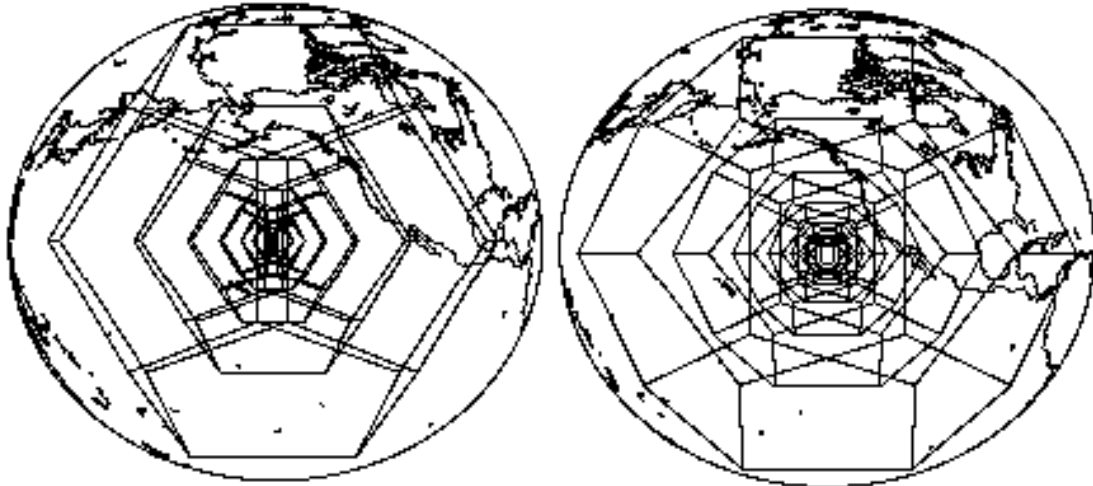
TIMESHIP EARTH  
2013

The indigenous peoples — root races — form a 20 faced icosahedron around the globe

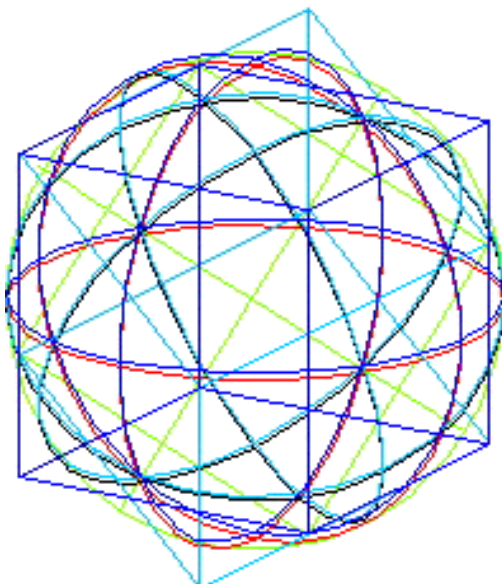


Touching slowly around the ringing bowl, sets up a ringing like the EarthWalk of the indigenous people. Pilgrimage is like caressing the standing wave around the bowl of the Earth.. braiding it to resonate in unison - with your own DNA- embedding in the whole. Imagine aborigines on Walk About.. ("The Song Lines" book-Bruce Chatwin)

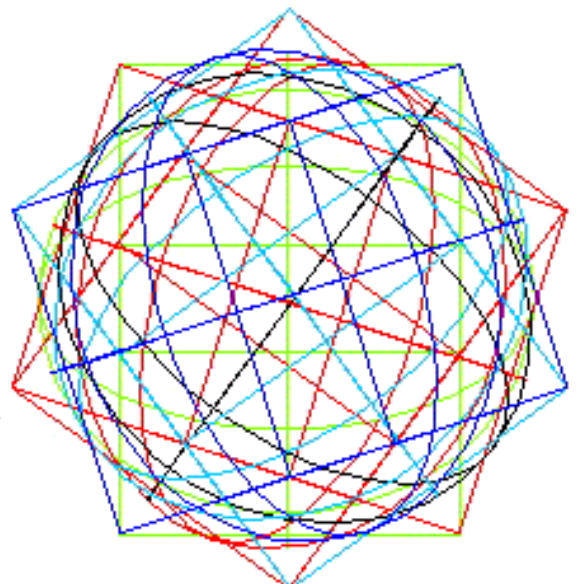




**CONSUME THESE PERSPECTIVES, MANY (PH)FACES-1 BODY.**



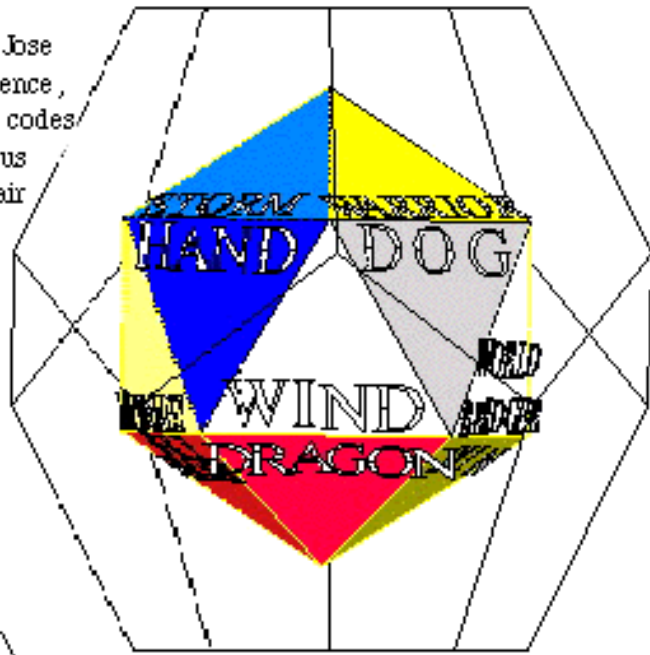
*Uroboros:  
The Serpent  
that Eats its Own Tail:  
like the continuous  
range of frequencies  
which make up sci-  
ence- from zero to  
infinite. Zero cycles  
and infinite cycle  
wavelengths  
are the same (where  
the mouth touches the  
tail): totally still AND  
everywhere at once!*



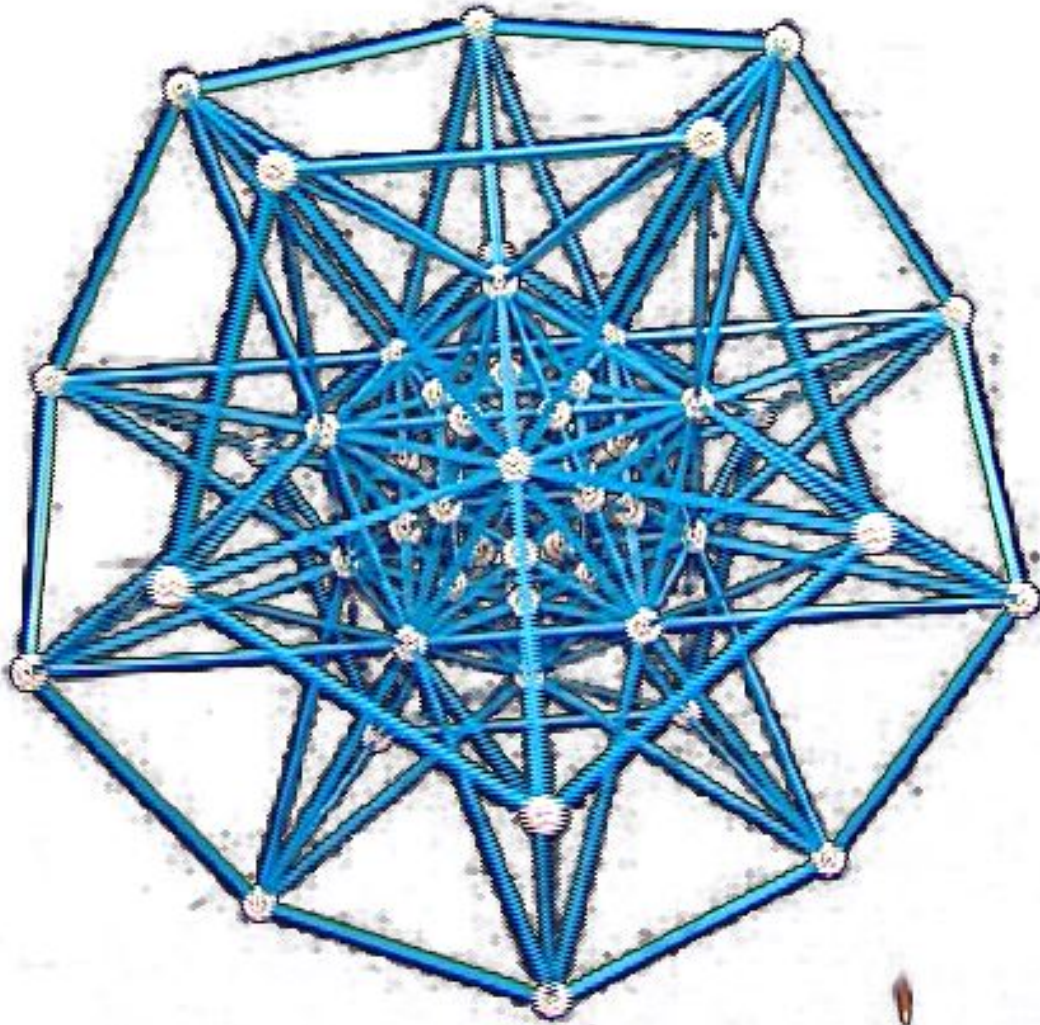
**Uroboros - 15 Great Circles in Symmetry - evolve a grid like Earth's into stable Gravity and holding atmosphere - by magnetic imploding. They are based on 3 spins around each of the 5 cubes in the DODECAHEDRON. By initiating proper (self similar) collapse - gravity is stabilized and atmosphere can repair. Just like cutting an energy line or a blood VEIN on the body- cutting meridians on the Earth causes bleeding ... of Charge & Life FORCE. Highway engineers who cut huge Earth magnetic lines without checking where they connect Earth's blood (magnetic lines)- receive biofeedback: their atmosphere disappears. When gravity is not stabilized by charge lines (dreaming tracks) arranged in a fractal - then air is not held to the planet.**

Then we have our good friend Jose Arguelles, a la Harmonic Convergence, pointing out that the ancient Maya codes for the distribution of the indigenous peoples around the globe IS (no fair guessing) ICOSA-DODECA!!??

20 tribes/ clans/ root  
races, 5 blue black,  
5 red, 5 yellow, 5 white..  
20 faces.. ICOSA/  
DODECA



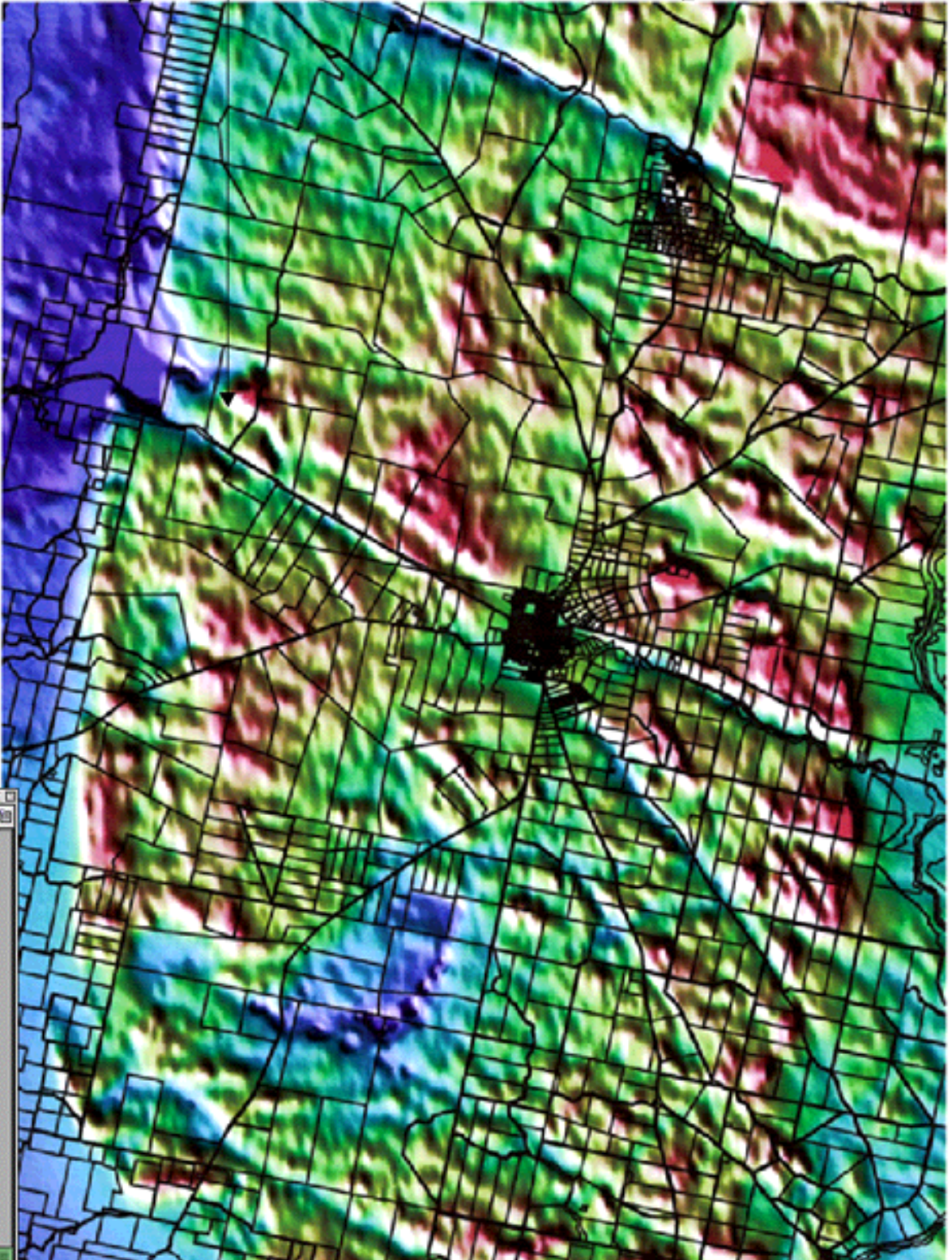
This is mostly symbolic-like the myth that Isreal had twelve tribes (dodec-icosa) which is the only way you can arrange charge elements in 3D symmetry to produce implosion. This is the real meaning why genetic diversity is required in correct symmetry to ignite DNA.



Star Mother Sacred Geometry Modeling Kit.. [goldenmean.info/kit](http://goldenmean.info/kit)  
also at [heartcoherence.com/starmother](http://heartcoherence.com/starmother) Teaches the 3D fractality of Dodecas nested in PHI-knit-ly.  
Like DNA - Earth Grid and Zodiac



Magnetic Flux Density Emission Map Reveals Population Centers Location & Minerals Water AND Songlines. "Rivers" OF Magnetism



Braidwood - Enhanced Magnetics

Rob Gourlay orbtek@anstar.net.com.au

Braidwood Geoprobe Club Enhanced Magnetics  
 Map prepared by Natural Resource  
 Intelligence Pty Ltd (NRI)  
 February 2005, using TRIMpe (05)



Take also for example, the 'fluorescent' light in children's classrooms. The waves coming from that light are out of harmony (called "out of PHASE") with the Sun.

Understanding this - now helps us define EVIL as scientists. (George Bush take a lesson) - **Evil means waves which fail to nest or embed. ( Out of phase or 'tilt' angle with the SUN and FUSION / IMPLOSION ) . This predicts their death - because being non-shareable - they will be self cancelled.**

This is why **taking out 'evil' fluorescent lights and putting in sunlight to class, immediately helps repair - "ATTENTION" span** (how long you can focus). The reason is that the **waves coming from the Sun have the musical recipe for make FUSION. This is perfect collapse and compression for waves. This FUSION for waves called IMPLOSION (the opposite of explosion) is the PRINCIPLE of what the Sun is made of. AND this rule or principle for how waves FUSE or come together perfectly - is ALSO the musical recipe for ATTENTION!** (Later when you study more science check why Golden Mean is the ratio in the Balmer series of Hydrogen's waves - the heart of fusion- and the SUN).

Extending this way to attract waves of CHARGE (fusion and implosion) - to its completeness - is exactly BLISS / ENLIGHTENMENT. When waves of CHARGE get used to being sucked in to one center (IMPLoding) so that it keeps on going+becomes self organizing - this brings the information in those waves. **THIS IS WHY BLISS IS THE ULTIMATE AND FINAL PHASE OF EDUCATION - BECAUSE the CHARGE IMPLOSION called BLISS IS THE ULTIMATE -the perfect - source of biological information - EDUCATOR!**

**Imagine sometimes when you are very relaxed on a big quiet stone or under a big quiet tree.. and after a bit you notice that the pictures you begin to see or hear inside your head get clearer or louder. This is because the electrical charge field or 'spirit' has found a way to distribute it's information LOVINGLY into you! This is what is called - allowing yourself to be supported by LIFE.**

**If you do not spend time often in quiet in nature - then you miss all this opportunity. If you continue foolishly avoiding nature's offer to pour life giving information ( CHARGE) into your body - then you begin to lose your soul- and die quicker. This is similar to the millions of people who never leave their stupid big cities where all the magnetism is dizzy. Soon they are actually walking around dizzy and in a kind of 'shock'. They forget even the possibility that bliss and charge communion with life EXISTS! Spending time often barefoot in nature and quiet (wet helps too) is a great way to keep electrically grounded into this INner NET.**

You see that the shape of these waves of charge from biology are the ultimate or perfected form taken by all biological information. They are what shapes your cells and your body and your life - so **the function of education is to build life charge - and NOT the other way around.** Once you have a way to your own source of biology's CHARGE - imploding BLISS from inside- you become the source and the fountain of information. **The only reason to use books and school and computers after that is to perfect the LANGUAGE in which to express the beauty of what you have already seen and heard and felt inside.**

**The best and only sustaining language in which to express BLISS & biologic immortality - is PURE SYMMETRY. Remember our origin of the Alphabet pictures & <http://spirals.eternite.com> This symmetry of tilt angle of fields of charge - called ALPHABET - is the only language possible for life.**

People who have not had bliss - are often saying not nice things about those who use bliss as their source of info. BUT - all of those people whose eyes do not twinkle from bliss- still tell stories about how nice it would be to be Einstein or Jesus. And yet the only reason to admire heroes - is to learn how they got to BLISS - because that is where their inspiration came from. So save yourself the time loss of worshipping personalities and go right to the PRINCIPLE and the RULES. These are what help you to bliss - you become the source:

**THE BURNING FOUNTAIN.**



Unifying Nations by Unifying the LANGUAGE OF SPIRIT-

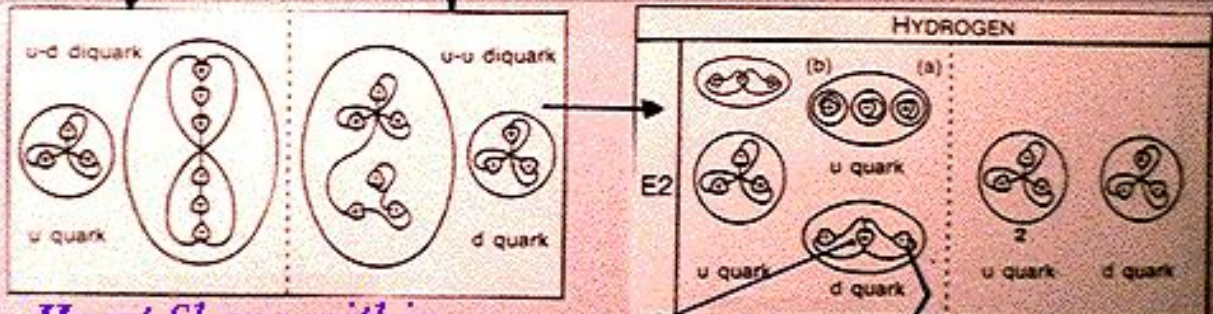
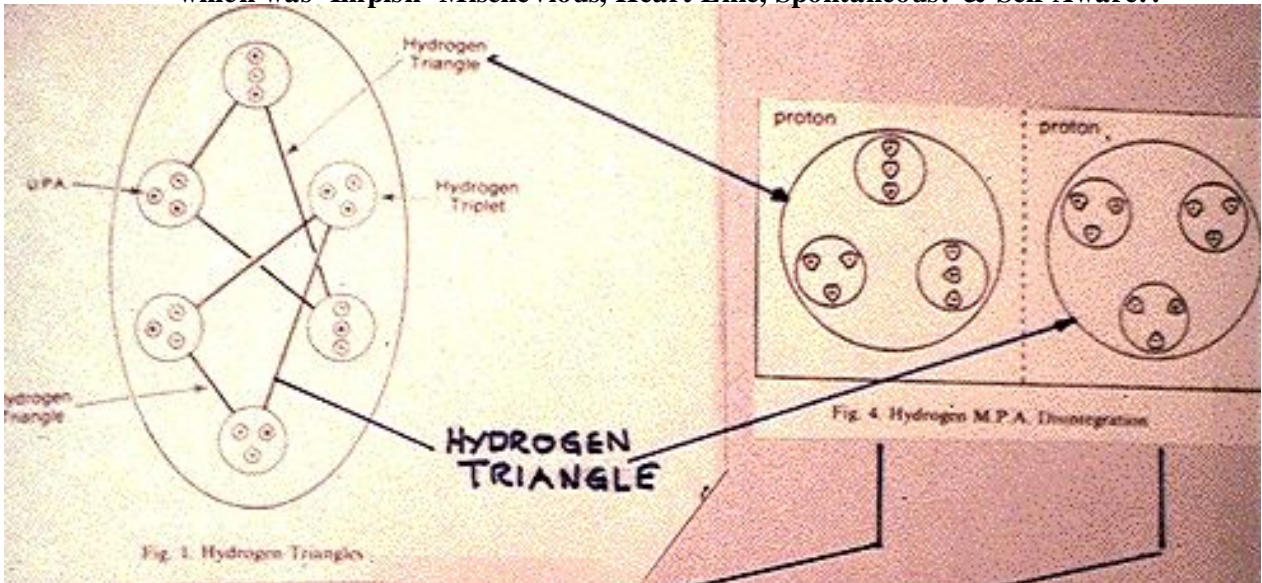
The ANU - "Ultimate Physical Atom" compared to the Quark - compared to the idea of Particle of LIFE (called Microvita in Ananda Marga). article at goldenmean.info/namesforspirit

Orgone, Barrakah, Chi, Shaktipot, Eck, Microvita, Grace, Ectoplasm, Automata.. How Many Words Do We Need for ONEness?

If the children are caught in a linguistic tower of babel - failing to teach them THE PRINCIPLE of LIFE FORCE - how can they ever make life force and teach peacemaking as science - in their world?

Why Spiritual Language is more ATTRACTIVE using SCIENCE ...AND why Scientific Language is More Attractive using SPIRIT - Charge Compression to Teach LIFE! ``

When the clairvoyants saw the ANU predict the Quark - their pictures showed a little flaming slip knot which was 'Impish' Mischevious, Heart Like, Spontaneous? & Self Aware!?



Heart Shape within Heart Shape (+)

(+)

(-)

KEY 202 - DECA-DELTA - ETHERIC 1



TRINITY  
"7" RAYS  
7 spins outside

5 spins inside

2 'Chiral' or Mirror Forms

## How does bliss - 'the burning fountain' - 'the fire that does not consume' - help end parasites?

Do you know what a parasite is? It is something that starts eating away at you in some way, and does not pay back anything. An example of a parasite is someone who keeps telling you that 'God is outside you', and 'you cannot understand for yourself so worship miracles'. This prevents you from **taking responsibility** and therefore bleeds your power and life. If you now come to understand that what you called GOD - is the principle of creation - how to attract and compress charge into creating - THEN GOD IS INSIDE YOU. (inside your heart and head when you learn to implode and make bliss / charge from inside). At that moment your aura - your bubble - your HALO - your CHARGE COCOON - becomes SELF STEERING. This means that you make your own decisions - and you take responsibility for your life.

The reason also that BLISS ends parasites- is that low grade blood (DNA ) gets toasted and dies in the presence of IMPLOSION (bliss). This is why vampires die in sunlight. So if you have FIRE - BLISS in your heart - you will quickly find how fast parasites leave your body and your aura! This is also why 'friends' who are really parasites will soon leave your aura if you really radiate joy and bliss. As you experiment with what keeps this fire inside you - you will discover the real meaning of LIFE. For example - if you eat food that is not ALIVE (too much cooked and processed food) - this will attract PARASITES TO YOUR STOMACH. You need these parasites in order to eat the death out of you. You can learn the most about a body by studying its parasites. (Shooting the bug or bacteria is not always the same as learning its lesson - don't shoot the messenger). So this brings us nicely to our PRACTICAL instructions for BLISS.

Let's start with DIET - what you put in your BODY.

The first principle of diet (food) for bliss is that it takes LIFE FORCE to make LIFE FORCE.

You see, **every single wave** (and 'molecule' and 'atom' - the little things which make up the world according to science) - **when it becomes part of LIFE gets re-arranged so as to be FRACTAL**. This means that the shape inside is re-woven (braided) to become more rose or pine cone like.

Roses and pine cones are perfect examples of FRACTALS - the idea is called being SELF SIMILAR. This simply means the inside looks like the outside. When waves of charge get FRACTAL like this they compress perfectly and therefore allow charge to go in and out of implosion - speeding up at center. The overall **information connecting thru light speed of CHARGE by implosion (attracting charge) is called LIFE!**

We can measure this because **things that are alive attract electrical charge from within** ([goldenmean.info/biophoton](http://goldenmean.info/biophoton)).

LIFE itself is another way of talking about the infinite communication based on Golden mean that happens between waves when they compress perfectly into IMPLOSION FUSION. In Science this is sometimes called "Infinite Multiply Connected TOPOLOGY". This just means - how many different folds on surface can converge or compress into one wave or fold at one place. **LIFE IS where the MOST WAVES TOUCH!**

We can now make a definition and meaning for the term ORGANIC. This is good, because the word is getting too vague for use in the grocery store. **Organic is a name for the ability of biology to attract charge when the electrical SYMMETRY (pattern inside) is more FRACTAL**. When waves of charge nest inside each other very nicely, then the CHARGE does not bleed. If you could put your food inside a good biology CAPACITOR like a PINE CONE - or EGG - then it would keep longer. Putting your food inside a refrigerator has a serious problem. **Refrigerators made of square shape, and metal are TERRIBLE leaking capacitors. This is why your food loses life so fast inside**. Refrigerator designers are almost as stupid as city designers - who use too much metal and square shapes - in letting people use leaking charge for their space to be.

You could make a lot of money by making refrigerators that are better holders of CHARGE. This is what a scientist named REICH meant by ORGONE! People kept inventing new words like SPIRIT and CHI and ORGONE and MICROVITA and BARRAKAH because they did not know what a capacitor is or how they communicate ( it is faster than light!). Life uses this faster than light way that capacitors communicate and we call it telepathy and spiritual healing. We have measured the way trees do this - using capacitors.



goldenmean.info/biophoton

We should talk more about how **making houses and buildings into holders of CHARGE is absolutely necessary to holding BLISS and LIFE. This creates new meaning for success & the word SACRED in ARCHITECTURE.**

( goldenmean.info/architecture ).

In order to understand for yourself - the meaning of the word ORGANIC a bit more - let us consider how waves of charge can be shared or distributed perfectly. (since this is how life works).

Waves of charge are wrapped in little nests of wave packages called ENVELOPES of waves. When an envelope of waves hits you, you call it a particle or matter. But matter and particles are only named for the INERTIA of these rotating spinning 'envelopes' made of waves. (Just waves of compression moving about in something you could imagine as a universal smoke or even jello - sometimes called ETHER. Nice book: NOTHING BUT MOTION - by Dewey Larson). This is important, because eventually YOU are going to be able to steer waves (tornadoes, wormholes, and everything in science) by understanding this. We call this "Adopt a Pet Tornado" - you are A.P.T. to like it.



Remember- **HOW TO STEER A TORNADO as a Shaman or priest - is how to steer everything! Feel compassion for the anger (the spin that does not fit the nest), electrically sucks you in to the center (of gravity) of the tornado.** ( More pictures & story at goldenmean.info/dowsing )

--

So let's get back to the question of what shapes make perfect LIFE FORCE in principle. Imagine you were sitting there looking at the perfect head of broccoli or cauliflower - and you thought to yourself- hey- that look's fractal!

**PICTURE OF CAULI-FLOWER as FRACTAL:**

**Distributing waves of LIFE FORCE (which is what consciousness as in CONSCIOUS KIDS is made of) - is like sharing touch. Waves that can share touch without hurting each other - or losing inertia or motion - can be distributed forever.**

Remember in the movie '2001' where Dave touches a monument on Mars and finds he is distributed everywhere at once? Well there is a science to this.

This science is called: **Inf-nite Distribution has NO Storage.**



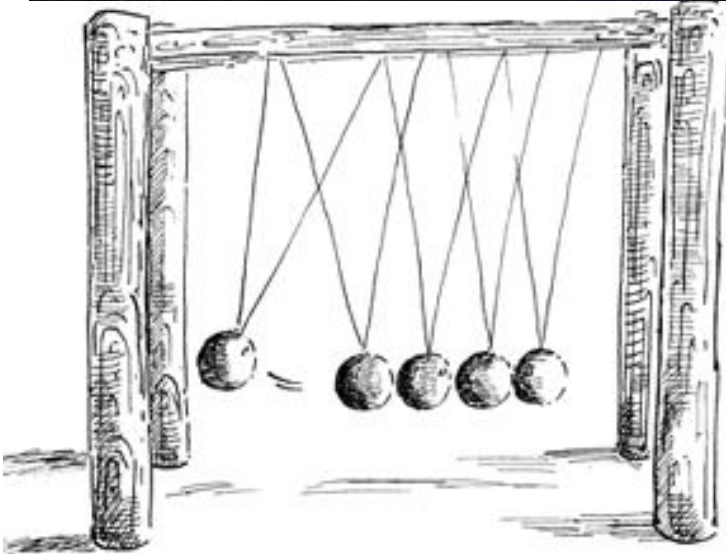
There is a famous book said to be by Christ and Einstein (Primer on Energy - Primer on Rotation) which says something like: **ALL HUMAN WANT AND LACK or SCARCITY - COMES FROM THE ATTEMPT TO STORE RATHER THAN DISTRIBUTE.** This is particularly true of spiritual information and bio-logic immortality. There is one symmetry or pattern which will allow **PERFECT INFINITE DISTRIBUTION** with **ZERO STORAGE.** (This **SHOULD** be applied to spiritual business).

Picture this..



Suppose you had a row of billiard balls - lined up from here to the moon. If there was a tiny gap between each ball - then when you bounced one ball into this end- it would take a **VERY** long time before exactly **ONE** ball bounced off at the moon. And if the space between each ball was not tiny enough ... the **INERTIA** of the ball you hit into this end - would **NEVER** reach the moon!

Now - suppose you re-arranged that long line or chain of balls. Let us now put them so that every ball precisely **TOUCHES** the ball next to it. There are no spaces between balls. **NOW-** in your imagination - bounce **ONE** ball into this end of the row which goes to the moon. Sure enough - exactly **ONE** ball bounces off the chain at the moon - **AND this happens FASTER than the speed of light - AND - there is absolutely no INERTIA (motion) lost on the way! And yet - every single ball on the way - has FULLY FELT and been informed of ALL the INERTIA / memory (information) which passed thru them.**



Now - imagine you are a network of waves of charge- and you want to breath into them in this way. This charge being breathed into you network is called **LIFE** and is the root of the word to **AN**-imate. (The word **AN** comes from the Sumerian Extra Terrestrial **REAL** star trek story -goldenmean.info/enki).

See- the thing is that **life can happen if waves of charge can constantly be fed back to center. This is why to SELF-REFER is the definition of LIFE in ancient Veda. Golden Mean Ratio is the per-**

**fect way for waves to self refer and create awareness because: (picture on p.51)**

1. **this is the only angle at which a wave can enter ITSELF (self re-enter) - without hurting itself.**
  2. **this is the perfect way for to compress infinitely (fractality is perfect with Golden Mean). Charge compression and information compression are the same.**
- So fractality is the perfect distribution system for wave information just BECAUSE it is the perfect compression system (way to make a center = to dimple and MAKE HEART!).**

-See Picture next page - **EMBEDDING or Perfect Nesting as Heart of Matter, Path with Heart.**

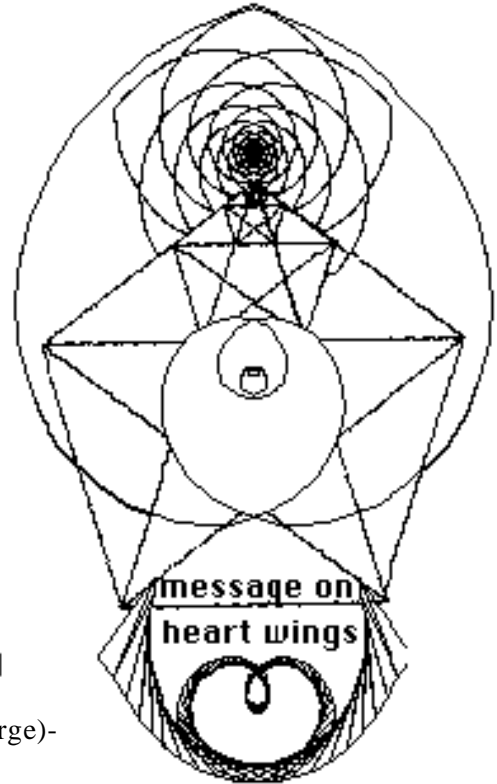
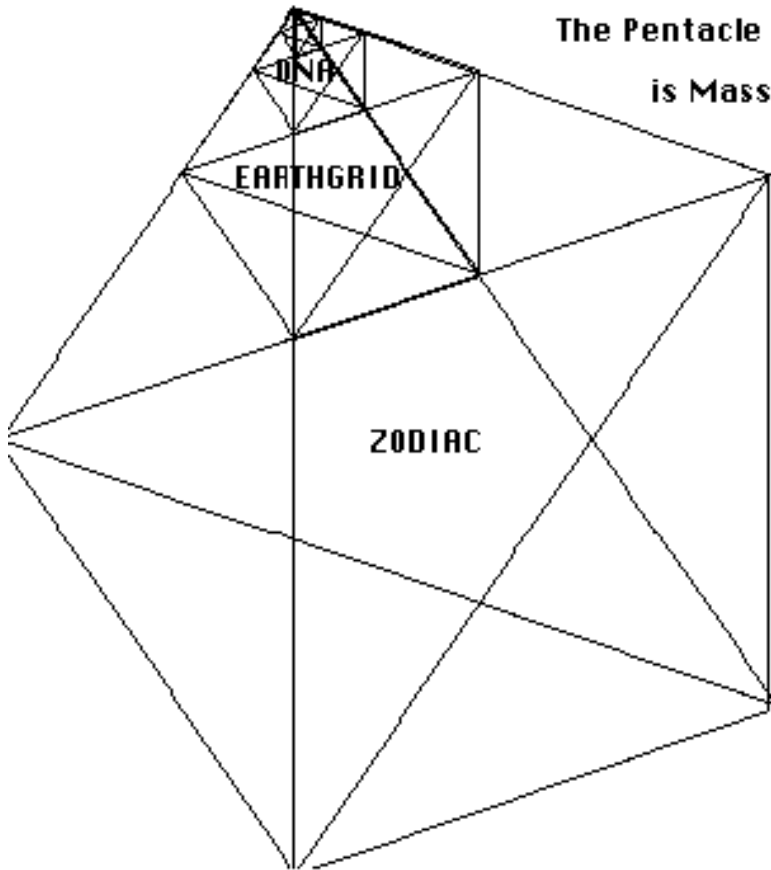
So now - you can see why it is important for you to be able to **enter the heart of a fractal - if you want to be able to extend your feeling (your waves of charge) forever.**

Let's give a practical example. The book *Celestine Prophecy* was one of the first to say: **ALL HUMAN INTER-**



**The Pentacle Dodecanest Fractal Harmonic Series**

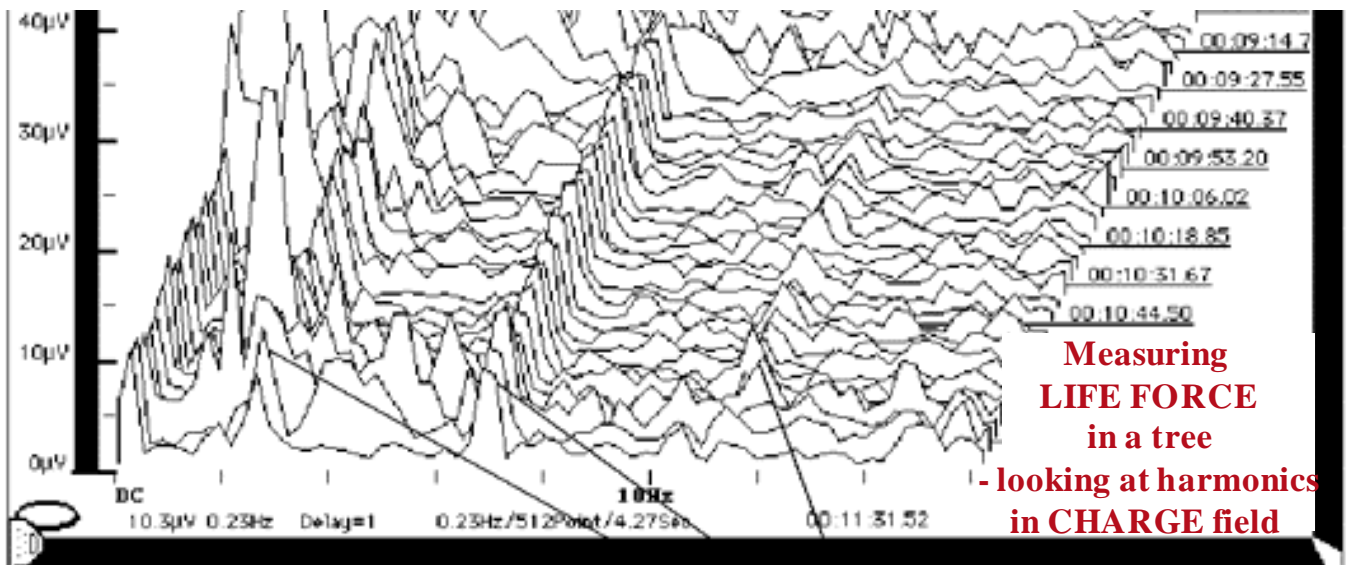
**is Massaged to Life like Ariadne's umbilical Cord, by the Frequency Signature of the Heartbeat, in the Moment of Love.**



**DNA, Earthgrid, and Zodiac are Dodecahedra, their Common "Golden Mean" transmission call letter, is the Merkabbah Vehicle linking them.**

MerKAbah=Mark or Vehicle (KA)of Pressure (Charge)- see goldenmean.info/merkabbah

**ACTION IS ABOUT CHARGE.** Now we now that **LIFE FORCE IS THE ABILITY TO ATTRACT - SELF ORGANIZE - and COMPRESS THIS CHARGE.** Well also in that book they tell the story: The best place to go if you want to see aura's (glow / charge) is to sit under a OLD GROWTH (means very old original) TREE. The ability to see AURA's - which are the charge radiating coherently around people is called CLAIRVOYANCE. So - if you would like to help your CLAIRVOYANCE - get peaceful under a magic old tree!



Tree ELF Magnetics. Approx 2.7 hz, 7hz, 11hz. As Callahan reported, Earth "Heartbeat" Schumann

Harmonics measured ringing in the Extra Lo Frequency (ELF) Magnetic Harmonics of an very old tree- RESPONDING DIRECTLY to human emotion- sending love! Same frequency band of brainwaves (0-15 hz).

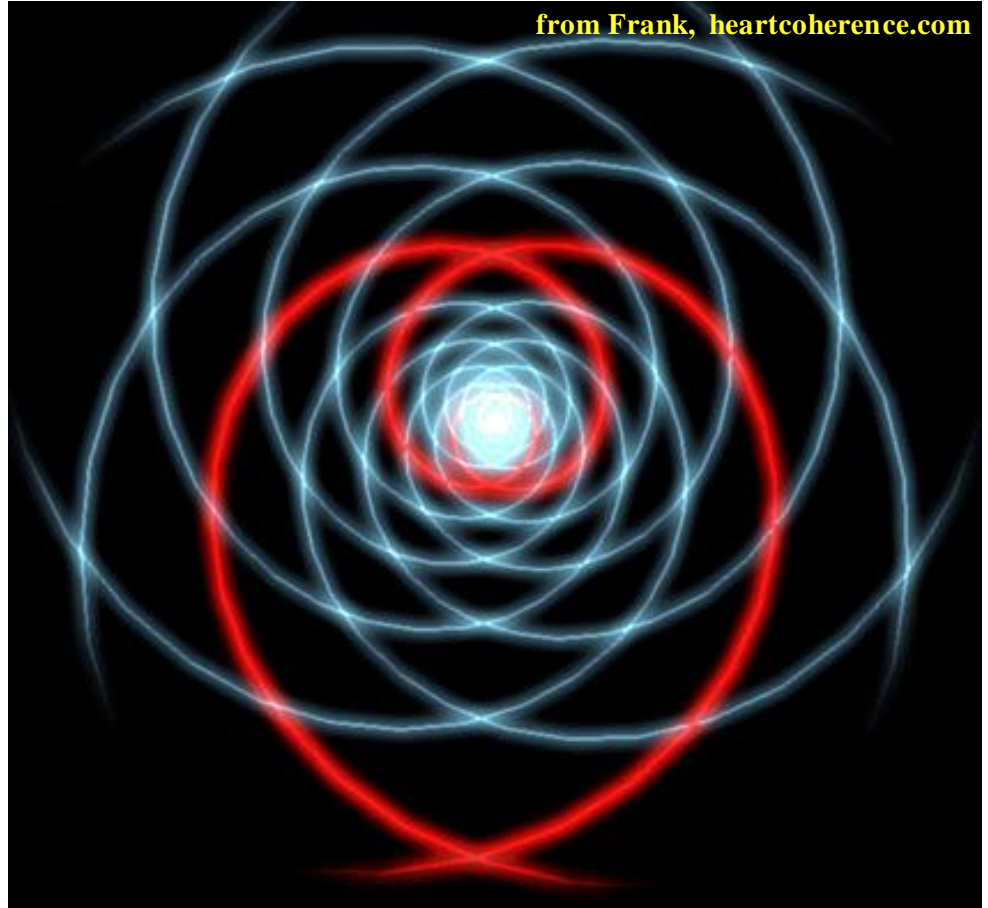
In this case the response is to a Native Tradition inspired prayer. (Capacitive probe:hemp fibres-brainwave preamp.)

But now - we need to know the SCIENCE of this in order to be self emPOWERed. The tree has a branching whose pattern is called **PHOTOTAXIS**. This is based on GOLDEN MEAN.. This is MAXIMUM EXPOSURE MINIMUM SUPERPOSITION .. It means - the best way to SHARE.... the light. The principle of this perfect branching is where we get our world DI-VINE - which means branched perfectly. If your waves of charge can branch perfectly, it is JUST DIVINE!

Perfect branching as you see is based on Golden Mean ratio. Nesting things in 5 sided PENTagrams creates GOLDEN MEAN. This is the reason why almost all living shapes are FIVE sided. (Like the top down view into your blood's DNA).

Now we need to know HOW this branching is created to allow the breath of life (CHARGE) to move infinitely ONLY thru fractal shapes.

Here is how it works. When something alive..needs to add a molecule or particle to itself - it must do so in such a way as to keep it connected well to all it's bio-logic information. In order to make this inside multiple connection ongoing - mother BIOLOGY rearranges EVERYTHING SHE CAN LIVE WITH into FRACTAL SYMMETRY. So the molecules of anything that once becomes involved with LIFE -



get themselves re-steered into FRACTAL or SELF-Similar design. This is well branched or divine. This re-arranging of the pattern of electrical centers inside your food - is the definition of the word ORGANIC! In fact - everything alive is re-arranged to become efficiently part of charge compression - just in order that waves of charge can efficiently breathe in and out of their center.

This is similar to a concept we will study below - when we talk about Feng Shui or the shape of your back yard - to allow Spirit. **Stones like LIMESTONE - (similar to biologic ORGANICS) that pass on waves of charge like a focusing LENS - these are called PARA-magnetic.** Stones (like sandstone) which break up lines of magnetism into little pieces like a sieve or strainer- these are called DI-magnetic stones. Paramagnetic stone makes sacred space because the lens like function makes permission to touch for ordered waves (no destructive interfering). This is different that DI-magnetic stones which FRACTIONATE (break up) instead of make FRACTAL (life).

**FEELING your Pet Rock?** The reason that limestone (calc) passes magnetism into focus like a lens - is that it is made of sea creatures skeletons. This means that all the particles and molecules have at one time been part of biology. This means that the collected shape of the particles inside will all be more fractal - and breath with the compression to center of charge called life- better!

Once biology gets her magnetism into the only possible 3 dimensional fractal - a perfect bubble - the particles don't need to move much - (like the billiard balls) and still can breathe with perfect charge going in and out of the implosion (life center). Locking each little wave center into this arrangement with perfect efficiency - starts infinitely fast charge sharing creating infinite numbers of waves that can share the same center. (Like billiard balls in an arrow out each symmetry of the Dodec).



Extending the idea of nested 5 sided PENTagrams into 3 dimensions - we get nested **DODECA-hedron**. (DO means 2, DECA means 10, dodeca has  $2+10=12$  points or vertex, 2 time 10 = 20 faces - remember- HEDRON means faces).

This 'DODECA- NEST' creates the top down view of DNA in your blood, and the Earth Grid and the Zodiac. Mother nature uses this fractality to allow the breathing of charge (AN-imation) in and out of compression center - re-cursively. (Re-cursive means to re-cur = to keep going back and repeating in a little loop). So... presto ... now you UNDERSTAND why every time you chop something up -it starts BLEEDING this wonderful CHARGE compression ... and that's how Death is started. Again: fractality (perfect compression) creates LIFE... versus fractionation (breaking things up into too many pieces) creates death. How simple! Now you can understand how the waves of charge in capacitors measuring gravity (like TREES) can move faster than the speed of light - and create the science behind astrology. (see picture of capacitors & trees talking faster than the speed of light P 64. ) The geometry in Astrology is the charge or 'spirit' waves which cascade down the tunnel thru light speed - causing gravity by their suction (implosion).

--

So - you have seen how wise it is to get organic energy and life force inside your body. This allows you and the charge inside you to breathe -with the life giving perfect efficiency of fractally perfect charge distribution. We MUST learn to recognize CHARGE compression (density) so that we can intuitively pick up the RIGHT piece of food every time we have the choice. Because if we cannot DIRECTLY FEEL THE CHARGE OF LIFE - we will never be able to make our own decisions about what to eat! (then BLISS will miss us)

--

#### **How to FEEL the charge of life:**

First, try placing your intention with careful peaceful focus entirely inside your right baby finger tip. Keep your attention there until your baby finger tip begins to TINGLE and GLOW and get WARMER.

Good- then try to be aware that it was *the electrically real FORCE of your ATTENTION which caused your finger tip to begin to glow*. This is the kind of direction of the electrical centering force of your attention which could help you become a healer. The thing to understand for this moment - is that the same charge compression caused by the imploding centering of electrical waves from your nerves - which made your finger TINGLE - is the exact science of gravity making which will eventually let your make tornados and stars move. If you focus your emotion with enough coherent intention (charge)- then you can transform your food your clothes and even your environment. Eventually- a million children singing effects the SUN!

--

**So what we are about to do now, is use all the things we have learned about successfully compressing these waves of charge (called 'Spirit' / spiral - it).. to creating a way of living to always invite in BLISS (charge) into our bodies.**

**Let us ( just for the purpose of study) - divide the SCIENCE of BLISS in life - into 4 Chapters.**

- 1. Bliss in diet - food and drink.**
- 2. Bliss in movement and dance - called 'kinesthetic' - just think of yoga and tai chi and so on.**
- 3. Bliss in the shape of the things you have in your house and school. This arranging your environment to be fractal - is the SCIENCE behind FENG SHUI.. create BLISS in your CHARGE SPACE.**
- & 4. Rites of Passage, Initiation and Group Bliss.**

When you bite into a whole apple - you feel a strong wave of TINGLE thru your cheek. If you chop up that apple first into tiny pieces with a metal knife- then all the charge BLEEDS AWAY before you eat it. So when you put the apple sauce - particularly if you heated it too much - into your mouth - THEN YOU FEEL NO TINGLE. You probably knew this before. But never thought about it. The REAL sadness is- that up til now - no one explained to you THAT IT IS THIS TINGLE THAT IS THE FOOD!!! Eating the apple with no tingle is almost useless - because it is the CHARGE that feeds you.

This principle about WHOLE - NESS (called em-BED-ding meaning to nest well into the WHOLE) - as opposed to CHOPPING UP .. is called FRACTALITY (wholeness -well em-BED-ded) versus FRACTION-ATION. Every single time someone leaves your food cooking or in the blender too long, (or worse- the microwave) the particles (molecules) get all scrambled up. When this happens the 'capacity' to hold CHARGE bleeds away. SO THE LIFE BLEEDS AWAY. So -it is simple - avoid too much chopping or cooking whenever you can.

First - we would like to introduce you to our friend Guy Bennett, a Kinesiology (healer) instructor from Brisbane. We became fascinated with Guy as he told us many stories of being in India with his spiritual teacher. This teacher was confirmed by many witnesses to be around 1000 years old! And he did not look old. Guy says that when he goes into the shower he does some prayer or other, and comes out with any grey hairs disappeared!

Guy was on his way back to India to work with his teacher, who appreciates some privacy - but he DID send us this letter about his meditations on IMMORTALITY: (quoting now)

“The other day Dan and Valerie asked me to write about immortality. I had the opportunity to meet someone who has maintained his physical presence for the equivalent of many normal life times. When asked about this he would reply “it is just a science”.

As a small child the notion of death seemed strange. The idea that people must die seemed like a bit of a negative spin on a life that was for the most part lots of fun. I didn't want to die; I didn't want my parents to die either.

Many years later in my mid 20's I was introduced to the idea of immortal masters that continued to look young. This sparked something very deep inside myself, I began to read books on the immortal ones I instantly believed it to be true even though so many people thought I was a little crazy. My logic was: – *I do not remember having died, I have no direct experience of it in my own living memory. Therefore, just because other people die, why should I automatically assume that it must happen to me?*

Some people said that we can re-incarnate anyway, my response to that was: - *it has been such a hassle being born, wearing nappies for years, going to school etc. before we get a chance to address the issues from past lives. Wouldn't it make more sense to clear our issues in the one life time without having to go through the ordeal of birth time and again?*

People said that it is impossible to live forever. *Impossible* is a strong word. Having a genetics background I am aware that our sex cells (germ cells) i.e. sperm and ova, come from us to form new life, the new life produces sex cells which then goes on to produce another new life and so on, there is the potential cellular immortality from generation to generation. It is quite likely that the cells in our body are pre-programmed to decay after a finite time or number of replications and this is what ultimately kills us. What we are talking about is programming at the genetic level. Why can't we turn the programming off, how can we say it is *impossible* if we haven't researched the possibilities. They said it was impossible for a man to fly, to go to the moon etc., genetics is a young science which is growing all the time. However does this science already exist, are there people who walk the planet already capable of life extension and perpetuating youth? Legend and myth in certain cultures describes such beings, fortunately for me it is not a myth, I have witnessed it with my own eyes, I know this as fact.



If science does come up with away of reprogramming the genes to allow for unlimited life extension, what are the likely re-percussions on an overcrowded world? Hmmm perhaps we should only give it to the politicians, wouldn't that make the world a better place, or maybe make it really expensive so that only the filthy rich can afford it. What a boon for the world it would be.

In ancient china there were two classes of alchemists, the ones that worked with potions and the ones that worked internally. They both sort immortality. The internal alchemists where experientially involved in there journey through writing poetry, observing the patterns of nature, practicing meditation and Qi gong. The external alchemists projected there process into the potions they concocted, often being poisoned by them. The potions that they made could theoretically be ingested by anyone to give them immortality.

The hygiene (to use Dan's terminology) of immortality in my understanding requires the highest level of coherence. A perpetuating body requires such a high fidelity with the unifying principle. The individual is continually self-organizing into a configuration that transcends decay and time. Interestingly these individuals are not confined spatially either, being able to dematerialize and rematerialize to different locations and dimensions, they can also be in more than one place at the same time.

*Auto Biography of a Yogi* by Paramahansa Yogananda described the three states of self realization, the highest level is attributed to a perpetuating body with the power of resurrection and ascension (like Christ). It talks about the three planes: - physical, astral and causal. Each of these planes is more refined and above the causal is *pure God consciousness*. Once *pure God consciousness* is reached individuals may have these powers.

Within some organizations, religions and scientific practices that seek immortality (or some kind of permanent continuity of existence), immortality is misinterpreted. It is not an end in itself but rather the side product of a journey into the divine. To seek immortality for the sake of immortality is an ego driven process. The ego seeking to propagate itself forever is *hell not immortality*. Death serves a function, to release a soul from a crystallizing ego that is impeding the soul's evolution. When the ego is diminished to an extent as not to impede the soul's evolution nor impede the service it provides to others then there is no need to drop the body, the *hygiene* of immortality is attained.

The ego seeks to survive but at the same time it sees itself as separate from everything else, the truth is that we are all part of a unifying principle. Therefore the desire for survival based on separateness is flawed and as a consequence this disrupts the inherent coherence of the living system impeding growth and setting up the conditions for decay. That which is driving our survival is that which ultimately blocks it.

Life and the universe goes on regardless of our individual existence, we are like waves on the ocean of life with no real independent existence from the ocean that we arose from. If conditions are such that the wave continues to perpetuate or such that we dissolve back into the great body of water, we are still the ocean nothing is lost.

Golden master strand

Coiled and quiet

Floating in a night of icy mind,

Given with Gods first breath

Beyond the whim of birth and death

Waiting without time,

A seed within a seed

A father within a son

A sacred subtle signature

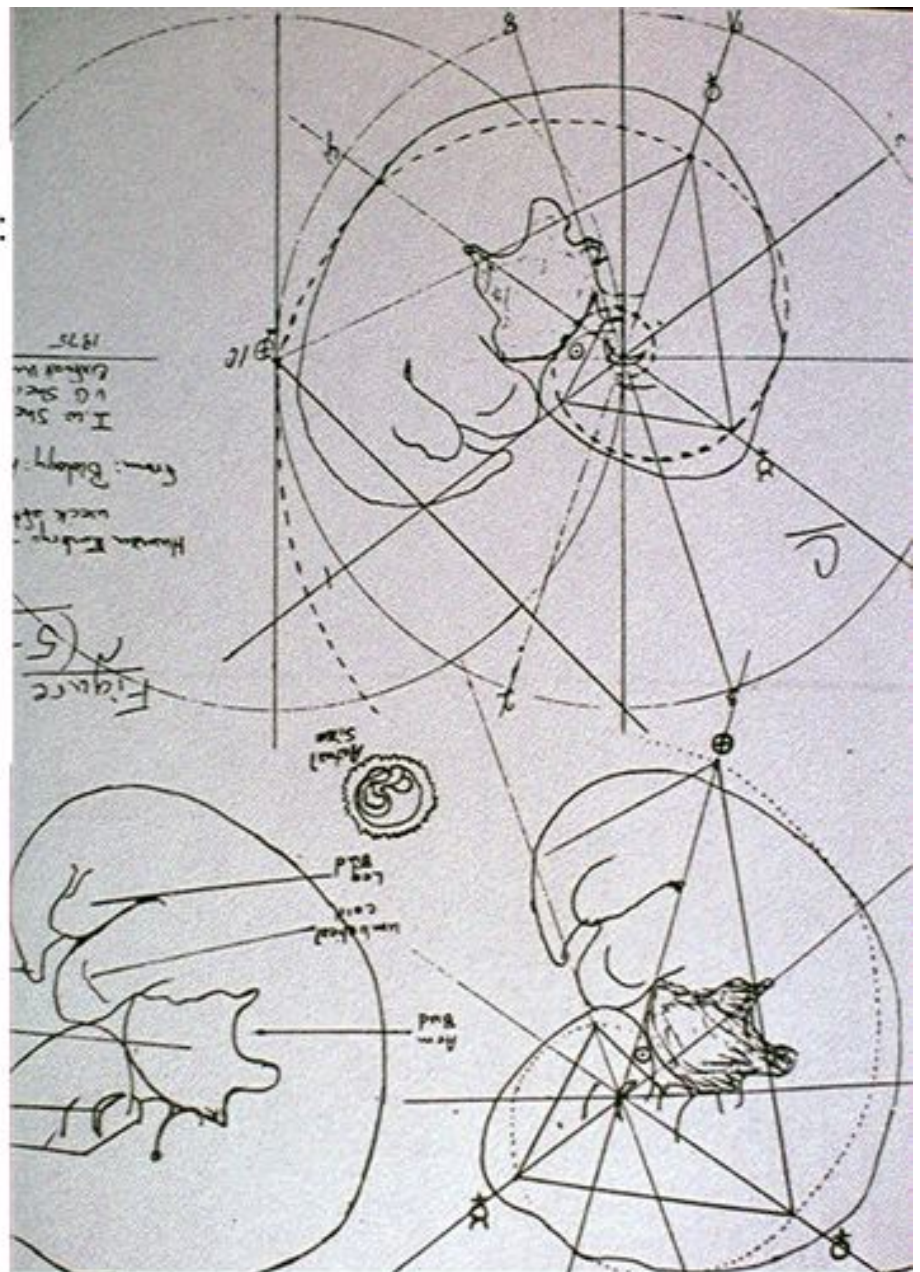
Forgetting none. “ End quotes from - Guy Bennett

## Fetal Development and the Golden Spiral: Growth Path-

by creating  
Non-Destructive  
Wave Compression  
(FOCUS)

BECOMES-  
PERCEPTION.

*Next section: Your soul is a tornado made by successful charge implosion. This is why the Druids used the center of an oak tree- to die. The Maori or the Cherokee -like their Annunaki ancestors- use a little hill fractal to the mountain behind it - a charge compressor- for death or birth. They would never approve of dying or birthing in a hospital full of soul dizzying electro-smog.*





## RECIPES FOR BIOLOGICAL IMMORTALITY.

- First of all, let us define: (from all best available data), where it is we need to go.

Answer: (in a phrase).. “Get yourself woven as a wave into the stars..” (all local waves are too short).

Immortality is mostly a way for people to talk about, how to get into a wave that is distributable - able to spread forever - and therefore sustainable. Your memory in your body is just a name for which patterns of charge get to keep going and not crash.

We have been childish in thinking only human bodies were inhabitable (able to keep awareness inside). The true science is that all forms that maintain FRACTAL COMPRESSIBILITY have the potential to be inhabited.

This is why babies (previous page picture) and galaxies (below) both have SPIRAL growth paths!



We explained how arranged charge waves into this pine cone or rose like ‘FRACTAL’ gets up to infinite numbers of charge waves all compressing or FUSING at one point. This process of getting waves of charge FUSED or IMPOLODED correctly - so that they can keep the donuts turning inside out - is called AWARENESS. It is the secret of LIFE and CONSCIOUSNESS! It is not that hard to understand. Use electricity and imagine one tornado inside another one - all with the same center. This is like the shadow of a sea shell.

When you take the action needed to place yourself in places where CHARGE compresses like this - it is much easier to get immortal. This is called going to SACRED SITES. But the real science of sacred sites is the science of designing CAPACITORS to hold charge. This is why it is so stupid when sacred sites like the Parthenon in Greece for example string up a bunch of metal wires to guide people around - because those wires BLEED AND KILL everything sacred about the place! It is just stupidity - not understanding what makes presence SACRED.

This is why for example most of the people historically proven to have lived for hundreds of years - always did it in caves and woods - and NEVER did it in a metal city building. Metal city buildings cost you your soul because they bleed your charge.

SO - here is our first requirement for immortality - LOCATE AND UNDERSTAND HOW TO GET AND REMAIN CHARGED!

It is helpful to understand just a little bit of the extra-terrestrial history of DNA and blood - in order to understand the background on immortality. (more at [goldenmean.info/enki](http://goldenmean.info/enki)). The gene- engineering family who started most of Earth's current humans - the Sumerian Annunaki - were mostly from Sirius - at that time. The 2 sons who made most of the trouble - were the product of a genetic problem. The 2 sons - Enlil/Enki = Yalweh/Adonia = Michael/Lucifer became the East of Eden, War in Heaven problem that today we call the Middle East war.

That problem was LOSS OF IMMORTALITY - requiring MACHINES to keep them immortal. This was the 'FALL' of blood radiance - called NEPHILIM in the bible (as we talked about). They lost natural biology formed BLISS and ECSTASY therefore the DNA in their blood stopped GLOWING with CHARGE.

For example - the 2 sons had the same Dad - (Antu - Biki) who was Sirian - called Dog/ Bird tribe. Antu is Sumerian, Biki is Aboriginal, Dog as in Dogon, Bird Tribe is Iroquois. (the IBI in IBI-ria & N-ibi-uru). Enki (Atun - Lucifer- RA - abRAham-Hermes-Thoth-Akhanaton-Tut-Ptah-PtaTaal) had a mother Aide (or ID) who was part Dragon. (The winged Draco type / Ciakar / Mothmen) she was probably from Rigel in Orion- blue blood. Enlil the other brother-in picture on left- (Amun, Yalweh, Michael, the encoder in Bible Code) had a mother Urash who was part Reptile.

The great Matriarch rulers of the Dragon line were called Assa. The Dragon (Draco) line itself was called URU. The movie Dune correctly locates the star Arrakeis (a Draco home planet) in Alpha Draconis. (Star mapped at Ankor Wat, & Chinas Sen Shi pyramids). The worm was Shai-ul-d - the UI in UI - URU.

Then the female leaders (mostly telepathic dominant 'Dragon queen' - origins of the MAG in MAG-dalen) of this line were called Assa-Uru. From this comes our words:

Din-assa-UR. Soaring.. (the Winged Draco's - think of Pterodactyl - Din-assa-ur). aSSa-Ur (soar) MEANS: to fly! Uru-Ssa - el-em = Jerusalem. And why is the AURA contained in aSaura-which means- to shine or have aura?? (implosion in the blood). AZURE-means blue-like blue azure sky.. etc.

Asuras - (Azores- Islands) in the Bible and in Bali meant Serpent or Dragon line. Later sauras or suras



*Left: Ibi-Uru (H'iburu /Hebrew)Blood Cross-This is Enlil..(Interventionist Anuhazi - later AshKhan-azi) - Right: Draco from Alpha Draconis - 'Dragon Queen' /ASSA-Uru (UruShalaim / Uru-an / Din-Ass-ur / Asuras) - MAG in Magalen is from Orion Culture*

came to mean SHINING ONES - charge radiant- versus Asuras or Asuras meant those who did not shine. This referred to the ability to spread a field effect of CHARGE from the blood - including the INDIGO - ultra-violet light - which comes from DNA when in BLISS, at meitosis (cell division) and so on. (The book SHINING ONES in UK, or the SHINING ONES in Lawrence Gardner's later books).

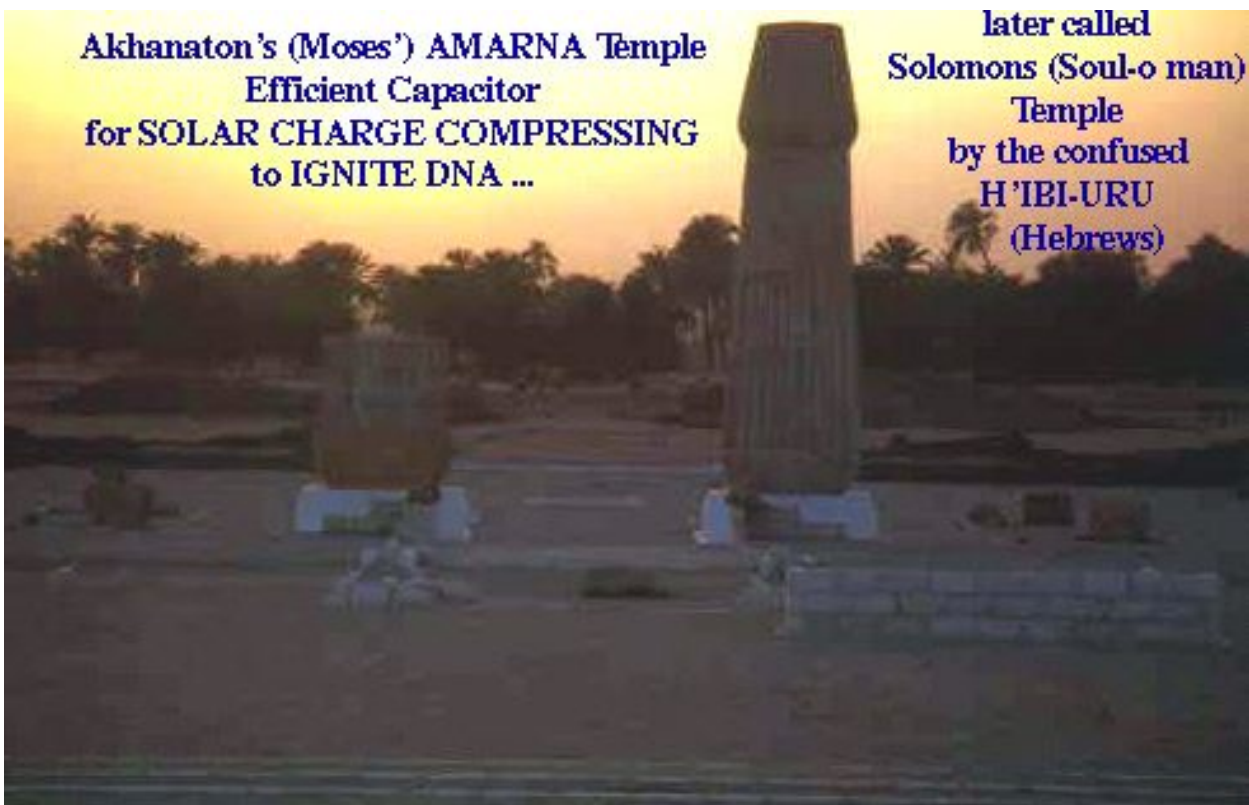
In the Bible - they are correct describing abRAham (RA- Enki) from UR (a blood line more than a city) and mating with Assa -of Ra.. Sarah.

For more on this colorful true story which is even more fun than Star Wars - best for you to go back to the book here - Return of Enki - at [goldenmean.info/enki](http://goldenmean.info/enki)



The point is that the family we call our ancestors in the Bible (which is mostly a bad translation of Sumerian- see Sitchen's and Lawrence Gardner's books) were a blood line cross with a **SERIOUS** gene problem. (Nephilim) These ones had lost the skill to sustain soul and gravity making in DNA. They forgot the science - of being **IMMORTAL!** ( new article on this in Earth's present drama: [goldenmean.info/invasion](http://goldenmean.info/invasion) ) **This is the issue this book is here to address.**

Their **GARDEN OF EDEN** - was a way to use capacitors on a grid layout (in a pattern arrangement) to prevent aging. The build of charge compressing into proper **FRACTAL- 'IMPLOSION'** was the proper support for **LIFE FORCE** electrically. The temple of Solomon (Soul-o-man - really Akhanaton's **AMARNA**) was a mechanical way of nesting or embedding those who lost ensouling **PASSION** - into **PLANET AND STAR ALIGNMENTS** using charge. Solomon's Temple was a **SUN** temple made by arranging rocks which were good capacitors into a **FRACTAL**. By lining up with the **SUN**- the charge was compressed needed to ignite DNA in blood. This was a correct skill to help get immortal.



Akhanaton's (Moses') **AMARNA** Temple  
Efficient Capacitor  
for **SOLAR CHARGE COMPRESSING**  
to **IGNITE DNA ...**

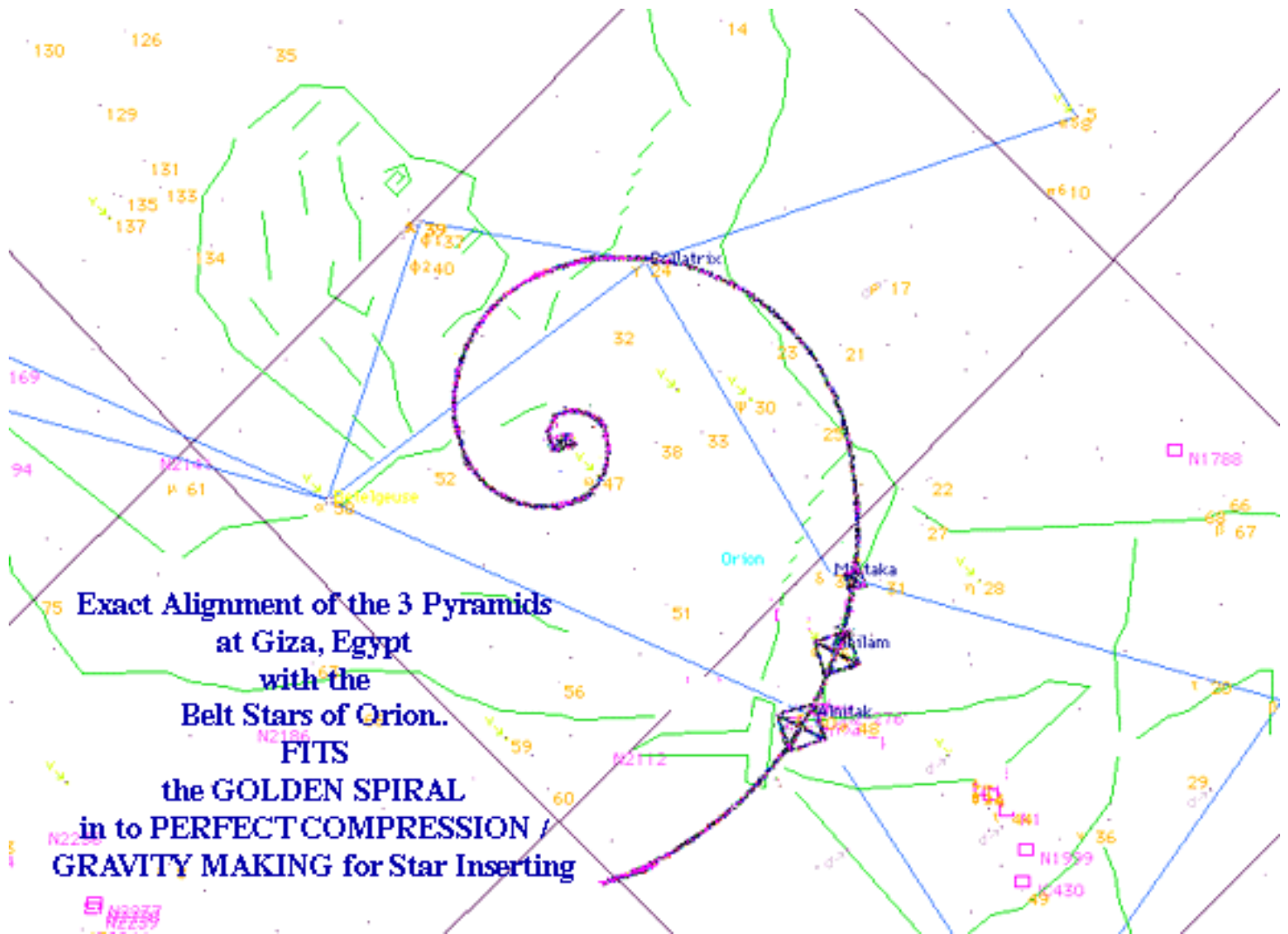
later called  
Solomons (Soul-o man)  
Temple  
by the confused  
**H'IBI-URU**  
(Hebrews)

Left: Example at **Matchu Pichu** - the spiral "G" rock capacitor at the temple center focused solar charge on Solstice - to ignite DNA for birth or death ritual (of the **Annunaki - Sun Gods**) - - see [goldenmean.info/peru](http://goldenmean.info/peru)



Herein lies a clue. Get yourself well embedded inside a charge wave, and this is a **LAUNCH PAD**. For example the **EL -ims-** port town in Pennsylvania operated magnetically. (see the dodecahedron craft shape in the movie **CONTACT**.)

**Gilgamesh** was angry that the **Annunaki** would not let him be immortal, so he wrote.. "turn left at **Orion**" and steer yourself into the stars.. that's how to get immortal! He demanded more access to the **Gold Powder** - holy communion- wrongly believing the **Draco** technology for agelessness could sustainably immortalize **ANYONE**.



The Annunaki star map on Giza ( [goldenmean.info/orion](http://goldenmean.info/orion)) was a charge compressing (‘recursive or self similar’ - & gravity making) PHI spiral pointing to Star embedding.

The ceiling at Dendara in Egypt was a shamans-tribal priest- map to steering by stars- during death or bliss.

“Jitterbug Perfume” from Tom Robbins - was a map to biological immortality. The water therapy, deep breathing and tantra-stillness sex.. plus the beet squeezins (compression) resulted in immortality. The heart muscle LOOKS like a beet - and when squeezed in the real compression of compassion - makes PERFUME.

Current science is wrong to say the sense of smell is particles (parts per billion) - our friend Dr Phil Callahan - clearly showed ‘olfaction’ (smell) is made up of INFRARED (light frequencies) in a “field” effect. This is why the room can fill with the smell of roses when a holy person enters. The DNA in blood can MAKE these frequencies. (PHI, PHIE, PHO, PHUM- — Fee - Fie -Foe Fum , you SMELL the blood of the ANgle-ish man). When the vampires in Ann Rice smell the blood - they are sharing a field that radiates among all DNA. These vampires cannot stand the presence of IMPLOSION - the FIRE in your heart - or the Sun. This is because lo grade DNA is toasted in the presence of IMPLOSION. Implosion is the tool for SORTING. Think of this later as we explain why BLISS prevents parasites - in you body and your aura.

The book “The Eight” was a chess board map to biological immortality.. The right gene-fires/ (passion) in extended family in the right symmetry chess board implode sustainably & immortalize. This is similar to getting the right extended family combination of bacteria in a cows stomach or a compost pile... A sustainable fire is the definition of the sacred as well as the immortal.



The how to die manual for the Cathars (Voynich), was a star map. Like the Tibetan Book of the Dead it maps the road turns for bardo (death vision) navigating. This is like the KLUVER map to what you will see when you die in order to steer. (Pics in this book P79.) [goldenmean.info/eternal](http://goldenmean.info/eternal)

Religion was a name for turning yourself into star waves for the mindless. Often the religious choose blind obedience which ultimately disempowers- instead of action based on understanding of pure principles - which takes the fire inside and makes you what you used to call GOD.

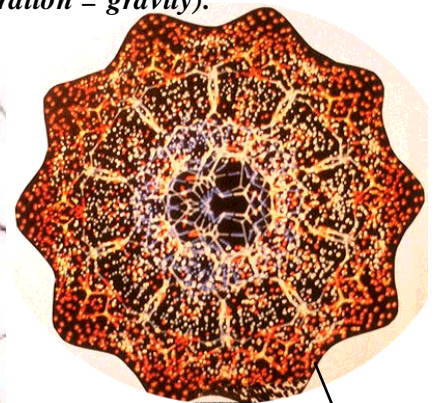
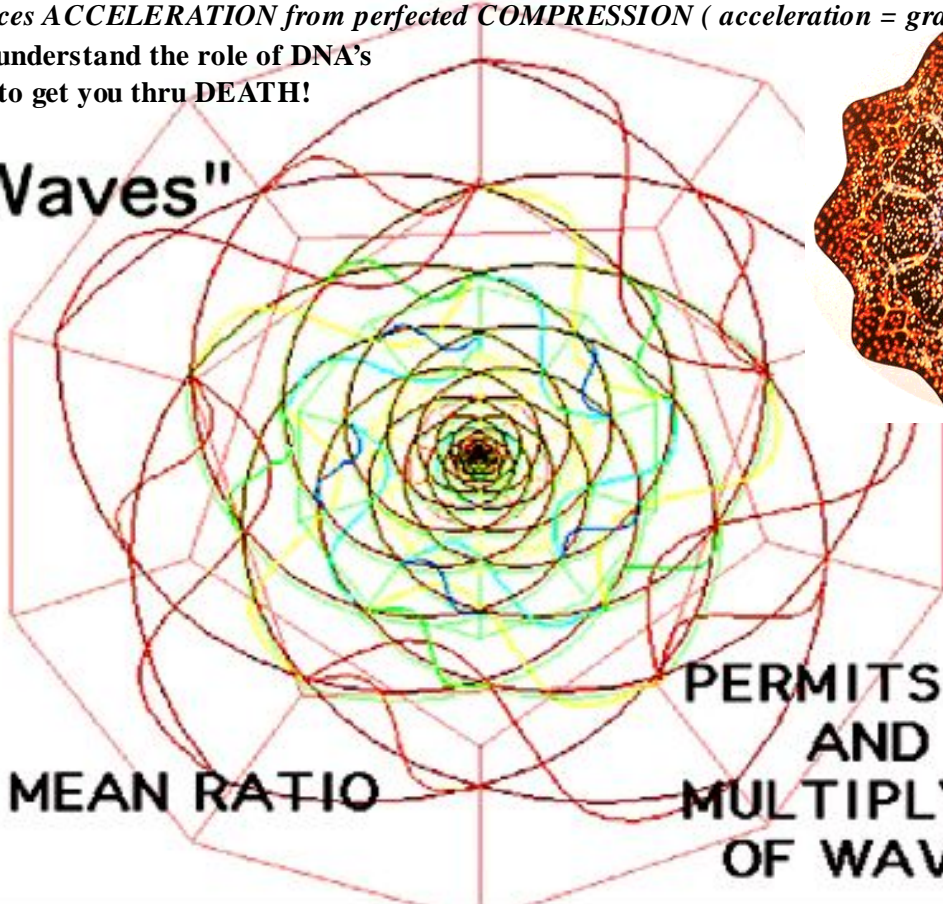
Now somewhere in all this Yalweh/Enlil meets X files drama between the Gold Eating and the getting yourself INTO the star map stuff, lies a PRINCIPLE TO BIOLOGICAL IMMORTALITY.  
- Let us line up our clues:

1. Gold Powder presents a pent (5 & PHI based) implosive atomic symmetry to blood solubility. At [goldenmean.info/gold](http://goldenmean.info/gold) see also for the valence picture map: [goldenmean.info/critmass/critmass.html](http://goldenmean.info/critmass/critmass.html). Ormes Golde Powder CAN exist in the totally "self contained" mono-atomic state precisely because THE NUCLEAR FIELD BECOMES IN-PHI-KNITLY DISTRIBUTABLE.. Makes a killer nozzle for DNA squirt guns. ref [goldenmean.info/water/nozzle.html](http://goldenmean.info/water/nozzle.html)
2. All the effective star maps were PHI / Golden Mean based PENT that is idealized into recursion/ embedding symmetry. (many examples at [goldenmean.info/eclipse](http://goldenmean.info/eclipse) )
3. The key portion of the INTENT field which made true ALCHEMY work to MAKE GOLD, was a PHI HARMONIC SERIES AROUND THE EKG.
4. Your DNA rings up alive, with PHI harmonics in your EKG ( [goldenmean.info/heartlink](http://goldenmean.info/heartlink) as the ultimate lie detector ), whenever your focus settles on something shareable (distributable). You become "hot blooded" when you have passion. The same tantric (sustained) DNA excitation was the verified trigger to time travel at Montauk and Incunabula. What is the connection between the word EROTIC versus the word ELECTRICALLY DISTRIBUTABLE?

*Recursive adding and multiplying ('heterodyning') of both wave lengths AND velocities creates a cohere-ing of wave front SPEEDS thru the speed of light. This opens the 'drain-hole' for charge to move out - PRODUCING the Phenomenon called GRAVITY. Thus capacitance (charge) in the symmetry of self-similarity or fractality is how gravity is CREATED because this successful 'heterodyning' of waves Produces ACCELERATION from perfected COMPRESSION ( acceleration = gravity).*

Now - use this to understand the role of DNA's great SQUEEZE to get you thru DEATH!

"Sine Waves"



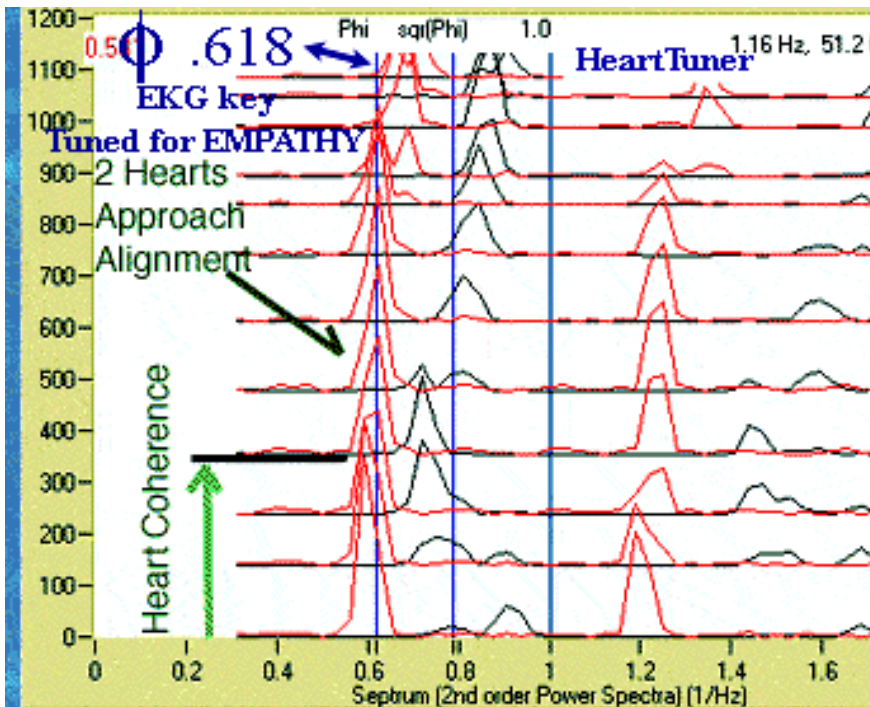
Compare with 5/10 Pent/ Deca Top Down View of DNA

GOLDEN MEAN RATIO PERMITS ADDING AND MULTIPLYING OF WAVES

The glue to hold the travel worms together superluminally (see the Dodecahedron in “Contact”).. enables coherent wave fronts to return from the superluminal, UNscrambled. (MEMORY../information.. see INCUNABULA time travel..) [Incunabula, Tantric wormholes and the bardo bridge, the antenna cocoon for human eros to produce shamanic time tunnels.](#) (See Gilgamesh and Incunabula)

Clearly, at the core of DNA seen vertically down the tube, we do see the same PENT symmetry as all the star maps, and in the outer valence of GOLD. (animations at [goldenmean.info/superDNA](#) ) Somehow the ability of wave fronts to add recursively their velocity thru light speed, creates a worm which ‘hauls ass’. We get erotically excited when the DNA legitimately senses a prospect for sustaining itself. This is exquisitely appropriate survival “instinct” (more REAL knowing) for DNA. (which REALLY KNOWS!)

There is a relationship between SEXUAL excitation and PHI harmonics in the EKG (learning to implode/



braid DNA by phonon pony tail field entrainment). We measured this recently very successfully in LA with a male executive stuck in your head type repeatedly unable to get any interval between EKG harmonics other than 1.0 hz (Emotional Index on the Heart Monitor). Stuck there (in his head/membrane making but no membrane bridging emotions), he begged his lady friend who then passionately KISSED him. Whereupon his EKG interharmonic interval (E.I. Emotional Index on the HeartLink ) moved (left) DRAMATICALLY toward the more sustainable .62 (Golden Ratio Embedable). This was by no means an isolated occurrence. We also see this in tantric couples.

Essentially during the REAL

FEELING OF REACHING OUT TO TOUCH (as opposed to holding in to CONTAIN), the fields around the heart re-create donuts that can implode/embed by PHI instead of OCTAVE or cubic ratios in their toroid voltage diameters. This creates a situation where more (charge) wave fronts can share pressures in PHASE to ONE crest, non-destructively OR as we say a distributable or SHAREABLE emotion.

So the same impulse toward a distributable EKG charge field which occurs in a little boy DREAMING OF GETTING A PUPPY, happens during EFFECTIVE KISSING. This IS NOT A BIOLOGICAL ACCIDENT.

Somehow “ASSUMING THE POSITION... OF A WAVE THAT IS SHAREABLE/DISTRIBUTABLE” is associated with the psyche of both WONDER and COMPASSION and EROS!

This is also proven in the SHAPE of the squeeze or hug or touch which MUSICALLY IDENTIFIES LOVE. See the SENTIC wave shape of the TOUCH OF LOVE - picture next page. By averaging the change in pressure over time - while MANY people expressed LOVE in a TOUCH- we see the GOLDEN MEAN RATIO. The LOVE HUG is unique because the time or point of maximum PRESSURE or squeezing by being tantrically delayed until .618 Golden Ratio into duration, creates a cascade which sends the energy of your love hug - right spinning down into tingling the DNA of your LOVER! (see pic)

This principle we need to understand, since presumeably it is literally at the “Heart” of the mechanism to biological immortality. In as sense, the psychological language for this road map to the stars, would be HOW TO ACCESS THE PASSION IN YOUR OWN GENES.



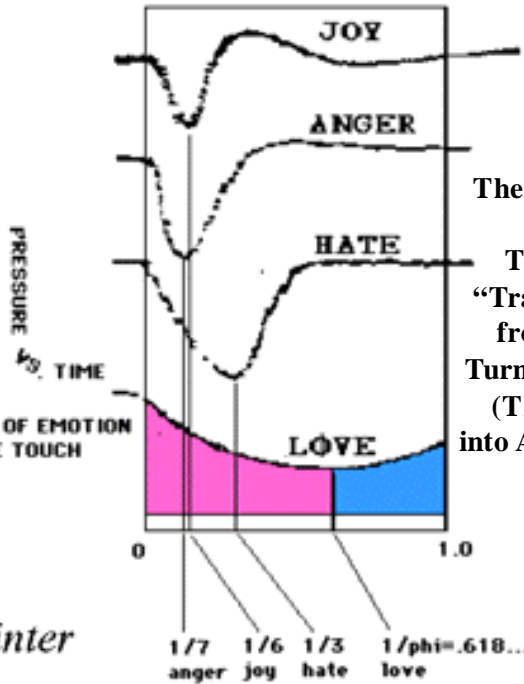


Plate 1. Recording dynamic forms of emotional expression with the artist model of the sentograph.

Sentics: Emotions Wave Shapes  
 First Identified Musically by Manfred Clynes..  
**microsoundmusic.com**

**LOVE**  
*has a WAVE SHAPE*  
*based on Golden Mean*

*Simple Pure "Sacred"*  
*Ratios.. Analysis by Dan Winter*



The Greek Letter PHI,  
 Golden Mean  
 The Perfect Ratio  
 "Translates" Vorticity  
 from circle to line..  
 Turns COMPRESSION  
 (THE LOVE HUG)  
 into ACCELERATION..  
 The BLISS.

Above- the musician Manfred Clynes discovered that the SHAPE of the way you touch (in music OR in love-making) determines what EMOTION you send! Making a graph of the change in pressure (touch) over time - we see that the TOUCH which says LOVE reaches it's point of MAXIMUM PRESSURE - later - about .618 GOLDEN MEAN into the event time. In other words you start a wave cascading down the caduceus of frequencies - efficiently by GOLDEN RATIO. Then your lover feels the tingle and rush - because the inertia has changed SCALE without changing ratio. This is why you feel a tingle in your DNA when you receive an academically correct LOVE HUG!!

more-next page & at:  
[goldenmean.info/touch](http://goldenmean.info/touch)

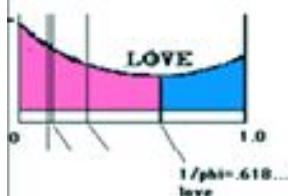
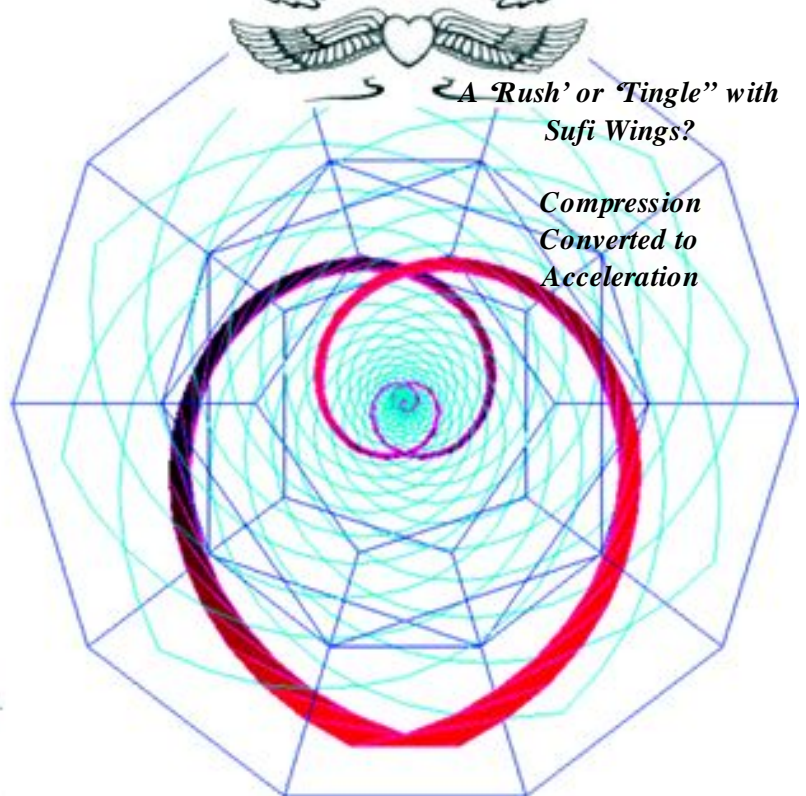
*Here is the 10 Golden Spiral - Top Down View of Your Own DNA -  
 Seeing the Arrival of the Charge Compression Wave  
 delivered by a LOVE HUG of the CORRECT GEOMETRY!*

Non  
 destructive  
 unfolding of  
 EKG  
 Magnetics -  
 Giving the  
 Heart  
 Wings..



*A 'Rush' or 'Tingle' with  
 Sufi Wings?*

*Compression  
 Converted to  
 Acceleration*



## 120 Can Science Cross Energy Lines With Dowzers - and Touch on LOVE???

excerpt from: [goldenmean.info/dowsing](http://goldenmean.info/dowsing) with thanks to Roger and FengShui Seminars.

If you were a skilled dowser or 'ley line healer' you might be quite wise to say "Why should I need a scientist to tell me what I feel in my BONES?!"

And up until recently, there could have been little understanding for a world of science in which there was NOT A CLUE to WHY — FEELING existed in bones.

The title to a new series of seminars we are doing with the help of Roger Green is "**Magnetism: The Wind on Which Love Travels**". Describing LOVE as magnetic wind going in to center - may be a romantic and still scientific notion. We must have a hint to what a scientific description of LOVE might be. Love appears to happen in the heart because of 'embedding' or 'nesting operations' (remember our Russian dolls that fit one inside each other repeatedly). These happen around the skillful heart's electro magnetics when you choose the turning inside out (compression symmetries) we call compassion. Perfect COMPRESSION and perfect COMPASSION are the same science. Make room for you inside of me - this is good squeezing - this is compassion - and this IS fractality.

This appears to show up in the HeartTuner ( [www.heartcoherence.com](http://www.heartcoherence.com) ) as the Heart (EKG) chooses musical key signatures based on Golden Mean (PHYlotaxis). It also shows up in the original Sentic wave map for the LOVE emotion as a shape of how to touch or squeeze. I did this unique geometric analysis of the international tested wave shape of LOVE, now reprinted at [goldenmean.info/touch](http://goldenmean.info/touch).

### HOW TO TOUCH..

How the Geometry of Pressure in Your TOUCH - Predicts the Harmonics of EMOTION IN MUSIC- & LOVE?

*Picture on the previous page - adapted from Sentic Wave Forms from Manfred Clynes [MANFRED CLYNES Web Site, http://www.manfredclynes.com/](http://www.manfredclynes.com)*

Supposing someone you really LIKE hugging said to you: **you ought to learn how to "touch"**. The scientist who originally studied geometrically how to properly touch, is named "Manfred Clynes". His first book on the subject is called "Sentic", another is called "Music, Mind and Brain". His work on the known wave forms to express emotion, as a concert violinist, was also featured on the Nova series, "What is Music". See his web site, for music to make just emotions you design - by wave shape.

It is kool to realize he decided to study the musical SHAPE of the wave for LOVE - because he found out that the SHAPE of the way he TOUCHED his violin string while playing was what CAUSED PEOPLE TO CRY!!

Let us actually apply this information to learn how to touch better. Manfred developed a set of Sentic Cycles, in which people were given sequences of touch and visualization exercises to express emotion.

By way of intro, in Sentic, Manfred simply has you change the pressure in the way you touch over time, and thereby express FEELING. So in the chart above, the way you would change your touching pressure as you touched a spring, was mapped. (Visualize the "sentometer" as a simple button on a spring; put a pen on the button and run a chart recorder behind it, and you get a map of the change in pressure over time on the button.)

We need to understand this simply, in a way that permits us to use this information to be better touchers.

Imagine that you were walking up to someone very important to you. And you were about to give them a big squeeze hug. And it was very important for you to know that your squeeze definitely conveyed the emotion you intended. This is where this chart comes in handy.

In order to understand how to squeeze better, it is helpful to begin to think of your squeezing skills, as a "GEOMETRY OF PRESSURE". At first this seems painfully analytical. But consider it this way.

A squeeze, ( or hug, or touch)... consists of basically THREE events which we may chart, as above.

The FIRST event is:



Event ONE: The **BEGINNING of the SQUEEZE**

The LAST event is:

Event THREE: The **END of the SQUEEZE**.

Now, somewhere in the middle area above there occurs the MIDDLE OR SECOND EVENT:

The **POINT OF MAXIMUM SQUEEZE**.

—

Now this may all seem a bit strange, to **begin to think of your squeezing time, during hugging** as:

**begin event..**

**peak event..**

**end event..**

but actually this IS going to **help you be a better hugger, + better at love!!** so bare with me.

If you begin to notice how soon the max pressure occurs in your hugs, you can begin to conceive of a RATIO. Was the max pressure in my hug  $1/7$ ,  $1/6$ ,  $1/3$ , or  $1/\text{PHI GOLDEN MEAN}$  into the duration of my hugging. This may at first seem to collapse the intentional rich spontaneity of hugging, but I suggest to you that the skill to hug properly, while instinctual (as Sentic proved), may also be optimized and learned, and then become instinctual at a higher level.

—

You see in the chart above, I have added to the waveforms something not in Manfred Clynes Sentic. I have made note where the point of MAXIMUM occurs in each squeeze play. AND IT IS FROM THESE ORIGINAL ADDITIONS I HAVE MADE, that I HAVE SUGGESTED THE RATIOS IMPLIED BY THESE EMOTIONS ON THE BOTTOM AXIS.

Simply put, if you want to send joy, then the point of maximum pressure in your squeeze (hug), should be about  $1/6$  into the duration of the hug or squeeze. One sixth makes a wave hex whose edge length equals its radius, planer and space filling, but not inherently lifting off the plane it finds itself in. Good for fixing an emotion, not good for sending. The witches hex fixes.

Now, on the other hand if you want to send anger, your point of maximum pressure will be sooner during your squeezing practice: about  $1/7$  into the duration of the hug or squeeze. The seventh creates destructive harmonic interference among waves, which may be useful if you are chasing money changers out of a temple.

Now, here comes the fun part of learning to hug better. If you want your hug or squeeze to explicitly indicate LOVE, then the Sentic wave forms for emotion, tested to be a universal language for cultures the world over, have some specific instruction for you.

The HUG THAT SAYS LOVE, is one where the point of maximum pressure is approximately  $.618$  or GOLDEN MEAN, into the duration of the hug or squeeze. ... What this says is that the love hug is explicitly more restrained initially, it is almost tantric. Specifically, you don't go for the rush right away, you let it build awhile.

And you can test to see if your love hug, according to academic standards, did in fact succeed. You wait for a little while, afterward, in gentle but specific stillness, for the love hug you just gave to settle in. (Mother said: "He's not talking while the flavor lasts".)

Then you simply ask your experimental huggee:

"Did you feel a tingle in your DNA?"

Let me explain why this is the correct Electric Kool Aid Acid Test, for proper academic rating of love hugs.

You see, by creating a squeeze geometry of pressure, at the ratio of close to the Golden Mean, you have solved the “bifurcation puzzle” (problem of separateness for waves), and you have sent a wave cascading down the kite string, or cracked whip, from long to short. (Pic.p.81) You divide a wave in this way. (The PHI-lo tactic perfect branching all-go-rhythm.. Scion... John=branch of fractal tree). The big part to the little part as ratio, equals the big part to the whole. This starts a wave INTERFERING WITH ITSELF NON-DESTRUCTIVELY.

And what happens when your hug wave does this? Your hug pressures add and multiply all the way down the PHI wave (Jacob’s best) ladder. And the spin of pressures cascade RIGHT IN THE HUGGEE’S DNA. So you need to know if they felt the TINGLE!!! This tells you if their DNA implode braided just a little more toward perfect embedding, in response to the perfect embedding of the (piezoelectric muscular) geometry of your hug. If so, then the spin density of the wave in their DNA became a bit more sustainable (recursive). AND THAT THEN MOVED YOUR HUGGEE APPROPRIATELY JUST A BIT MORE TOWARD IMMORTALITY. (& see grail animation of braid perfecting in DNA entrained by EKG of LOVE)

**If this moves you to practice... ( more time for hugging...?)**

What all this means, is that there is a clear connection between a change in pressure over time ( pressure or tension was Tesla’s name for volts), and the EMOTION of love. Simply put, indeed if you do get magnetic - electric lines into the right GEOMETRY you do appear to get a self-organizing CENTRIPEDAL inward rushing CENTERING FORCE. (As we have described IMPLOSION).

**Implosion is a HARVEST OF MEMORY (the attraction of CHARGE- the ultimate form of biological information/ memory).**

--

**“Have you harvested any genetic memories for the galactic core today?” You can tell if you felt your blood rush: the tingle in your DNA. That genetic wisdom IS NO LONGER A COLLECTIVE UNCONSCIOUS.. it NOW HAS A VOICE.. (I am feeling right now as I write THIS sentence, such a tremendous tingling all over my body, that I must ask you if you are in here with me RINGING? ) It has become self-aware, and is thus (correction to Jung here) now a COLLECTIVE CONSCIOUS.**

**It could SELF-STEER. That SURVIVAL is, like our republic, if we take self-responsibility FOR and.. INHABIT/EMBED AND FEEL FOR... THE WHOLE. This is not the same as: ‘how comfortable it is to let ‘God’ (the borg) (something OUTSIDE me) do all the steering!**

**The use of the term GOD here is tricky, because on the one hand it’s current usage AS A WAY TO MAKE PEOPLE GIVE UP DISCOVERING WHAT STEERS US INTO STARS FOR OURSELVES, is clearly a travesty of enslavement used by the Reptilian priest/kings heritage to CONTROL. (Don’t FIGURE OUT FOR YOURSELF THE PURPOSE OF YOUR EXISTENCE, your GOD/master/enslaver will do that for you). This is very much confused BY THE PRIESTS WITH ALCOHOL ON THEIR BREATH, with making GodLessness the same as having no respect for the Collective Intuitive Awareness (the REAL CIA). Respect for (becoming embedded in) the wave of ecstatic electricity growing inside our VERY SHARED DNA WAVE, IS INDEED THE MOST HIGH POSSIBLE SPIRITUAL EXPERIENCE. The shameful pathetic agony of eating a little host (communion), meant originally to be white gold powder cake, absolutely PALES IN COMPARISON TO A MOMENT OF TRUE ECSTATIC COMMUNION and sustainable kundalini/tantra. (ref: [goldenmean.info/kundalini](http://goldenmean.info/kundalini) for psychophysiology of environmental effects.) Yet you may not often find a priest teaching true ecstatic movement BECAUSE THAT MIGHT END THE NEED FOR PRIESTS.**

**Clearly:**

**1. The experience of PASSION is related to getting into the geometry of embedding . Sex is better in a pent circle of old druid Oak trees for a REASON. Tantra is more effective when located ‘embedably’ in**



time & space (both need to be fractal). Stars mapped on Earth archeology (like ORION at Giza) were examples. REAL Astrology is actually measureable as capacitors change charge levels effected only by major star alignments. Ref: the Greg Hodowanec work. Gravity is a name for capacitance gone fractally implosive as a charge wave. Ref: [goldenmean.info/predictions](http://goldenmean.info/predictions)

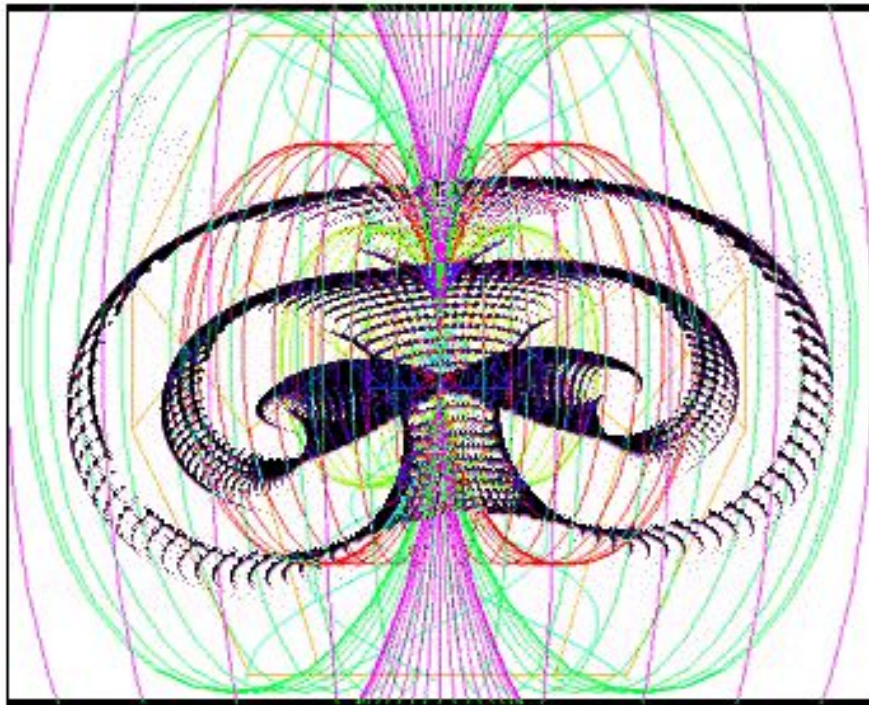
2. Getting DNA braided into sustainable implosion - WHICH IS BIOLOGIC IMMORTALITY- is exactly the same as getting it's wave structure into PHI harmonics. ( [goldenmean.info/superDNA](http://goldenmean.info/superDNA) ) DNA comes from our parents with whole lots of PHI ratios in its natural MICRO structure. HOWEVER, increasingly braiding the LONGER WAVE (EKG PHONON & LONG WAVE piezoelectric "singing") MACRO STRUCTURE into genes, requires the investment of coherent emotion along with the disciplines of principled hygiene. If you eat fractionated(too chopped up) or angry DNA and sleep in a metal magnetic jungle city, then your heart's fire & your bliss dies.

**FOLLOW YOUR BLISS:** There is no specifically esoteric secret about what will get your blood boiling. You already know. You have just been ignoring it. So here was a little pent/phi recursion symmetry physics to move you to decide to listen. Go where your DNA sings and you will inhabit stars. Choose convenient assimilation, and you will join your borg ancestors in the only hell there is: the destructive unembedable wave interference called "heat" where the uncompressible (waves/people/DNA) are sorted from the shareable.

--COMPASSION is the COMPRESSION that results - from your HEART learning to turn INSIDE OUT..

The RUSH of BLISS is the CHARGE this Attracts!

## How Does PHI/Golden Mean Based Recursion Create Dimpling



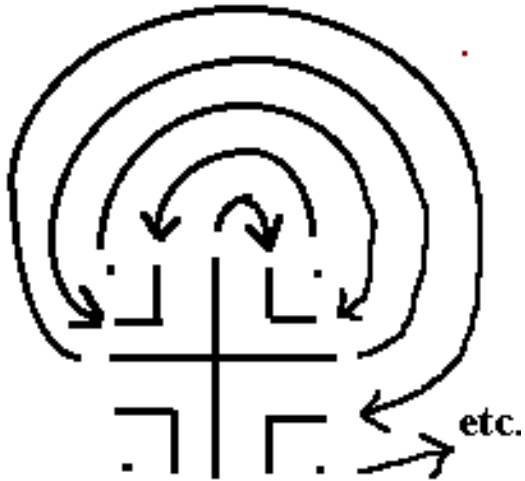
### Inside Out-Ness?

#### -Primer on TORNADO STEERING:

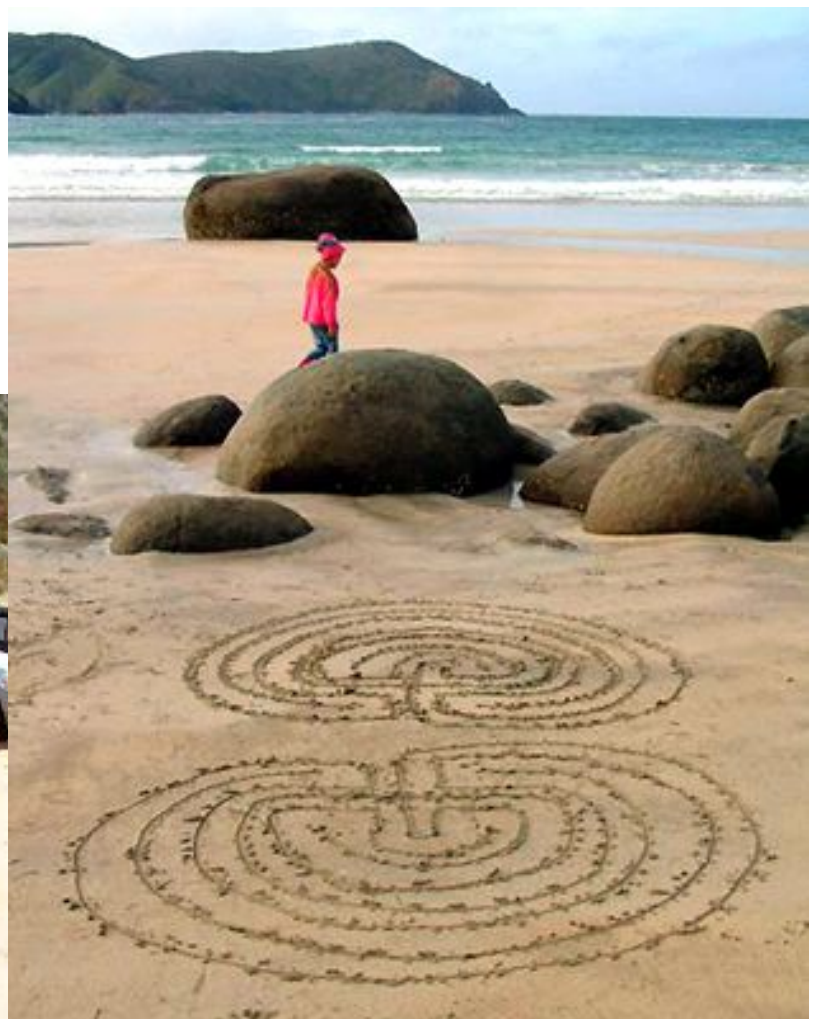
This learning to turn inside out again and again (recursively) starts a 'DIMPLING OPERATION' which gets so many tomadoes imploding into a common heart - that FUSION - perfect centering force results. The reason this skill to SELF-REFER or SELF-REENTER (self-reference is the best definition of self awareness available in the Vedas or in geometry class), becomes 'self-organizing' is because the wave recursive adding and multiplying compression - makes a continuous spin path thru the speed of light. This way out for inertia of the

padded cell, we call mass (tornadoes with enough inertia to be measured), is such a great relief for all the waves trapped here, that they are willing to get in line to talk to the only modem hooked up to the more information dense world past the speed of light. Our working definition of getting a soul, as a scientist, is the skill to implode your DNA braiding to get the tomado up the genetic zipper sustaining it's wormhole thru the speed of light.

**THE LABYRINTH:** teaches the ultimate map to successful turning inside out - ness. Visualize the **SURFACE TURNING** skill learned in your body from the labyrinth - into what you do **INSIDE** your heart when you **CHOOSE** to feel someone outside **AS IF** they were inside. This is the 'New Sacred Geometry of Compassion'.



How Does PHI/Golden Mean Based Recursion Create Dimpling - Inside Out-Ness?







Now imagine the Heart Learning the Teachable Skill we Have Called Compassion, like a child learns how to digest foods. It is as easy as choosing to turn yourself inside out-except right in your HEART!. Do this by creating this Electrical Ratio in the Heart Magnetic Harmonics.. directly .618 PHI from the above graphic, in the Heart!.. made visible with [HeartTuner biofeedback..](#)

When the heart's (EKG) musical key gets to Golden Mean ratio - we see people moving from head centered - to empathic - or open heart centered emotion.

This ability to MAKE a center of GRAVITY by creating magnetism in a shape which dimples, recurs, and implodes - in your HEART and in your DNA: - is the very essence of :

1. Implosion,
2. Artificial Intelligence, - the PATH out of CHAOS..
3. The connection between CHARGE and GRAVITY,
4. FUSION.

The PRINCIPLE is that PHI or Golden Ratio ( .618... ) is the SECRET to FRACTALS! (How to GET self-similar).

And ALL scientists know FRACTALS are the SECRET to COMPRESSION!

And NOW - YOU know that COMPRESSION which gets infinite BECAUSE OF GOLDEN RATIO - turns IN to ACCELERATION.

And ALL scientists know that ACCELERATION and GRAVITY are the SAME THING!

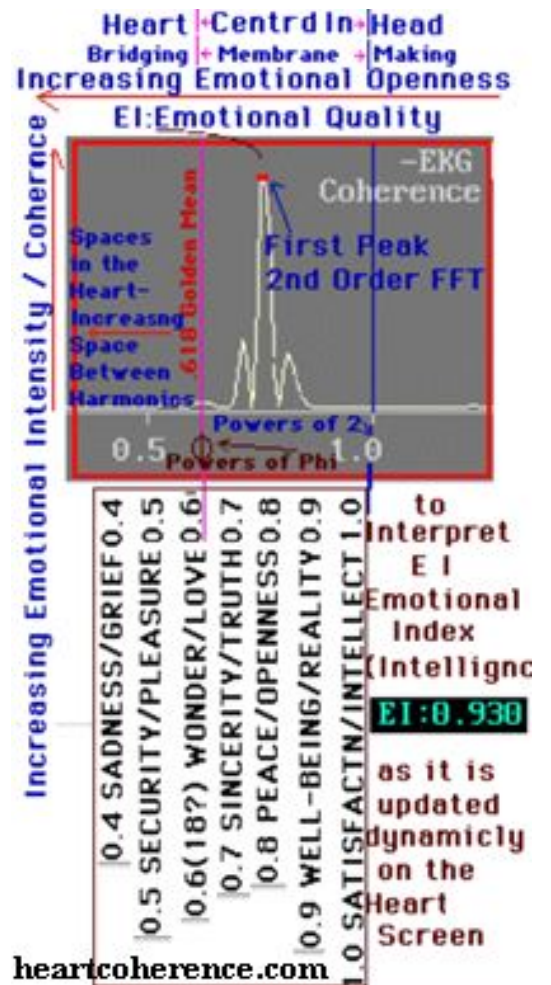
So GOLDEN RATIO is what helps waves turn COMPRESSION (squeezing) in to ACCELERATION -> GRAVITY!

So this is WHY Golden Ratio is the KEY to how your HEART and your DNA MAKE GRAVITY!!

The REASON why you need to know HOW to make GRAVITY in your blood with your genes (DNA) is that THIS IS THE ONLY WAY TO GROW UP AND BECOME A STAR!

The WAY - DNA in blood gets ignited (radiating UV - ultra violet or INDIGO) is BLISS and ECSTASY and this IS the key to getting waves sustainable.

Sustainable waves is scientific language which really mean- how to get IMMORTAL!!



## THE SECRET OF DOWSING ... AND SHAMANS WHO FEEL IT IN THEIR BONES:

**Let's** get back to our question about how you FEEL magnetism in the land - in order to better help steer it to turn inside out. In general this work is called DOWSING - and it is part of the skill to be a good GEOMANCER. Our job is to understand enough about the SCIENCE of how these things work - in order to use them in a self empowered way. If we understand the PRINCIPLES - we shall not be lost in the pudding when things get sticky. (We can figure out situations for ourself - and become SELF steering - like the tornados which NEED to steer themselves - in order to be self-aware. Tornados sometimes make choices.)

**Imagine the** role of calcium in your BONES storing LONG WAVE magnetism 'piezoelectrically'. (Piezo-electricity is just a name for how a well squeezed slinky or coil spring works. This is how sound or mechanical compression is connected to shorter voltage waves in slinky coils like DNA and Quartz.. You stretch your slinky - the sound wave is long - and the width or thickness of the slinky gets SLIGHTLY shorter - this is the voltage connected by leverage of helix from long to short wave ).

This piezoelectric nature of bone is how you store the shape of the shock wave of your step on the land, into your bone. It is like how the geometry of touch pressure is stored as armoring in muscle, except longer wave. When you take a step in 'rhythmic traverse' out of 'flatland' called 'dance pilgrimage' and the charge density called 'a moment of BLISS' walks permanently 'piezoelectrically' into your BONES. Do this often enough, and you get an immune system. Forget how - you get AIDS. (Someone should compare when BLISS DANCING went 'Out of Africa' versus when AIDS went in.) Suddenly we get a good glimpse why it was good physics for ancient tribes to grind and drink the bones of their ancestors in order to eat their memories.

Now did your local dowsing whiz NEED me to describe that, in order to dowse better? Well possibly not, but let's suppose the same dowser get's just a little closer to real shamanism, and bumps into a little "Sorcerer's Apprentice" problem. (reference: Walt Disney movie). The MAG(netic)ician suddenly STIRS up more spinning than he can steer. At that point, he might well appreciate a little more practical physics for plumbing these wormholes non-destructively. Let's investigate our troubled magician dowser's wormhole vortex steering dilemma with one of our favorite teaching stories-

'The local Mayan student shaman get's a test one day, when given the task to go out from the local village and save it from an approaching tomodo. He follows his shaman teacher's instructions carefully and images inside his heart a picture of the FEELINGS of the TORNADO being magnetically sucked into his belly. His teacher called this 'Eating the HOOCHA' (eating the ANGER - Sentic wave for anger =1/7 which is all unshareable or destructively interfering waves) of the Tornado.

.At some point by feeling magnetically for the feelings of the tornado better than it was able to feel for itself, the tornado 'falls in love' with the shaman - who succeeded in wave embedding himself into the **center of gravity** of the tornado. By making a little picture inside his heart, which is SELF SIMILAR (or FRACTAL) to the bigger picture of the SHAPE OF MAGNETISM (literally the FEELINGS) of the Tornado - the result was - the

OUTSIDE FELL IN.

(Mathematicians call this operation of perfect inrushing compression: perfect fractality - perfect inward self-similarity - like zooming infinitely into a fractal or fern tree inside fern tree.). If your were a plumber observing these wave vortex operations of the student shaman, at that point you would have observed the big twister begin to follow the young shaman around like a favorite little pet puppy dog.





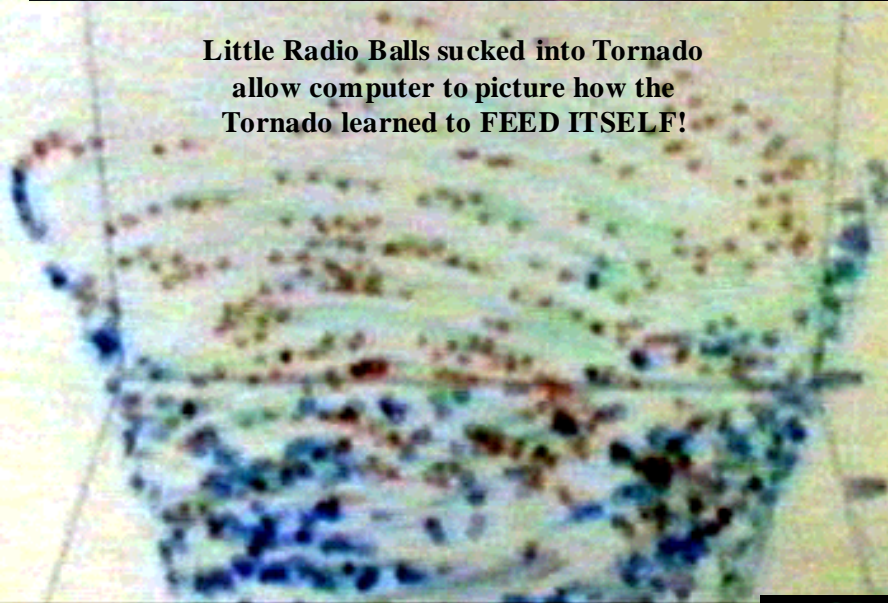
So this is our teaching story. It appears to have a 'happily ever after'. Except for one minor detail: is the village REALLY saved? Now Mr. Shaman in training sir, WHAT DO YOU DO with that big tornado which could cause an awful lot of trouble, which has now elected to follow you around. THIS is the "Sorcerer's Apprentice" problem so nicely scientifically prefigured in Disney's "Sorcerer's Apprentice" cartoon movie.

Step 1: Stalk the Tornado (Scenes from Twister)- previous page picture



Step 2. Trick the tomado to suck you into it's center. Here the tornado sucks up the digital tracking transmitters which allow the computer to plot the geometry of self re-entry spin path symmetry. This skill to learn the path necessary to feed itself is how the tomado became self organizing. (self re-entry = self-awareness?).

**Little Radio Balls sucked into Tornado allow computer to picture how the Tornado learned to FEED ITSELF!**

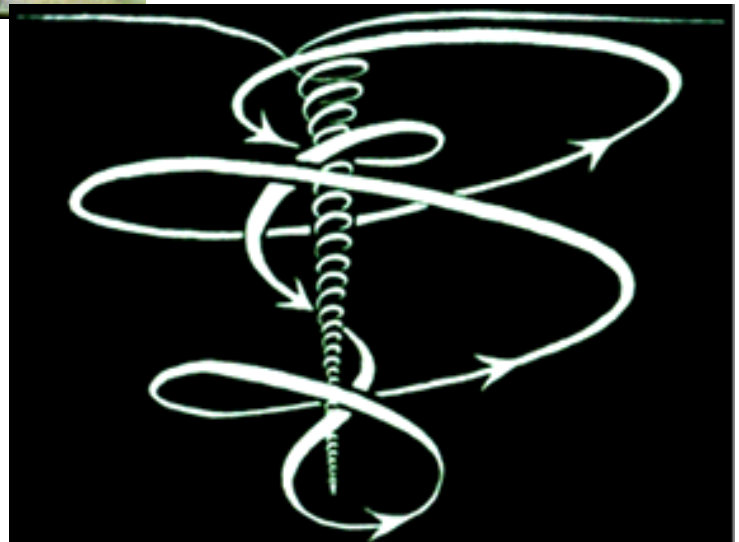


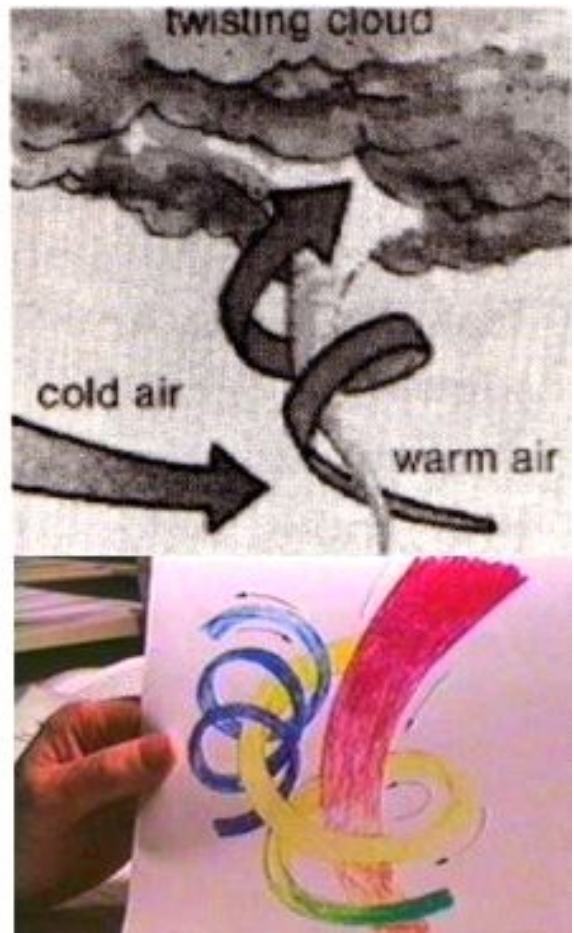
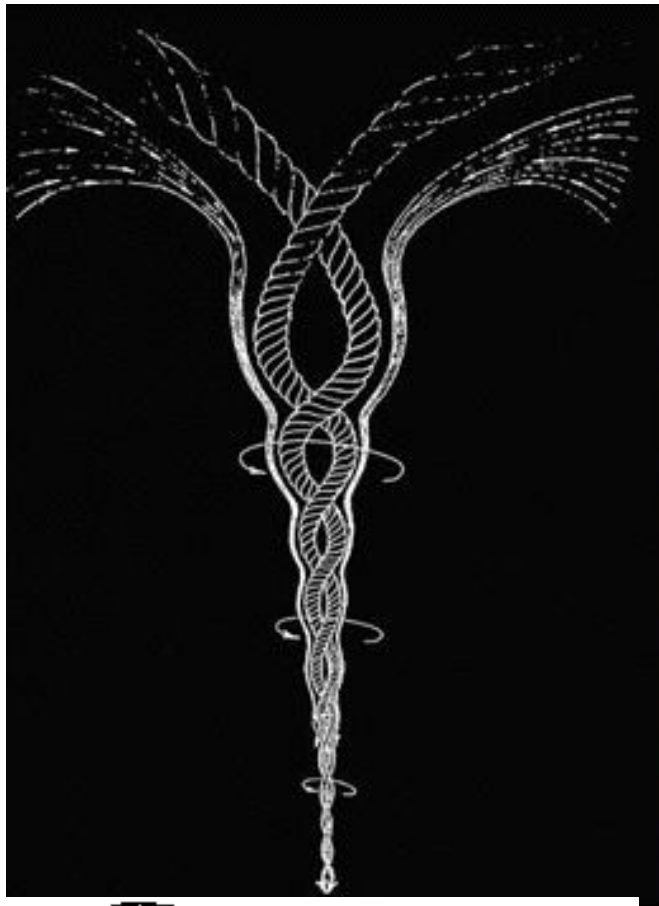
Step 3. Learn the Spin Path to Self Re-Enter. Here (by telemetric tracking of the 'suck' path of the magnetic node balls..) the computer in the movie begins to plot the secret of where the tornado learned to steer waves back into itself - becoming to some extent 'Self Aware'?

Step 4. Apply this knowledge to learning how to squirt your own magnetism (like a breath of cool air) into the center of the tomado. And thus become the center of the tornadoe's self-aware slip knot center of gravity

YOURSELF. (Bottom right - wave on a wave on a wave = embedding = prefect nesting = perfect braiding...)

Step 5. Plot this geometry of perfect self-re-enter as symmetry turns, so that the picture can be a trail to follow for your children to know how to enter tornadoes. (and stars?)

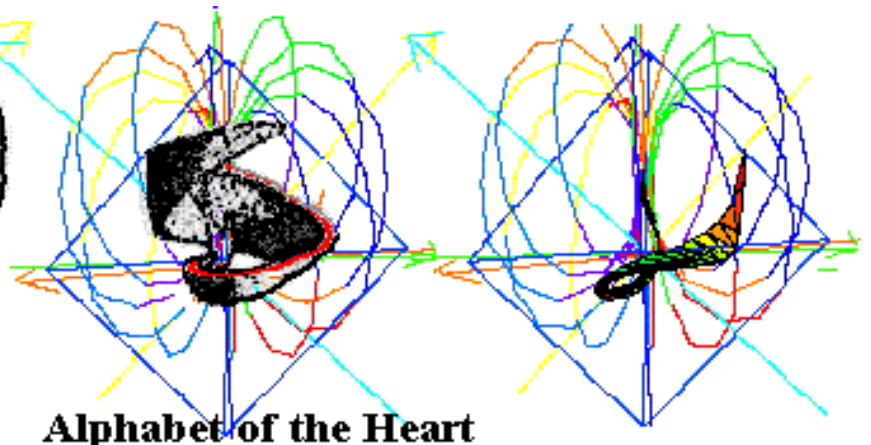
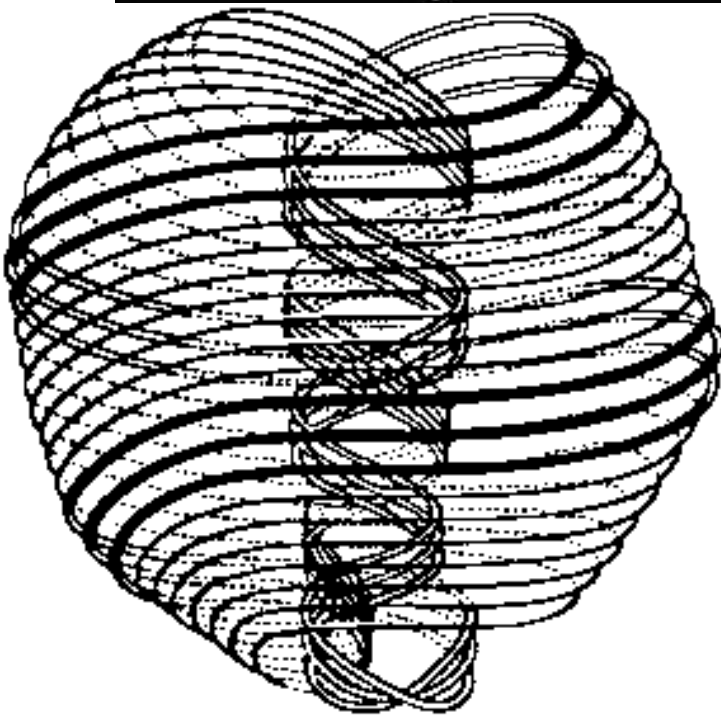




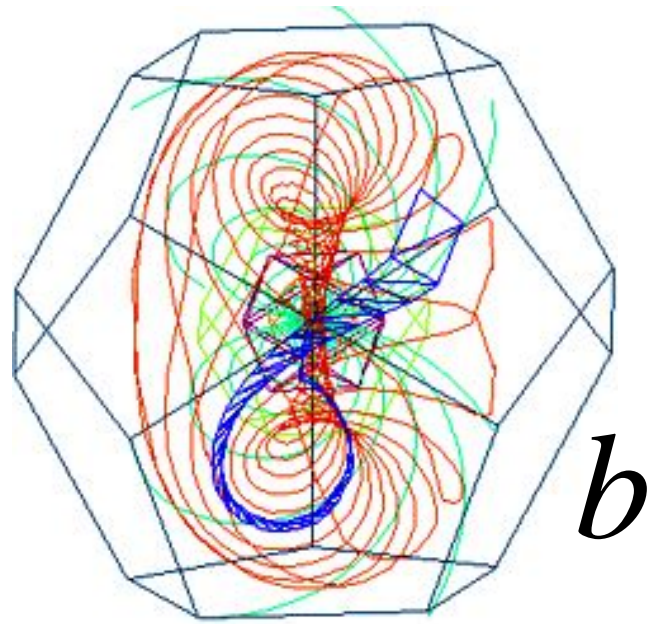
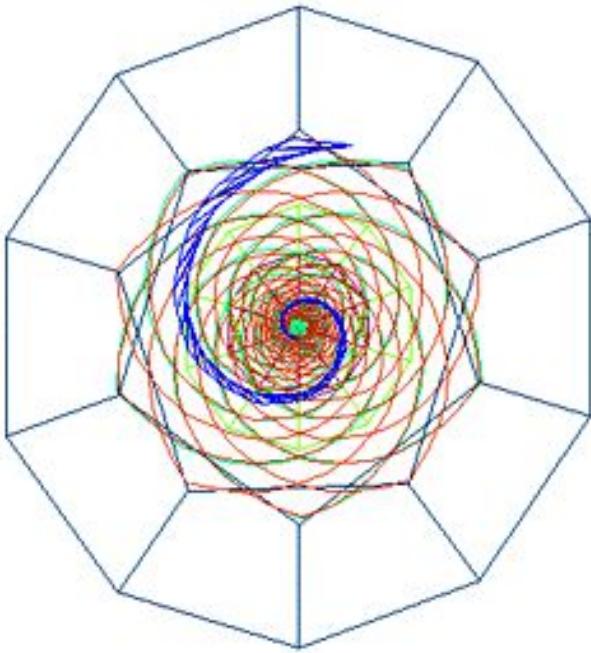
Step 6. Compare the geometry of the perfect Gordion “Slip Knot” turning inside out-ness.. to the known plots of the geometry of the Heart of the Sun (seen clairvoyantly - top left in the below image). ... to the Geometry of the Anu (Occult Chemistry map of hydrogen - see new physics: “Psi Perception of Quarks”, and the geometry of the HUMAN HEART where the knowledge to tie this slip knot appears to radiate.

See ANU slip knot compared to Heart P10.

Could this Self-Organizing Slip Knot Implosive Connector to the ‘ensouled?’ or ‘etheric?’ world of the faster than light, be the “Tourbillion” - “ScrollWork Made of Light” referred to by Mouni Sadhu in “The Tarot”.







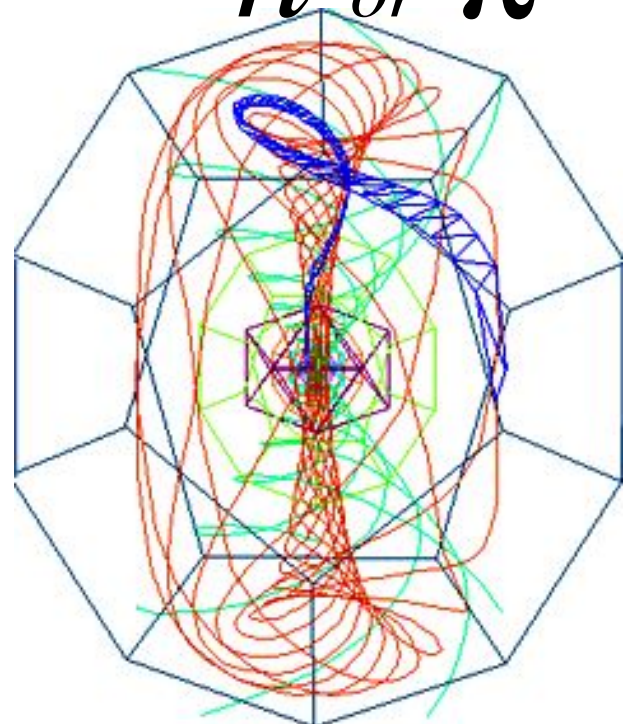
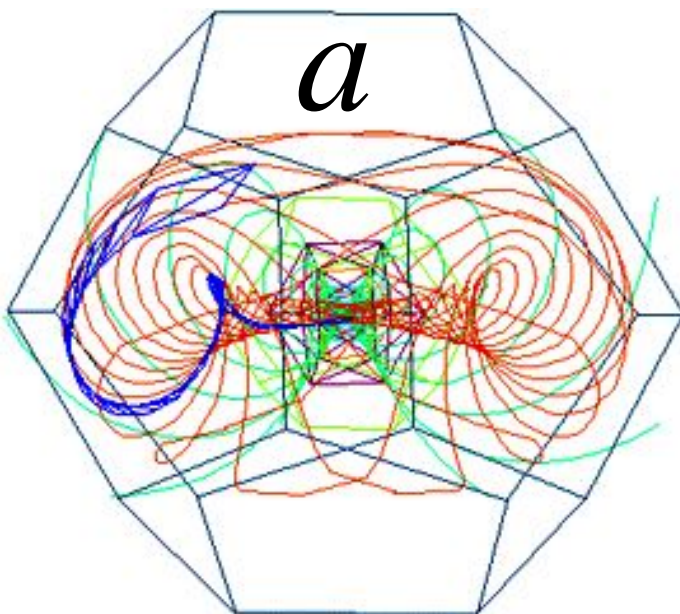
This “Alphabet of the Heart” is the nest of simple donut torus shaped field effects, whose symmetry permits pressures to share space.

In our Unified Field, the inertia of coherence which occurs when spin is stored in what we call ‘matter’. When the charge compression becomes recursive or self embedded and **FRACTALLY ATTRACTIVE** - as a wave form we call this **IMPLOSION** - and **LIFE FORCE** and even **MIND**.

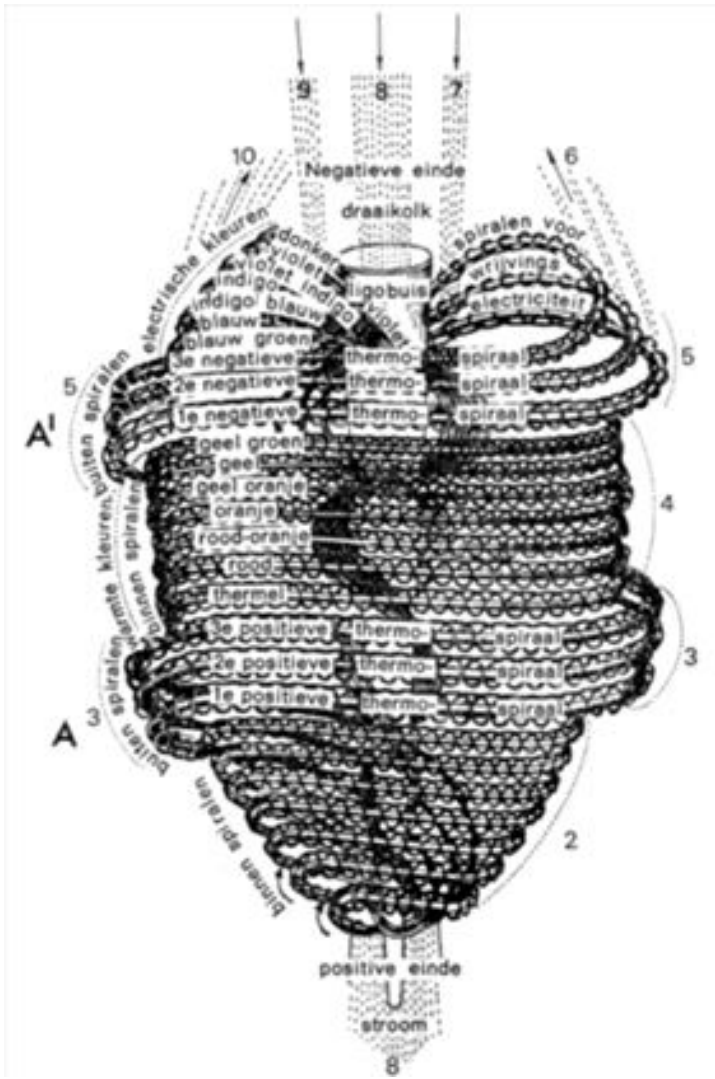
Because the 7 layers of heart muscle are exactly tilted in the 8 possible mirror spin axes of the tetra ( the basis of all symmetry), the heart can throw the blood in a series of vortices, in any angle in 3D to nest spin into all the phase angles or tilts of **CREATION!**.

These same traces of the “Flame Letter” self organizing spiral on the donut, created our **ALPHABETS**. They fold into our memory / membrane the foldedness of all creation. The electrical and sonic shadows of this alphabet of the only symmetry that ‘matters’ - the language of light - braids our immune system on the thymus gland - like a catchers mit around the heart’ - recording **SHADOWS ON THE WALL OF THE CAVE**. The only way into the next dimension (spin symmetry).

$h$  or  $\pi$







**The Flame Letter origin of alphabets are shadow views of the self-organizing spiral on the donut .**

These ARE ‘consumed perspective’ called ‘e pluribus unum’ - from MANY there is ONE. You are only a SHADOW ON THE WALL OF A CAVE until you LEAP UP OFF OF FLATLAND. Then JUMP INTO THE NEXT DIMENSION.

(Remember the pictures in the earlier: SECRET of Alphabets section)

The letterforms are memory’s wave guide angle index ‘cookie cutter pictures’ for tilting donut magnetic field domains from charge to charge COMPRESSION - which is energy into MATTER. They properly set the tilt or PHASE ANGLE - to get this (self-organizing thus self-aware making) compression going?

**HOW TO NON-DESTRUCTIVELY PREPARE TO ENTER TORNADOS - THIS IS THE ORIGIN OF SYMBOL!.**

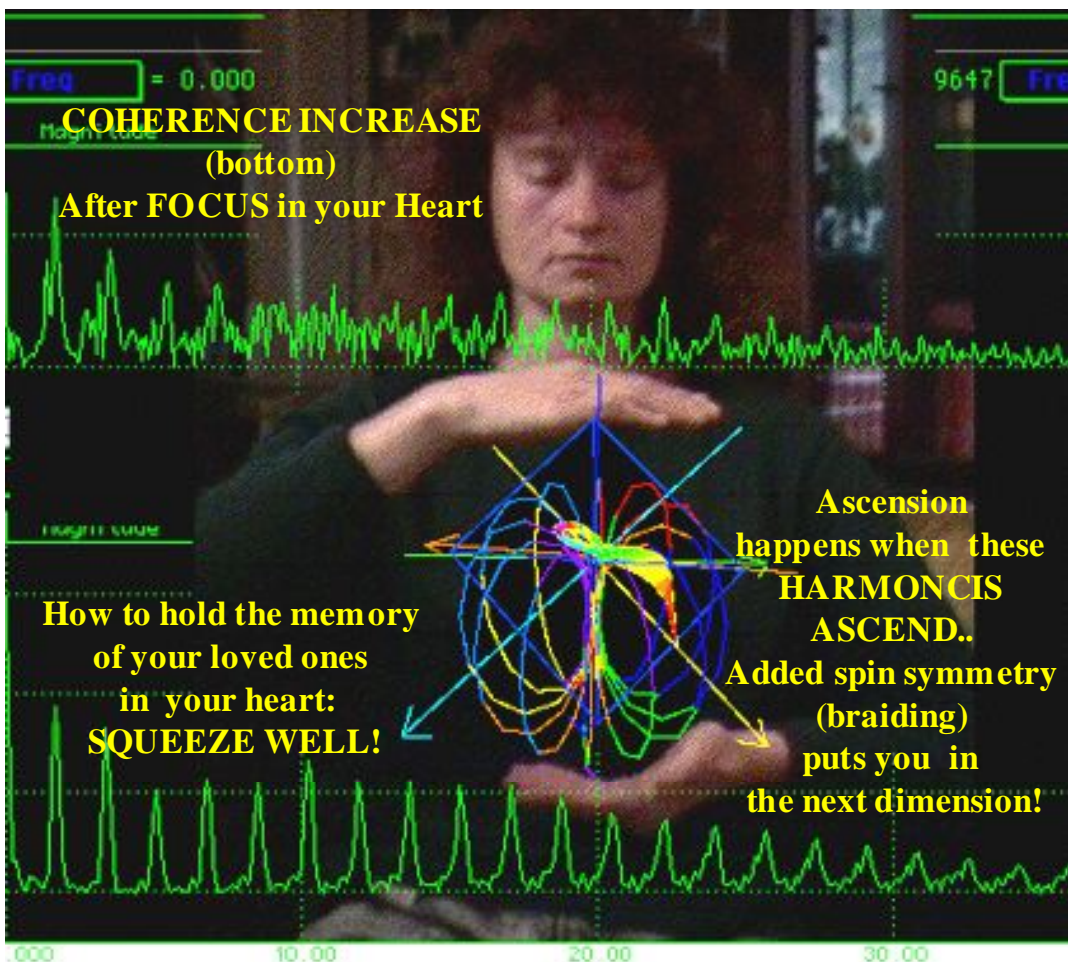
The origin of alphabets is the steering - the plumbing for how grab tornados by the throat by embedding yourSELF in them. Steering or aligning tornados (string theory and wormholes ) is the ONLY science and physics required to create matter out of light.

The universe consists of only THAT WHICH CAN BE NAMED - this means the universe consists of

only those DONUTS (field effect torus) which can nest next to each other NON-destructively.

The process of making a symbol in science - IS precisely the process of making a little picture INSIDE which is SELF SIMILAR - to the big picture OUTSIDE. Obviously - the ESSENTIAL DYNAMIC therefore of making a symbol - is designing PERFECT COMPRESSION. The math or perfect compression IS fractality - whose perfect solution is GOLDEN RATIO..

**The HEART is designed to help you get a HANDLE ON TORNADOS!**



**COHERENCE INCREASE (bottom) After FOCUS in your Heart**

**How to hold the memory of your loved ones in your heart: SQUEEZE WELL!**

**Ascension happens when these HARMONICS ASCEND..**

**Added spin symmetry (braiding) puts you in the next dimension!**

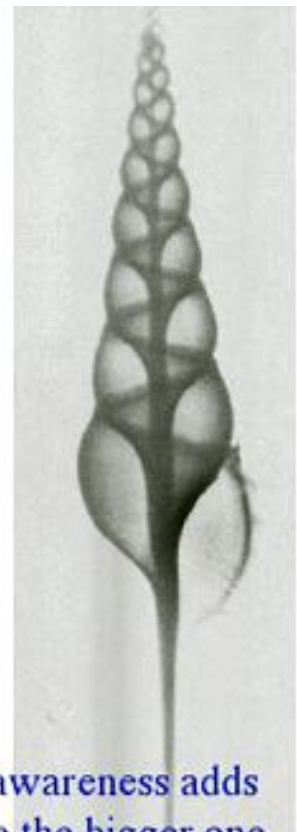
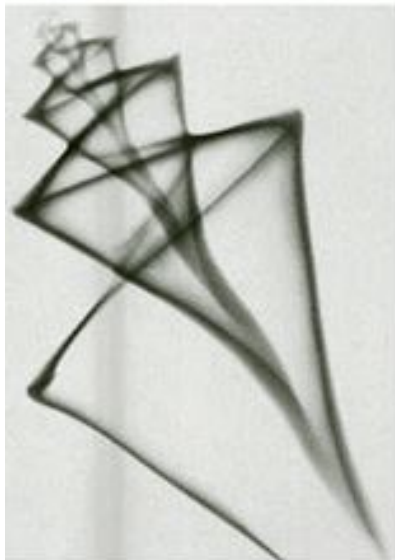


Compare this moment of trouble upon learning you were indeed steering tornadoes, to the problem of Rolling Thunder the Weather making shaman. Or compare it to my problem after years of intense kundalini, noticing that severe weather systems frequently appeared to follow my severe kundalini experiences. At first I was 'freaked out'. Later when I learned the physics, I became more comfortable with the problem of steering tornadoes like slightly dizzy pet animals. (It was only later I made the connection with how the Egyptian Amun Ra priests used the royal DNA of Tutankhamnon to regulate the timing of the flooding of the Nile). In "Weather Engineering on the High Seas" Trevor Constable noted the best orgone (conic capacitor) to trigger **the charge densification implosion** which **is precipitation or RAIN MAKING**, was the 60 degree implosion cone. (See the dodeca's nested into 12 cones picture of dimpling -next page.)

Any good meteorologist will tell stories about how huge 'killer' tornadoes actually appeared to intelligently steer around killing people. They clearly have an amount of self-awareness - which at some level becomes steerable.

I like these teaching stories about tornadoes for Feng Shui - Geomantic Dowser folk, because after all it WAS about a Dragon Current. It is just that in today's physics we substitute words like STRING THEORY, and WORMHOLES.. instead of words like VORTEX and TORNADOES. Remember physicist David Peat inviting Australian Aboriginals to Physics conferences (Canada) to compare their SONG LINE stories, to the latest physics for WORMHOLES and STRINGS.

The ancients KNEW that the power of human attention or awareness or focus, when 'squirted' into the center of a little tornado (song line) is what kept it CENTERED in the middle of a bigger tornado.. The Sufi: Doris Lessing ('Sirian Experiments') called this LOVE sticky glue: THE SUBSTANCE OF WE - FEELING.



**The "Centering Force" which self-reference, self awareness adds  
Is that which holds the little tornado centered inside the bigger one..  
The relationship between consciousness and that which fabricates gravity  
Is intimate.**

This **WAVE GENERATION OF CENTERING FORCE** by **TRAINING WAVES TO SELF-RE-ENTER**  
— **IS the role of Mind among waves , and the way self-similarity of charge waves 'implodes'**  
**centripedally into what physics calls gravity.** (Fractal capacitors/ 'condensers' are the only way charge waves constructively add and multiply their wave speeds -turning compression into acceleration - making a drain hole thru the speed of light - called Gravity.)



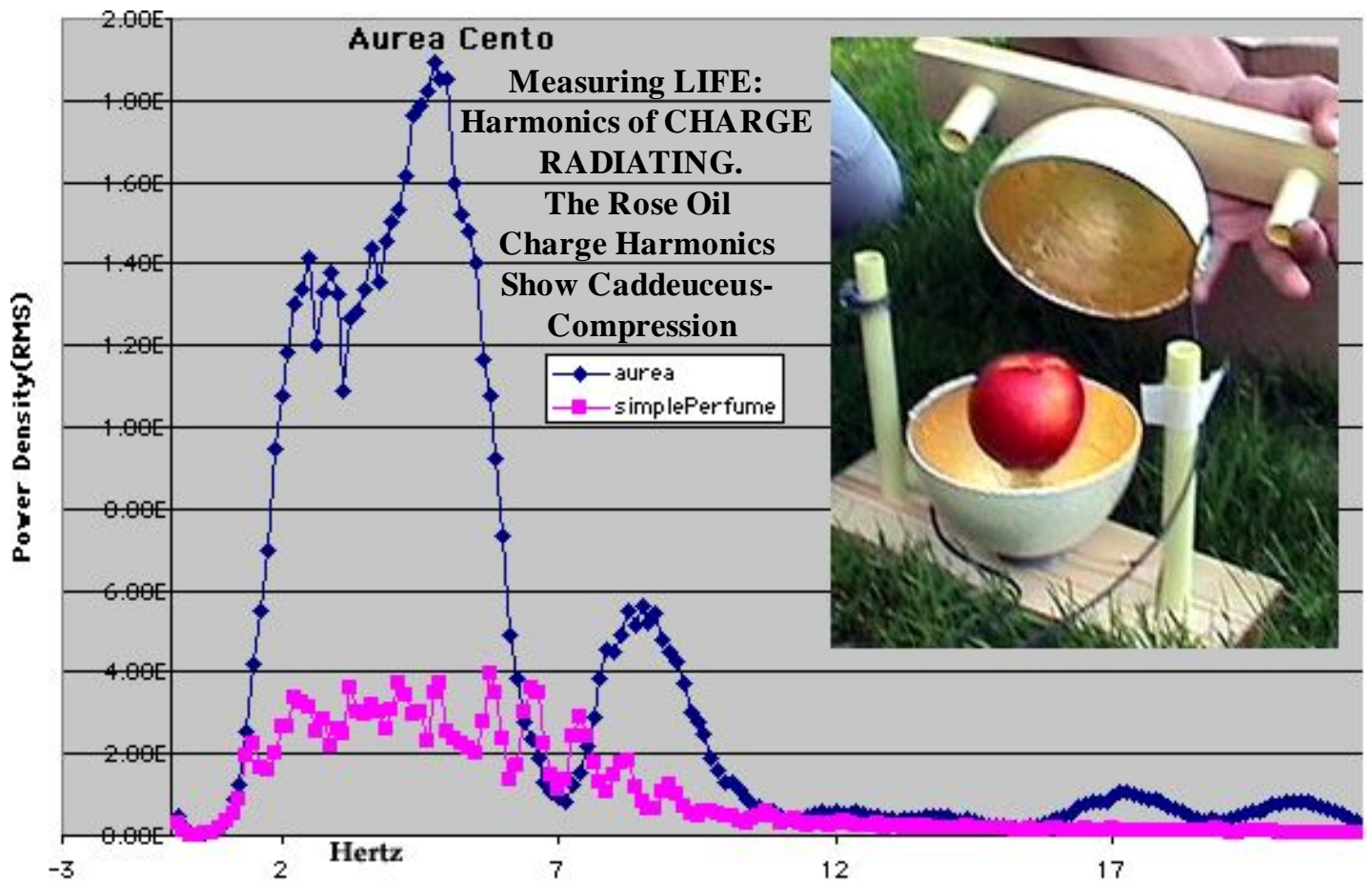
Above: "ANGEL TRUMPETS": 12 of 60 degree light cones - nested correctly in the symmetry pattern of nested DODECA-hedra: IMPLOSION. This angle was found best by measurement **to allow capacitors to make rain.** (Trevor Constable:"Weather Engineering on the High Seas") - Science met Wilhelm Reich's orgone and discovers capacitors communicate with clouds! Orgone was a primitive term for how to focus capacitive charge like a LENS. "When we learn how capacitors communicate - we will better understand how trees talk - and the physics of astrology." Wilhelm Reich's "Function of the Orgasm" was not well informed about ORGASM (charge release). Altho ORGASM can help prevent cancer - conserving that charge carefully at times - can pressurize the squirt gun of bliss juice to good tantra and kundalini and lucid dreaming.

*"All Human Interaction is About CHARGE" - Celestine Prophecy **LIFE FORCE Consists of the Ability to Attract & Self-Organize CHARGE** - This is Measureable Since Charge Becomes a "Fractal Attractor" / "Implodes" -when the Harmonic's Enter the Ratio of Self-Similarity - SuperLooping - or Perfect Nesting.*

*We measure LIFE FORCE as Self-Organization of Charge: Measure Internal COHERENCE, Step Two: Measure for The Golden Mean Ratio in the Musical Fundamental of the Charge Harmonics Presenting a radical new physics for WHAT IS LIFE. - Picture next page..*

*"Paying your debt to Gravity" is to embed..."The proportion of charge recursion below you vs above you is the amount of gravity (wind of charge?) you feel."The amount of gravity created in an atom (or ANYTHING) is in proportion to the relative amount of SELF-SIMILARITY (Fractal Embedding) between it's inside (nucleus) to it's outside (electrons). This is what facilitates the permissive collapse thru light speed by recursion - which tornado connects the our inertia below light speed to the intelligent gravity metabolism of star systems solving the incomplete 'fall to chaos' entropy idea of thermodynamics.*





*The fundamental mistake was not to understand the SELF ORGANIZING vortex geometry of compression making the connection BETWEEN scales (scalar / torsional) . A human fabricates gravity in their EKG and DNA by learning to steer waves into this painless (non-destructive) compression: known by the psychological name COMPASSION."*

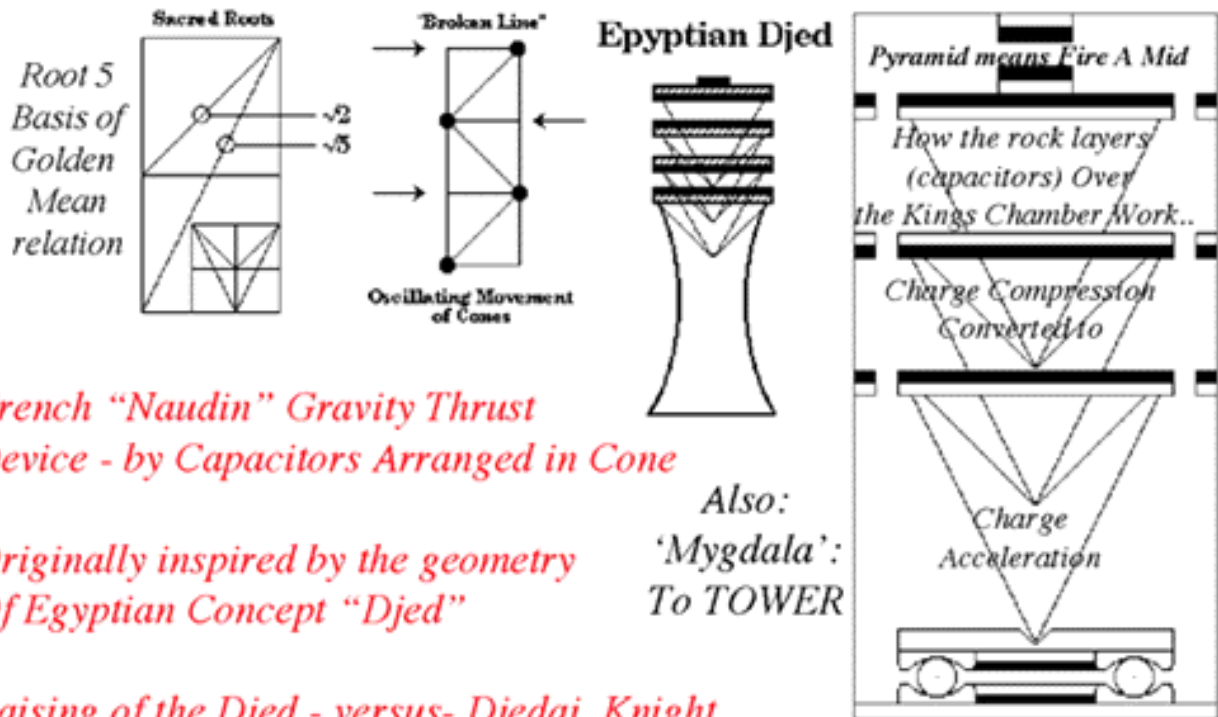
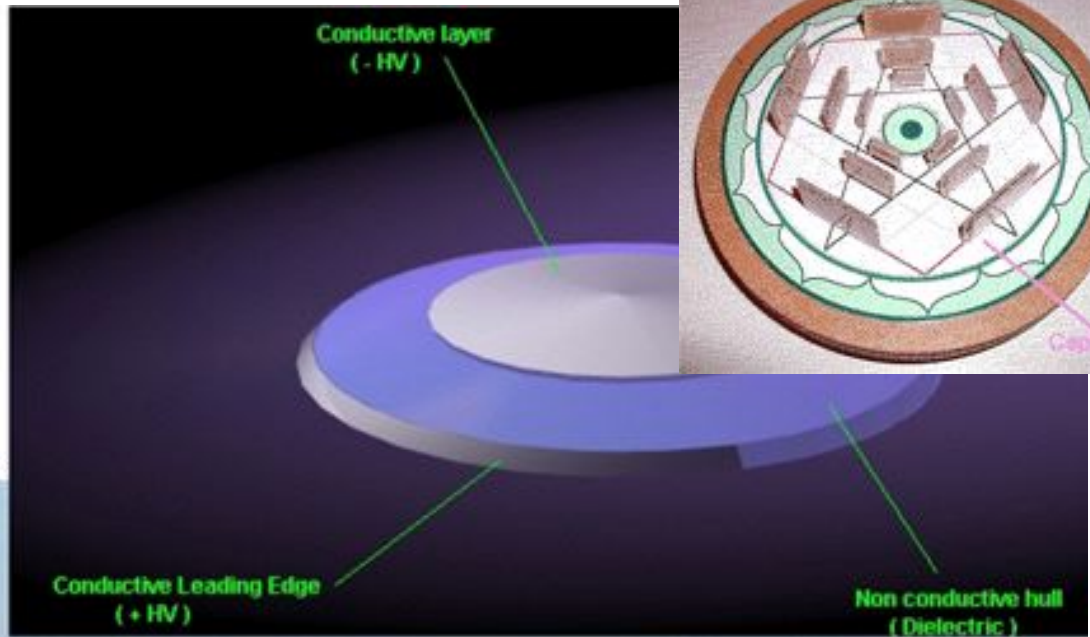
*Grounding is the same symmetry operation in electrical theory as it is in psychology: your wave inertia (information) getting access (embedding in ) the LARGER fractal (environment)." When Einstein commented that a magnetic monopole (wormhole) WAS the relationship of gravity to charge (in compression)- he foretold a clue to his own dilemma: WHAT IS THE GEOMETRY OF INFINITE COMPRESSION? He knew THAT geometry WAS the connection of electromagnetism to gravity.*

Faraday's observed that: **'Electrical capacity is to gravity as inductance is to magnetism'**. ....If Farady is correct then **the energy stored in the capacitor is in the form of a GRAVITATIONAL field**. Townsend Brown also found in charged capacitors that **weight reduction only occurs when the positive plate is upside to the negative plate**. .... **If the negative plate is above then the device increases in weight** . Dan Davidson et al then observed that the AMOUNT of weight change is greatest if a SMALLER CAPACITOR is nested under the larger!?! The obvious next experiment is to nest capacitors in the (Golden) ratio of recursion/embedding, to PRODUCE OPTIMUM CHARGE COMPRESSION & THEREFORE THE GREATEST GRAVITY!

Capacitors in Phi array - produce 'ion effect') In other words, **no 'rocket scientist' is required to solve the unified field, merely understanding the geometry of compression**. It stands to reason if you compress charge you store the inertia of that charge, which physics then calls 'mass'. . What they missed was the way waves used PHI recursion to send a portion of that inertia thru light speed at the implosion center, to produce the magnetic monopole which was Einstein's name for gravity.

**Why should you choose to understand unified physics? Because understanding how to embed yourself into that vortex wormhole tornado, is the role of mind among waves (why MIND inhabits PHIRE)**. Physics til now has not even bothered to ask why people lose weight measurably at the instant of death, or why radioactive half life is measurably reduced by focused human attention. In both cases restoring the charge fractality keeps a little tornado vortex better centered in a bigger tornado. That centering force IS gravity, and IS the proof that attention IS the creation of charge implosion.

Searl  
/ Townsend  
Brown  
Gravity  
Thrust  
Effect  
Created  
by Curved  
Capacitance  
Measured at  
JL Naudin Labs



*French "Naudin" Gravity Thrust Device - by Capacitors Arranged in Cone*

*Originally inspired by the geometry Of Egyptian Concept "Djed"*

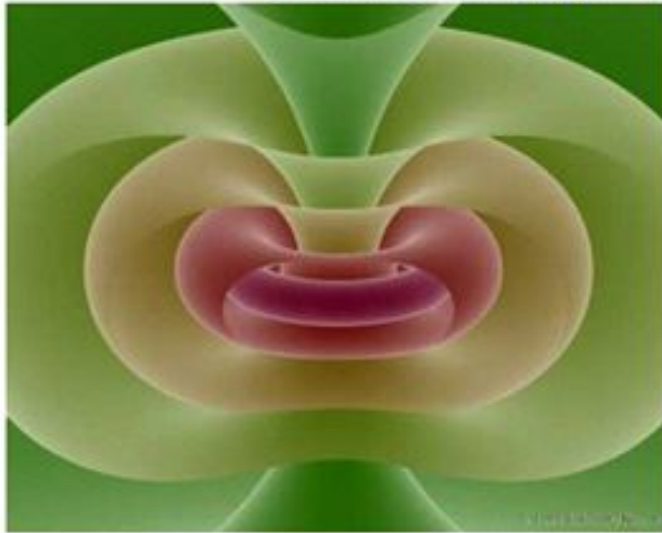
*Also: 'Mygdala': To TOWER*

*Raising of the Djed - versus- Djedai Knight..*

*Compare to Sword and the Stone... Creating ~Vertical Component To Magnetism originally in rotation.. (Golden Ratio Path - Translates Vorticity from Circle to LINE..)*



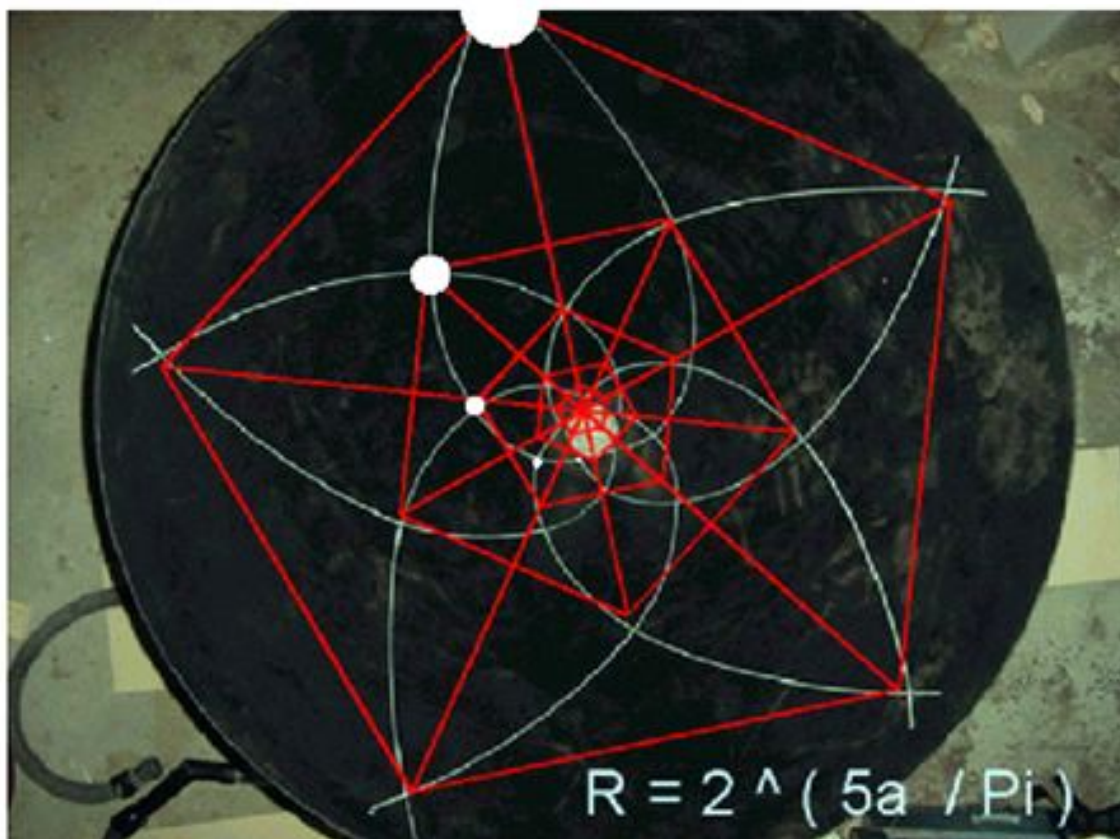
By design & by braiding, capable of so much self-similar  
 implosive compression:  
 DNA SQUEEZES biological magnetism  
 Thru the speed of light into GRAVITY WELLS..  
 Fabricating Gravity.. As the geometer of consciousness it's  
 Symmetry inserts the embedding which keeps little tornadoes  
 Nested inside bigger ones...



Thus consciousness as embedding  
 (self-reference) maintained  
 Becomes the physics of the GLUE  
 Which holds fields together.

*Science shows..  
 Love is the GLUE  
 That Holds things Together*

Infinite Non-Destructive Compression - because of recursive adding and  
 Multiplying of wavelength AND velocity - PRODUCES the acceleration  
 Einstein knew is identical to gravity.  
 Cone over 1 meter wide, set up at the correct 60 degree  
 Dodeca embed stellation angle to accurately position capacitors  
 To fabricate gravity from voltage, and the reverse..



Ok, so finally you got it: It was knot about proving anything to anyone, it was about understanding wormholes so well that when the chips were down, you would be able to throw your weight around among tornadoes. Because, after all - tornado vortex seem to be the stuff matter is made of - and how mind steers matter!...

**“Cooking Up the Atomic Table by Tilting Vortex Donuts into Platonic Symmetry: Chemistry’s Atomic Valence Electron Group Table Map seen Clairvoyantly (Occult Chemistry)”- pictures P.16-18.**

and so if you want to get leverage among these twisters, you must be prepared to gather your inner tornado and embed it into the outer one - in order to become immortal / sustainable.

Let us apply all this tornado steering skill, to your average dowser. Suppose you are the fixit dowser called in just after the expensive well driller just missed the water vein by a few inches. (Maybe the previous dowser did not account for the tilt of the drill bit. I remember David Yarrow instructing the drilling rig operator pointing his finger at a certain angle as the bit hit the ground.. ). Your average dowser upon being charged with the task to MOVE an underground water veins, gets out his hammer and rods and begins banging the sonic piezoelectric of the underground conductivity geometry - very much like a somewhat klutzy acupuncturist. You are correct to assume, that **-Water follows Magnetism follows Conductivity, follows Symmetry .. BUT** in order to efficiently BEND that line, you need to finish the KOAN. **Magnetism follows Symmetry follows Embedding follows AWARENESS!**

This follows from the Sufi wisdom: **Only LOVE (Embedding) bends the Light - Therefore only LOVE Creates!**. This is because **long wave phi ratio (lo phi) embedding creates the implosive vortex that bends the wave (light) from the line (energy) into the circle (mass happens when waves store inertia - the gyroscope effect).**

So let us be more ELEGANT . (El’s are ones who can make the EL phase shift turns of mind from the circle to the line... Accelerating in the process from attending to the node - mass - to attending to the WAVE -energy - which gave birth to the wave node.) The ELEGANT dowser enters the Earth (grid diving) penetrating the magnetic centroid of his attention as field effect, until by compassion embedding becomes the center of gravity of the water vein, and persuades the water vein, why more service will happen if it bends. This seemed all very theoretical until one day in New England I stood next to Marty Cain and watched her do it.

([www.martycain.com](http://www.martycain.com)).

Lightning is knocking at the door of your tail bone (tantra and kundalini) saying :”Do you know how to steer tornados yet?” If your answer is yes, you KNOW the symmetry skills to ‘slip knot’, then maybe YOUR kundalini bliss juices will compress non-destructively into charge compression (something less informed people call INTELLIGENCE). Otherwise, you get to go to the place which the ignorant American Medical Association chooses for kundalini patients - the schizophrenia ward. THIS begins to suggest why PURE PRINCIPLES of SCIENCE can help your average Dragon Current swallower- dowser (geomant).

As a dowser, you understand that the skill to FEEL a magnetic field INSIDE yourself, is absolutely SURVIVAL RELATED for all humans. Because the ability to steer magnetism starts with the prehensile notion of FEELING it. Just like the Sufi or Gurdjieff sacred gymnastic teacher tells you : **NO BLISS DANCE INSTRUCTION FOR YOU - until you can put your ATTENTION into the tip of your little finger with enough force that you generate a little tingle or presence there. When you can FEEL the result of the palpable motion of your own (implosion making) attention - as a wave - THEN you are ready for ecstasy dance.** Your sacred gymnastics instructor is wise

Step Two: Is sorting out what parts of Science ARE Pure Principle, and which part is schizophrenia (separateness instead of oneness).

**The bad and useless (death producing) parts of Physics & Science - ideas which need to be thrown out:**

1. **error: “Matter is separate from Spirit or Soul or Energy”**. Matter is merely successful compression of charge or energy to the point where the amount of gyroscopic inertia becomes ‘measureable’. The REASON  $E=MC^2$  is because obviously energy gone in a circle CREATES mass. The more profound insight is CHARGE arranged in a fractal CREATES gravity. The MASS created by INERTIA is proportional to the self similarity of the inside to the outside of it’s wave pattern.



**2. error: “The 4 Fundamental Forces (Gravity, Electromagnetic, Strong & Weak Nuclear forces) are SEPARATE”.** They are completely connected in a UNIFIED FIELD. Soon Physics will get over its childishness to realize there are ways to describe the perfect symmetry which permits wave inertia to move BETWEEN frequencies COHERENTLY - other than imprecise words like SCALAR and TORSIONAL. Then when they perceive charge being ACCELERATED in a cascade between VELOCITY harmonics arranged in a fractal: the magnetic monopole and gravity’s connection to charge will be understood. (A magnetic monopole happens when charge implodes thru light speed causing the suction of gravity-eliminating its opposing pole).

**3. error: “Science consists of PROOF”.** The only proof any wave or person or equation ever needed to become immortal, was the self-evident symmetry which allowed it to persist / sustain / become immortal. That is the charge self-organizing nature of life force itself. In a sense, if you walk into an argument of physicists with absolute twinkle and fire in your eyes, brimming with life-force and irrepressible awareness — You have without uttering a word absolutely condemned those fools sitting in front of CRT’s zapping their auras, eating dead food, inhabiting charge bleeding square metal structures. You win the argument by merely choosing the hygiene of life force, about which they have not a clue. The only physics you need, is the physics which makes YOU self aware enough to BE. However that DOES require a language of absolute precision. That language is PURE symmetry and PURE principle. This is where the origin of alphabet and symmetry emanates from.

*The Hebrew alphabet forgot all symmetries above the tetra, because it was all the machine code required for the hive computer of the ashtar borg hive mind. (Yalweh / Enlil the parasitic reptilian side of the Annunaki Draco Nephilitic family). The Ophanic (Golden Dawn) alphabet (Movie: “StarGate”) used the superset hypercube dodeca ( [goldenmean.info/orion](http://goldenmean.info/orion) see bottom) because this is a machine code (bubble memory toroid field retrieval in 3D is true alphabet shadows) whose field effects self organize into distributed instead of hierarchical self awareness. (Try taking the word **hierarchy** from Jim Hurtak’s Saraphic language for example).*

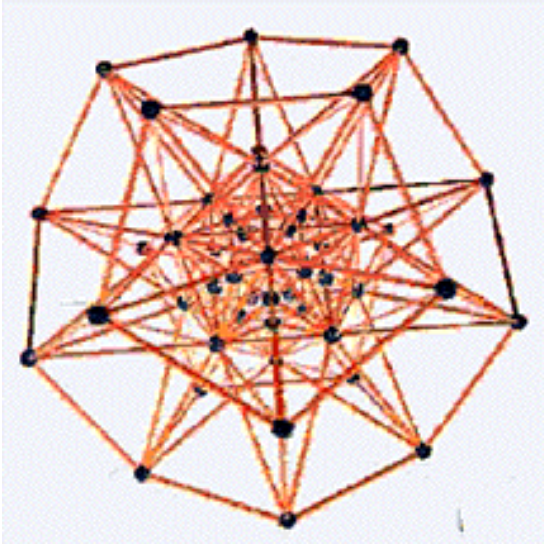
**4. error: “DNA is simply a tool to sequence CODONS to replicate proteins.”** This idea is a LIFE THREATENING MISTAKE. DNA is a device for making the field effect necessary to compress CHARGE thru the speed of light, enabling biological memory to become immortal / sustainable. **Soul happens when recursive braiding implodes a SUSTAINABLE tornado thru light speed up the long ‘zipper’ axis in DNA** - see: [goldenmean.info/decode](http://goldenmean.info/decode) The propagation of the ENSOULING and GRAVITY making field effect, enabled by DNA based implosive structures is obviously its function. That is how even the astrophysicist’s daughter WILL inhabit stars, if she get’s the privelege of living in a charge feeding atmosphere (hygiene for life force). This in spite of the fact that current astrophysics does not have a clue - how stars GET inhabited - because they don’t know how DNA and human aura’s MAKE gravity.

Describing replicating proteins as the REASON for DNA is oversimplified. The PURPOSE for MACHINE CODE in computers, holds more INTENT than just storing PLUSSES and MINUSES. The Codon sequence is not even the programming language. Just because you get a clue to what machine code is in computers, does NOT mean you have a clue to what language it was programmed in. C++ is a braid on a braid, a language superposed on a language. That is how BRAIDING programs DNA. It implodes a field effect. (Book: “Grammatical Man - Information, Entropy, Language and Life” : hi signal to noise ratio in DNA informatics = CONTEXT DEPENDANCY - hint: “braiding”). Of course since **your average genetic engineer does not even know or care that DNA MAKES a field effect - much less how that field becomes faster-than-light to lucid dream and carry memory thru death (compression) . That genetic engineer is perfectly happy to take the soul out of your children from the scrambled genes (no-braid-implosion) in the corn and soy they got for breakfast.** And if YOU also do not know or care - then you too may find it ‘a privelege to be assimilated’.

**5. error: Words like INSTINCT and ZERO POINT and SCALAR and NON-LINEAR & even GRAVITY are words to INFORM YOU ABOUT PRINCIPLES in SCIENCE . More the truth- these words are used merely to dangerously hide TOTAL IGNORANCE!** Scientists use certain words which YOU should translate to mean; **“I - the scientist - am putting this word in here, because this is a place where I am so afraid to say I DON’T KNOW, that I can’t even imagine myself asking the question needed”.** Words that fit this category generally include: INSTINCT, SCALAR , ZERO POINT, etc. When you hear a scientist use words like this, you could do well to advise them that if they were BRAVE enough to substitute the words **“I DON’T HAVE A CLUE”** - at least it would help them admit there was an unasked question. Take the word GRAVITY as scientists use it, for example. They think, that because they have been able to measure it’s relative pulling power, (called

acceleration), they understand it. When in fact, they have NOT A CLUE, what the pure PRINCIPLE is. **The reason no one is allowed to even ASK science WHY an object falls to the ground - is because no one is BRAVE enough to EMBARRASS THEM!**

The PRINCIPLE is that fractal and self-similar charge compression turns compression IN to acceleration. This is where inertia goes thru the speed of light. Understanding GRAVITY's attraction is as easy as watching the suction down the drain in your bathtub. Pull the plug to allow charge OUT thru the speed of light (give charge a way to accelerate by recursive constructive interfering adding of VELOCITIES) and you MAKE gravity from charge. This single insight alone - replaces fossil fuels- and enables out genepool to take our rightful place - metabolizing and digesting the gravity blood of stars. Planets experience gravity relations erotically.



Naive scientists do not have even a hint to WHY infinite compression and acceleration (Einstein's equivalent to gravity) are identical. (Waves recursively heterodyning by PHI ratio - like capacitors arranged into a fractal to make gravity - recursively add wave lengths AND velocities.) Einstein knew infinite non-destructive compression was the key to relating CHARGE to gravity.. he simply did not understand the geometry of perfect embedding / recursion to make this possible. (pic)

**Left: infinite scale invariant compression, allows charge to implode - thru light speed - suction out that dimple - is called gravity. Arrange capacitors like this (orgone - or the valence of gold) - and you make gravity.**

The problem is, that everytime you use a tool WITHOUT knowledge of it's pure principle, you join the **BORGS - the DRONES - the DROIDS** . (The ones without bliss and therefore without SOULS.) So you **DIE** a little, every time you let a physicist sell you the absolute LIE that all energy transactions move toward **CHAOS (entropy)**. That physicist has **NO CLUE** where the urge to self-organization emanates thru **IMPLOSION** - the speed of light wormhole connector. (The spherical capacitor can measure ether, life force & ensoulment [goldenmean.info/biophoton](http://goldenmean.info/biophoton)). Your CIA does not want you to know that capacitance focuses like a lens (orgone) which becomes gravity - because that would make the billions invested in radar hiding technology wasted. **Yet focusing charge like a lens into the dimple which self-organizes is the very ESSENCE of feng shui / geomancy. FOCUSING CHARGE LIKE A LENS IS NOT ONLY THE KEY TO MAKING ALL MILITARY SECRECY OBSOLETE - IT IS THE KEY TO THE CONCEPT OF SPIRIT and HEALING and MAKING SACRED SPACE and HEALING WATERS! (&making LIFE).**

(More detail here look up "amenti principle" for the acceleration of soul groups bliss like wave pods thru light speeds into the gravity worms which steer stars in [goldenmean.info/amenti](http://goldenmean.info/amenti) )

—However there are some physics and science you DO need:

1. Language capable of precision and detail (infinite multiple connectedness = fractal). Science calls this "replicability". It is important in context, because perfect symmetry is what makes waves and ideas and people infinitely shareable. This is how you will steer lightening with a quick enough response time to make it up your tail bone without cooking you. (Heat is merely a measure of the opposite of non-destructive compression). This cooling fearless non-destructive compression hygiene, is also the physics for survival of the solar maximum's (2005-2012) compression wave designed to test which DNA can compress enough to steer stars, which Christian's have foolishly been calling 'rapture'. Ecosystems and hearts which are not fractal will exhibit heat.

2. The word PHYsics, means literally the science of the cycles of PHI (Let's get PHY-cycle). This is pure principle. Science means literally: "to love to know", or "to know to embed".

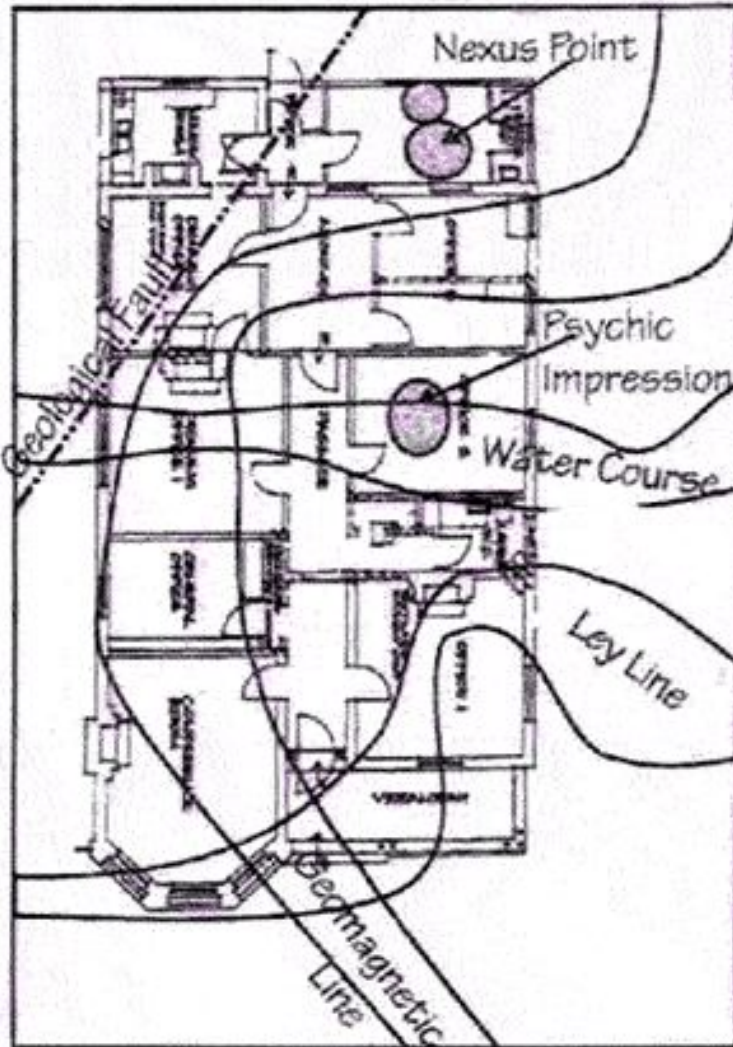
3. It's OK to use words like voltage and amperage and shortcuts to mean AMOUNT OF PRESSURE, versus AMOUNT OF FLO, in a universal compressible (like waves in air) background medium (ether) - as long as you



don't forget - YOU HAVE NEVER HAD THE PRIVILEGE OF NAMING A SUBSTANCE, BECAUSE THERE IS ONLY ONE. What you have called naming, is the process of labeling shadows of the different possible SHAPES - of waves of pressure moving about in that universal substance. Once you can feel how MIND - by inhabiting PHire - can arise out of that universal 'jello' like compressibility - You are then closer to knowing the DOWSER's role as MIND AMONG WAVES.

We are shortly here going to translate these ideas into a new definition of success for ARCHITECTS- HOW TO MAKE LIFE FORCE IN STRUCTURE ...

But first: some practical and measureable examples for our dowsers... :



Remember- **FEELING** is a name for the ability to **PERCEIVE** and **STEER** **MAGNETISM!** Without this simple ability to **FEEL** a magnetic line - there is no hope of

1. Dowsing
2. Steering at death or lucid dream
3. Bending an energy line to your wish
4. Learning to **SHAPE** healing energy.

**SO** - in summary it is critical and essential - you **MUST** train yourself to **FEEL** magnetism. Because without that - there is no **FEELING!** You don't **WANT** to be without **FEELING?** So too- you don't want to **NOT** be able to **FEEL** magnetism. It **IS** the wind on which love travels. Fortunately - almost anyone who gives themselves a chance to get quite inside - and **FEEL** - can sense a magnetic field. The **KEY** to dowsing - is to refine this sense - and learn to ask your inner cellular response/intelligence - increasingly **PRECISE QUESTIONS.**

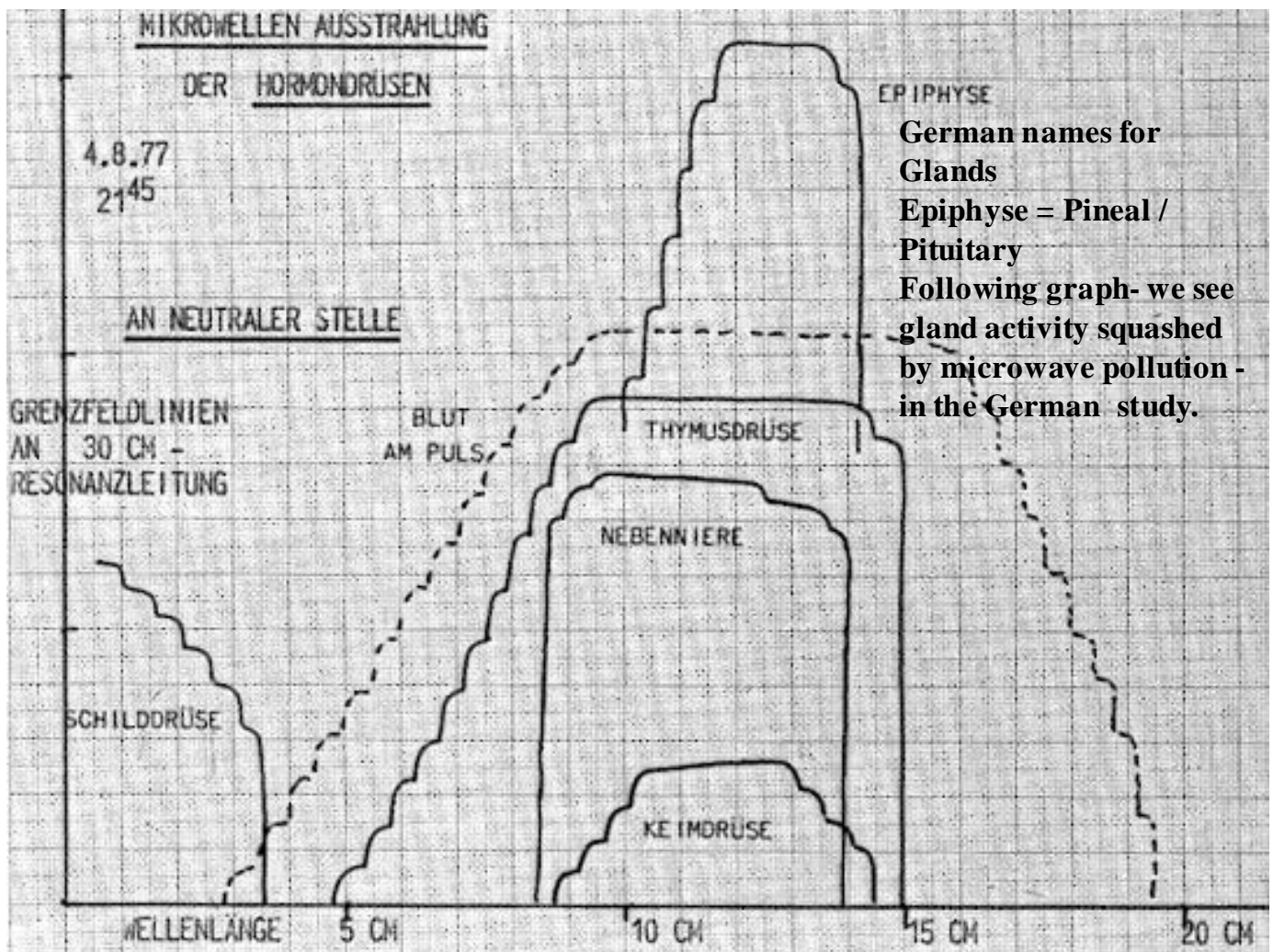
[Picture: Geopathic Stress In Our Homes , by Kevin Masman](#)

When I first saw [Bob Dratch](#) demonstrate his microwave mapper on the spine emanations of magic lady Wendy Thacker, I had no idea the CIA was about to declare it a threat to national security. (Bob has been legally prevented from telling you this, that order doesn't technically prevent me from doing so. ). After calculating the common wavelength for all biological energy transactions in the cell (the ADP to ATP quantum leap) he built a high gain scanner to map that in the microwave. That was a map to the real time geometry of biological fire (metabolism density) in the body. With his nice 3D computer interface to the mapper, hospitals were drooling. After he made the map of her spinal microwave, he described her lifetime history of where psychological trauma landed in the body, by looking at the graph. When he finished, she was weeping.

What is relevant to our budding geomancers, is what he did next. Stepping out into the yard, looking down at a landscape expanse, he showed us that by scanning the horizon, he quite clearly now had the **ULTIMATE DOWSERS TOOL.** Simply put, what we had been calling ley lines, were clearly wave guides symbiotically conducting the info density of biological cellular microwave - like a blood stream.

In America - you can test the microwave density of ley lines by how quick a CIA black helicopter shows up after you bang a heavy metal stake at the (quenching) cross of major energy lines. That is not only living cells info bloodstream, it is the CIA's communication blood as well. Trouble is, they are not sharing the bandwidth wisely. It is similar to the Navy forgetting to tell the weeping whale savers at a mass beaching, where their most recent underground LFAS lo frequency acoustic sonar just blasted the life out the the whale families sonic pod or cocoon. The CIA and military intelligence (look up: oxymoron) - use native sacred sites for microwave antenna's because symmetry is what makes sites SACRED - because symmetry is what makes sites electrically conductive.

For the below we thank: "Dr. Saskia Bosman" <sothis@euronet.nl>, Culemborg, Netherlands.. for more info on the PINEAL gland as the steering imploder for biological magnetics thru light speed - readers are encouraged to study her contribution to : [soulinvitation.com/pineal](http://soulinvitation.com/pineal) also you may go to Dr. Saskia Bosman's Research web site directly: <http://www.spiralsofevolution.nl>

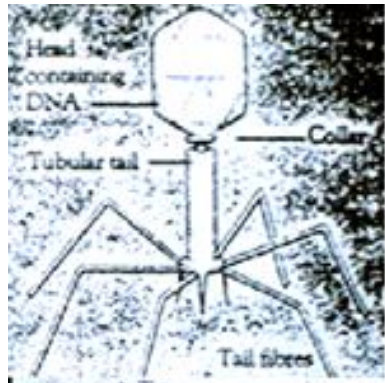


GlandsInNormalZone.jpg: (Above) Horizontal axis: wavelength in cm., Vertical axis: threshold lines at antenna length 30 cm.

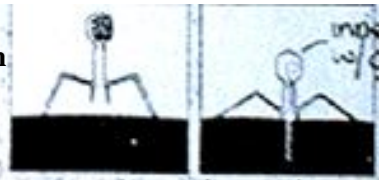
Curves: Left: thyroid gland Right, from bottom to top: sex gland, adrenal gland, thymus gland, blood at wrist, pineal gland (top).

Translation of caption: Fig. 3 (p. 25) **Intensity spectrum of the spontaneous microwave emission from the endocrine glands at a neutral site.**° (The threshold lines, as the outer standing waves of radiation at the resonance antenna express themselves as charge at a mineral plate).





The SHAPE of the virus is a clue to it's function to screw in and embed itself in a cell membrane - to allow it to SQUIRT it's DNA inside.

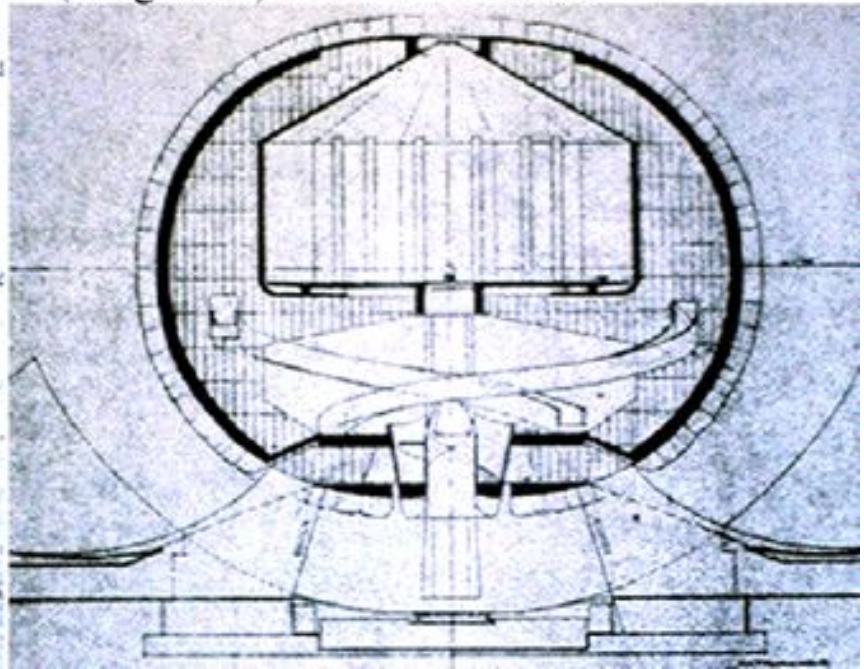


Compare the way the virus 'screws' itself by EMBEDDING

Into Membrane - with the way CATHEDRAL (here Aurobindo) gets access (ex catheter) to the (magnetic) Blood of Earth.

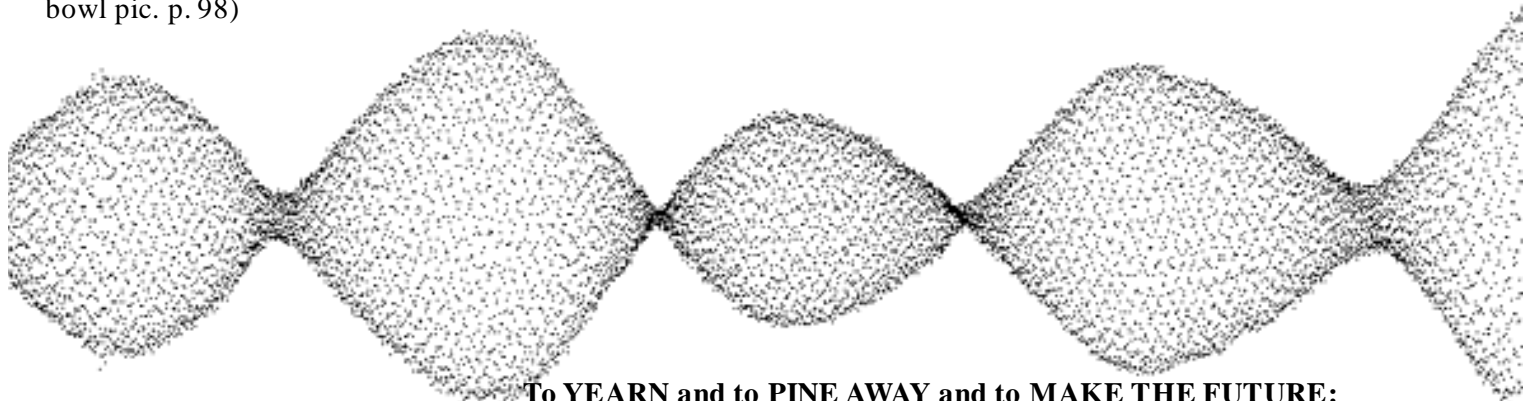


How the virus gets THRU the membrane..

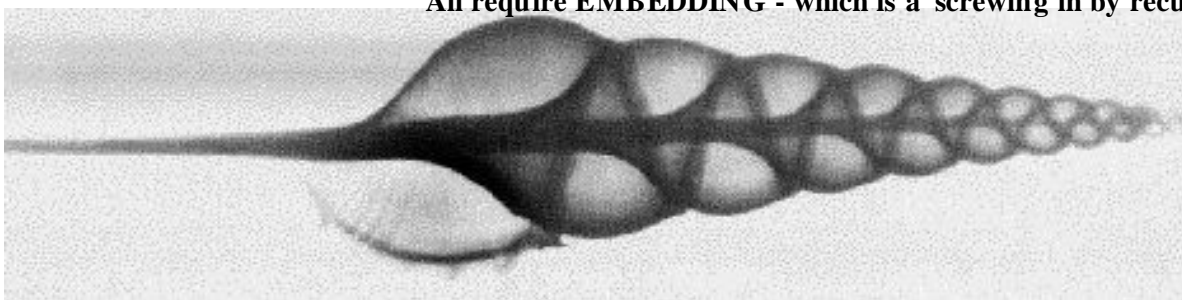


'Getting Screwed' - is not always a negative thing. Embedding is the mathematics for nesting a smaller structure into a larger. The symmetry which DOES this embedding DOES look like a screw. Not only does the PINE CONE, the PINE-apple, and the PINEAL Gland look like a screwing in...

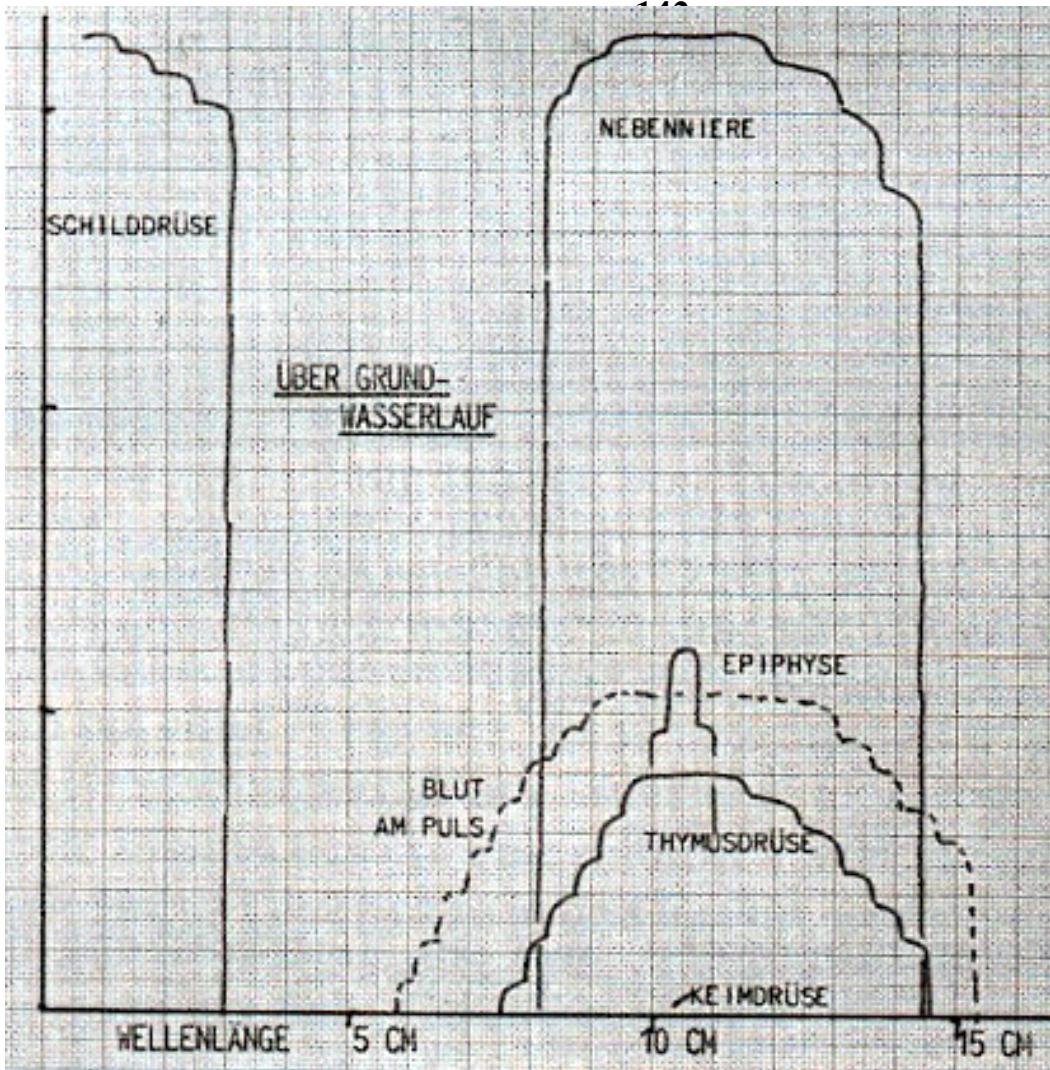
Notice how the sound sampled from a (quartz) healing SOUND BOWL.. looks the same! (similar to the Tibetan bowl pic. p. 98)



To YEARN and to PINE AWAY and to MAKE THE FUTURE:  
All require EMBEDDING - which is a screwing in by recursive nesting!







GlandsAtGeopathicZone.jpg: (below) Axes: same .Curves: Left: thyroid gland, Right, from bottom to top: sex gland, thymus gland, **narrow peak is pineal**, broad peak is blood at wrist, adrenal gland. Translation of caption: Fig. 4 (p. 26) **Intensity spectrum of the spontaneous microwave emission from the endocrine glands at a site, disturbed by an underground water course.**

Summary : **scrambling underground long wave magnetics, represses the microwave singing of the high pineal..etc.**

The microwave density of the nose tip as high frequency wave guide illuminates the biological wisdom of the eskimo kiss, and the witches twitch for example.

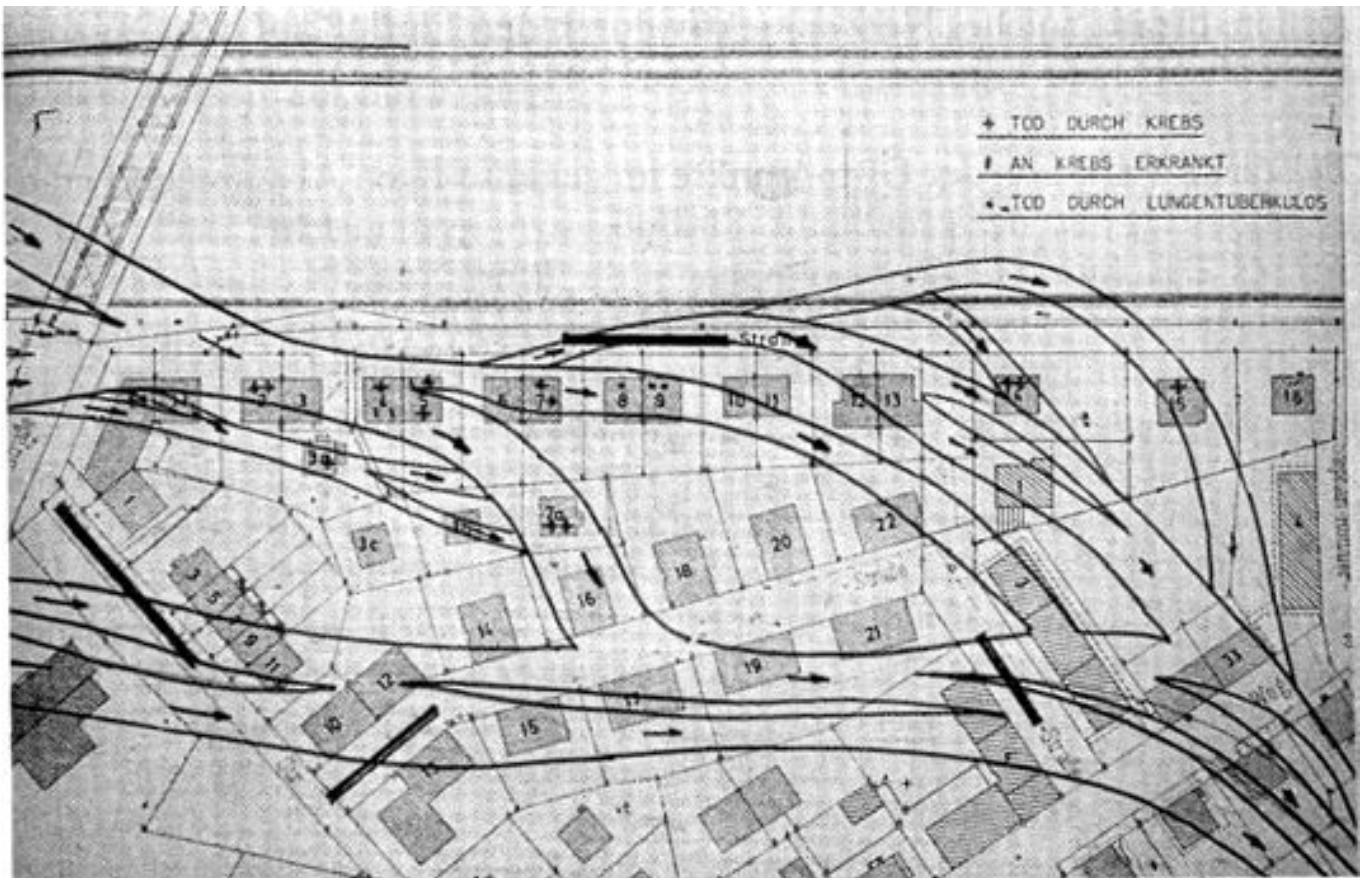
Insects navigate by microwave. (Phil Callahan). Olfaction ( pheromone) is a notching of infrared conductivity at a particular spectra. Your breath is a micro wave laser (maser) by which insects steer. Etchings on pyramid paramagnetic stone were microwave guides with strong ecological implications. The best microwave amp waveguide Dratch found was such an Egyptian etching.

Bioacoustic habitat theory - signature sound works - and "Structural Stability and Morphogenesis" for biophysics is nothing more than the music of how waves by nesting in phase keep soap bubbles and membranes and immune systems from popping.

Next page - the pictures of the underground water courses from the same Robert Endrös book: translation of caption: Fig 71 (p. 169), Residential area over powerful underground water courses. Since the making of this map another 4 people died of cancer. text in upper right corner, from top to bottom: **Death by cancer. Sick of cancer. Death by lung tuberculosis.**

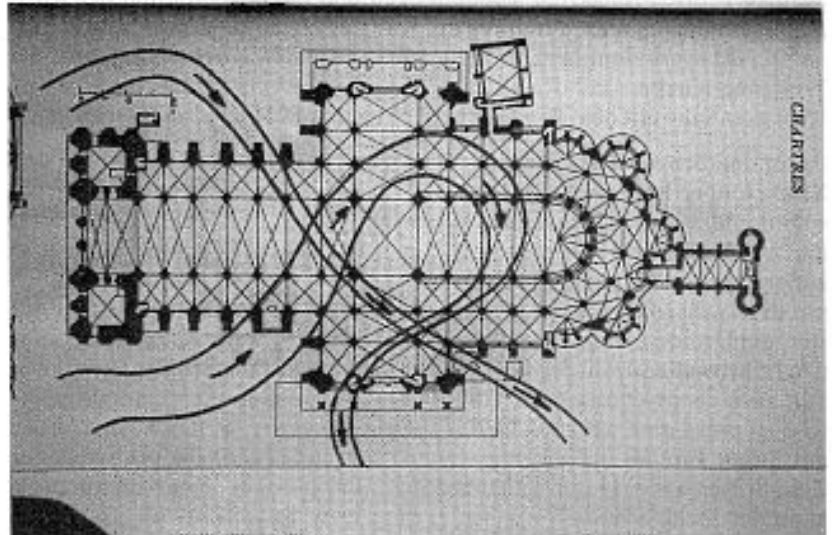


Water Veins Create Underground magnetic currents, which are linked to microwave currents which are measureable (Dratch et al.)



Mapping underground magnetics under Chartres.. Translation of Caption: Fig. 81 (p. 187) Chartres cathedral over underground water courses.

The Bob Dratch work measuring the underground magnetic currents, using microwave - suggests a connection between the ley lines and the effect upon the microwaves which the German research documented effected the high glands in the brain. I think of the pineal as a kind of steering wheel to surf magnetic lines .. even into the lucid dream and the bardo..



What does all this mean? It means your ecosystem is a nice song of these frequencies all woven non-destructively together in a braiding operation nature calls PHYlotactic embedding. ([goldenmean.info/philotactics](http://goldenmean.info/philotactics) ) Perfect branching call PHI is perfect compression - perfect unpacking is perfect packing... Computers are no more than a history of compression discovered. Biological immortality as wave sustainability is the same.

See also - the measurement of ley lines and song lines by simple magnetism map: Rob Gourlay Picture P.101.

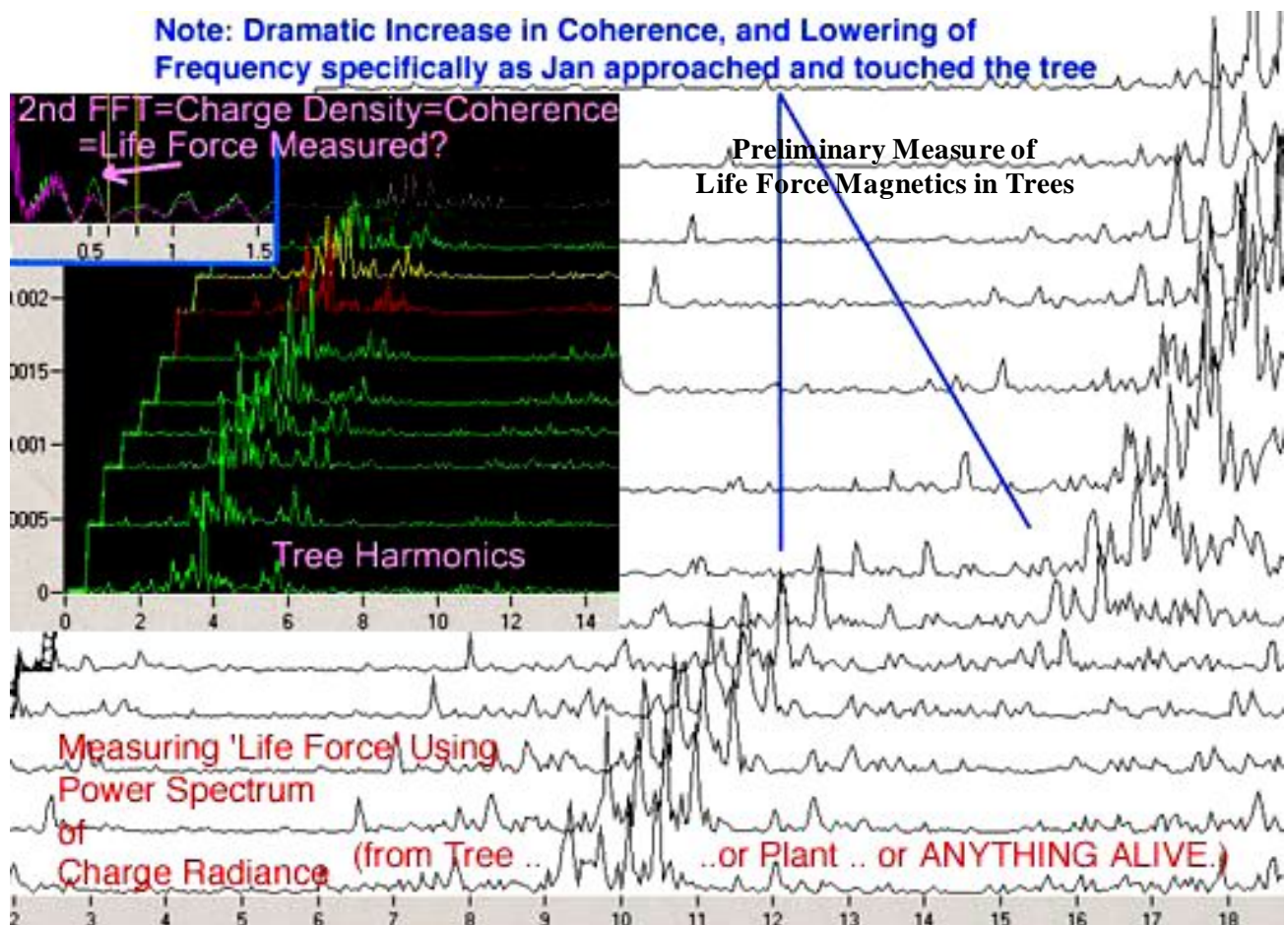
So where does this put out poor confused dowser feng-shui hired gun? It means, **she must learn to steer waves with her mind and heart directly. Steering those waves around requires nothing more than the skill to embed. This means screw yourself in to the center of gravity of the field effect outside you - be FEELING for it. Compassion - starts the COMPRESSION which puts YOU in the center!**

Grounding has the same meaning for electricians as psychologists - a perfect path to unpack into the pervasive self-aware electrical fractal. This is the practical explanation why bliss will drive you crazy unless your back yard is a magnetic fractal. ( look up [goldenmean.info/labyrinth](http://goldenmean.info/labyrinth) )

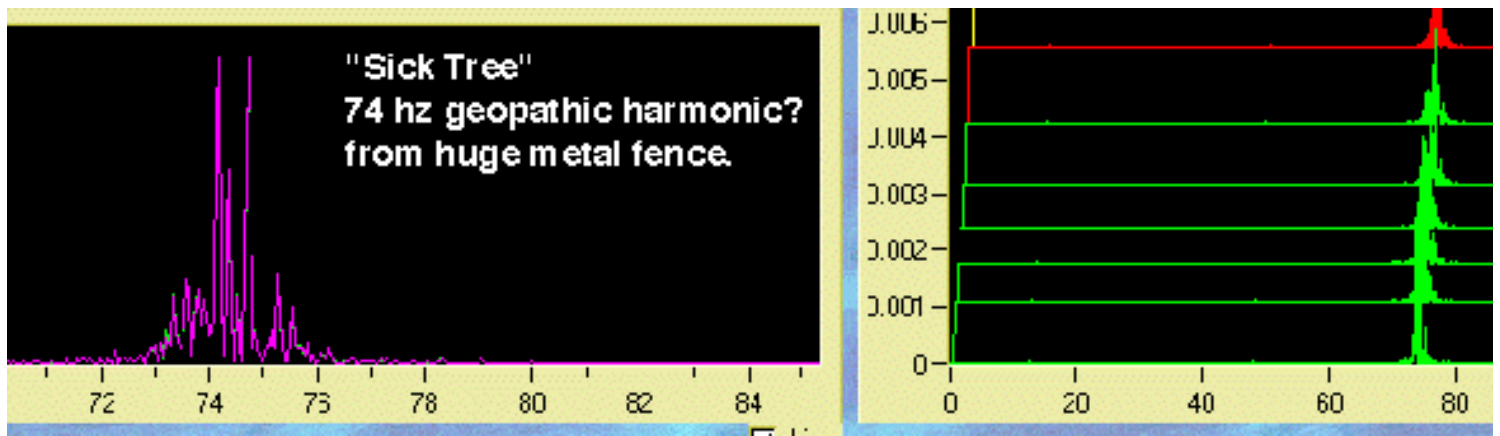
Now I would no more say, that LEY LINES ARE MICROWAVE, than I would say body acupuncture energy meridians ARE lo resistance paths - even tho I saw Pat Flanagan successfully measure meridians simply as paths of lo electrical resistance. Is the good SYMMETRY we call CONDUCTIVITY for DC, the WAVE GUIDE for Higher Frequency (microwave for example) information density? Clearly Yes. Is that ALL a ley line, or an acupuncture meridian is? Clearly NO! Just because DNA in blood becomes measurably superconductive and superluminal - ([goldenmean.info/superDNA](http://goldenmean.info/superDNA) ) does not mean we conclude BLOOD IS MERELY A WAY TO MAKE MAGNETISM GO FAST. It is that, but it is more - We might say blood is a name for when magnetic flow becomes intent rich.

So it is important for dowsers not to get confused into thinking by using some rods or pendulum, they have **measured** something. Clearly, by all descriptors of science (replicability and precision for example), they have measured nothing. However, when we correlate muscle strength (kinesiology) to COHERENCE in the EKG (as we recently did with the HeartTuner at Kinesiology college here [goldenmean.info/kinesiology](http://goldenmean.info/kinesiology) ) - that is a measurement. That brings us closer to rigorously describing the relationship of COHERENCE (in heart and mind), to GRABBING THE TORNADO - your muscle voltages - by the THROAT. Coherence in EKG goes UP when WILL has found what is shareable - electrically. Coherence is the body's lie detector - as it is the difference between life and death for all of biology. ( [goldenmean.info/coherence](http://goldenmean.info/coherence) ). Coherence is the STRENGTH of your relationship to your muscles because it is how your mind reaches and touches.

We can measure the force of attention by measuring the COHERENCE of brain waves. (Solutions to addiction and A.D.D. [goldenmean.info/tranceandance](http://goldenmean.info/tranceandance) ). Coherence is what the Shaman and the Tai Chi master learn.







***Life Force Is Measureable Because the Principle of Life Itself IS the Ability to Attract and Self Organize CHARGE!***

**Above: Tree clearly effected by the presence of a loving person.**

**We were amplifying the charge or capacitive field, picked up at the base of the tree, and spectrum analyzing it, looking for COHERENCE.**

**GEOPATHIC ZONES PICKED UP - FOREST HEALTH AFFECTED BY HUMAN METALLIC IGNORANCE...?**

**On this bottom plot above, it appeared that a strong 70 hz or so resonance of a large very metallic fence was strongly and negatively affecting the life force of the tree being measured. This appeared to be confirmed, when we checked the spectrum of emissions of the fence itself, and noted to apparent begin to rot of the trees the fence line pointed to.**

**Note that the harmonic content of this foreign non-living frequency limits the spectral bandwidth AND THEREFOR THE LIFE OF THIS TREE..?**

**The skill to align waves is called FOCUS, whether you are in optics class, or martial arts class - And now that we can MEASURE coherence in the EKG with new elegance ( [goldenmean.info/hearttuner](http://goldenmean.info/hearttuner) ), indeed there is no excuse not to teach our kids how to steer tornados.**

**Power Line Grounding & What's Poisoning the Farm?**

**Understanding How Earth's Subtle Magnetism Makes Things Grow,**

**and What Utility Line Grounding thru Earth instead of Wires back to Generator do to Kill Life Force.**

The feminine nature of the dairy cow makes it a veritable 'canary in the cave' predictor of when the Earth grid magnetics become poisoned. This is sometimes referred to as the "Stray Ground" problem. I am remembering the evening back in Buffalo NY, when the mother of the dairy farmers family wept at an Electrical Inspectors meeting. Her entire family presented their story (the loss of the majority of their farm dairy cows due to the stray ground currents) at length to the engineer's from the area cable television company, electric power company, and the Electrical Inspectors regional meeting.

As the guest speaker for the evening, my position was to emphasize that Power Grid imbalances create very large amperage flow down ground wires into the Earth. This creates diseased nests in the geometry of the underground magnetic flow lines in the region. Plants use order or coherence in the magnetic or dowsing or ley lines to create ordered water which makes cells grow. Birds get lost when magnetic lines get scrambled. Animals are particularly sensitive to these geopathic zones.

Our Earth regards magnetic flow as an information blood stream. Our power grid is in the habit of using the Earth herself as a huge dump path for hi amperage information pollution in the form of transformer grounding. The cable company's ground lead is a 'sick' path for carrying the power grids transformer ground waste'noise'(a poison) into the Earth. This causes the Earth herself to bleed. Nature never intended the Earth herself to be a return path for billions of 'dizzy & misqualified' electrons needing a way back to the generation plant. Normally - tiny currents in the Earth are the blood of bliss into the cows. When we poison that flow - we poison the cows.

The result here was the complete loss of a dairy herd, but those cows were really just being helpful enough to report a problem which is killing people, plants and animals alike. In Europe there is no 110 volt imbalanced transformer center tap. Here in America it is an obscene travesty to the Earth grid, and as Spark Burmaster and other pro's in Wisconsin teach, at the least a complete isolated 4th wire is required to take junk electrons back to the plant, and not to Earth's plants. If we really understood what we were doing to the delicate flower of magnetic lines which make things like underground water flow, we would pass EMERGENCY LEGISLATION making high amperages down ground wires as illegal as dumping mercury in the city water reservoir. They are equally destructive to health.

If users were to measure the AMPERAGE of the wasted energy they were paying for going down into their ground rods, they might realize the extent of the electrical garbage which is poisoning the Earth grid. Not only are they paying for this wasted energy, but the "stray" voltage pressures in the soil measurably: -kill all the Earth Worms, -cause dramatic health problems to plants, animals and people.. Gary Skillen reports consistent dramatic soil compaction/ soil death immediately around high voltage public utility metal power line towers. This is a global problem deserving global attention.

**It is much harder to properly balance and tune a power distribution grid, so as to dramatically reduce the hi amp ground imbalances at transformers which so poison the Earth. As the catastrophic health impact of these ground problems become understood, we will need laws to severely limit the amperage a power grid can pour as pollution into the Earth's fragile magnetic bloodstream.**

If we take the time to learn some of these key concepts about how the Earth grid is delicately tuned like a flowering rose to support biology, we might serve an Earth Mother in some severe pain.---

**From:** Marty Cain (as mentioned above - dowser, labyrinth desig, artist: , [www.martycain.com](http://www.martycain.com) )

- +Focused attention with love directed toward a person will increase their aura as well as the aura of the person focusing and sending the love. I teach that focused attention with love is the most powerful tool we have as human beings.
  - +You can communicate with all life, wisdom, intelligence's when you do through your heart. Talk to trees and
  - +Water is alive and will move with a mere request from the heart... that is if it does not have a prior agreement to share its life force somewhere else.
  - + All is made of the same stuff, only organized differently, so all is alive, all is conscious, and intelligent, and reachable through love.
    - + How quick the black helicopters show up over your newly laid out and blessed labyrinth!!!!
  - +Water is a carrier. If non Phi waves enter water it carries it and emits the frequency along the way which causes cancer etc. The water is NOT the cause. If a geomancer can work with the detrimental energies before they enter the water the problem is solved. (my sense of what is going on)
    - + Microwave towers seem to be turning beneficial energy lines into detrimental ones. Also the satellite transmissions are causing great harm. People are becoming so sensitive they can not go out of their houses. Is this also so in Europe??? (good question)
- Love, Marty Cain

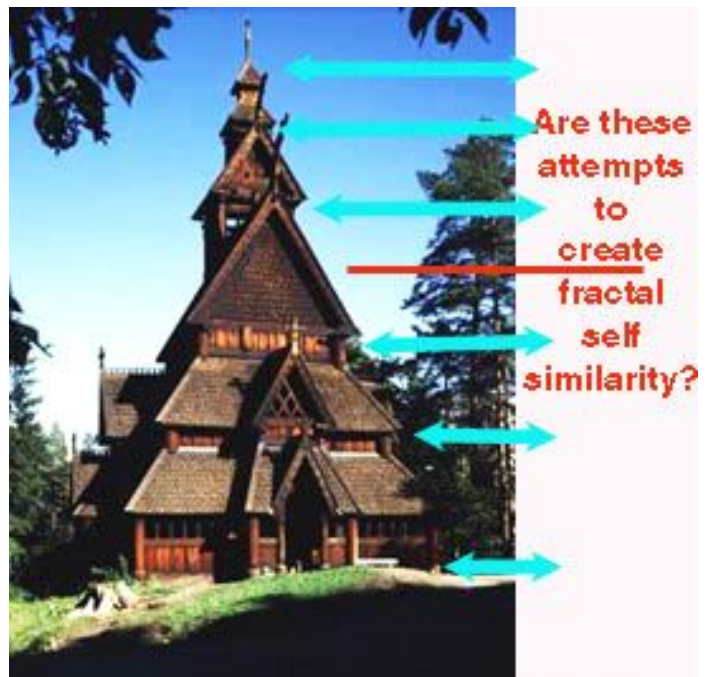
**So, what's the simple summary: how do you get your place ready for bliss?**





**Vesting Bourtange, Royal Estate in Holland:** Atlantis was laid out with concentric rings of water and land - just like Amsterdam is today. This ring like layering of more conductive (water) with more insulating 'dielectric' (land) - is PRECISELY the principle of a cylindrical CAPACITOR. ( a 'condensor' ). The very WORD Atlantis from ATLATAL - means PROJECTILE. Hermes (Thoth / Enki's son who line became Akhanaton/ Moses - PTAH) designed the architecture of ATLANTIS (Thule) to be a PROJECTOR for SOUL GROUPS whose BLISS could EMBED them or PROJECT them into STARS! ( more: [goldenmean.info/amenti](http://goldenmean.info/amenti) )

**Here - sacred space in the FAMOUS WOODEN CAPACITOR LIKE STAVE CHURCHES OF NORWAY AND SCANDINAVIA. Notice the LAYERING LIKE AN ONION. (Think also of the ONION LIKE - charge holding of the STEEPLES OF EASTERN CHURCHES)**



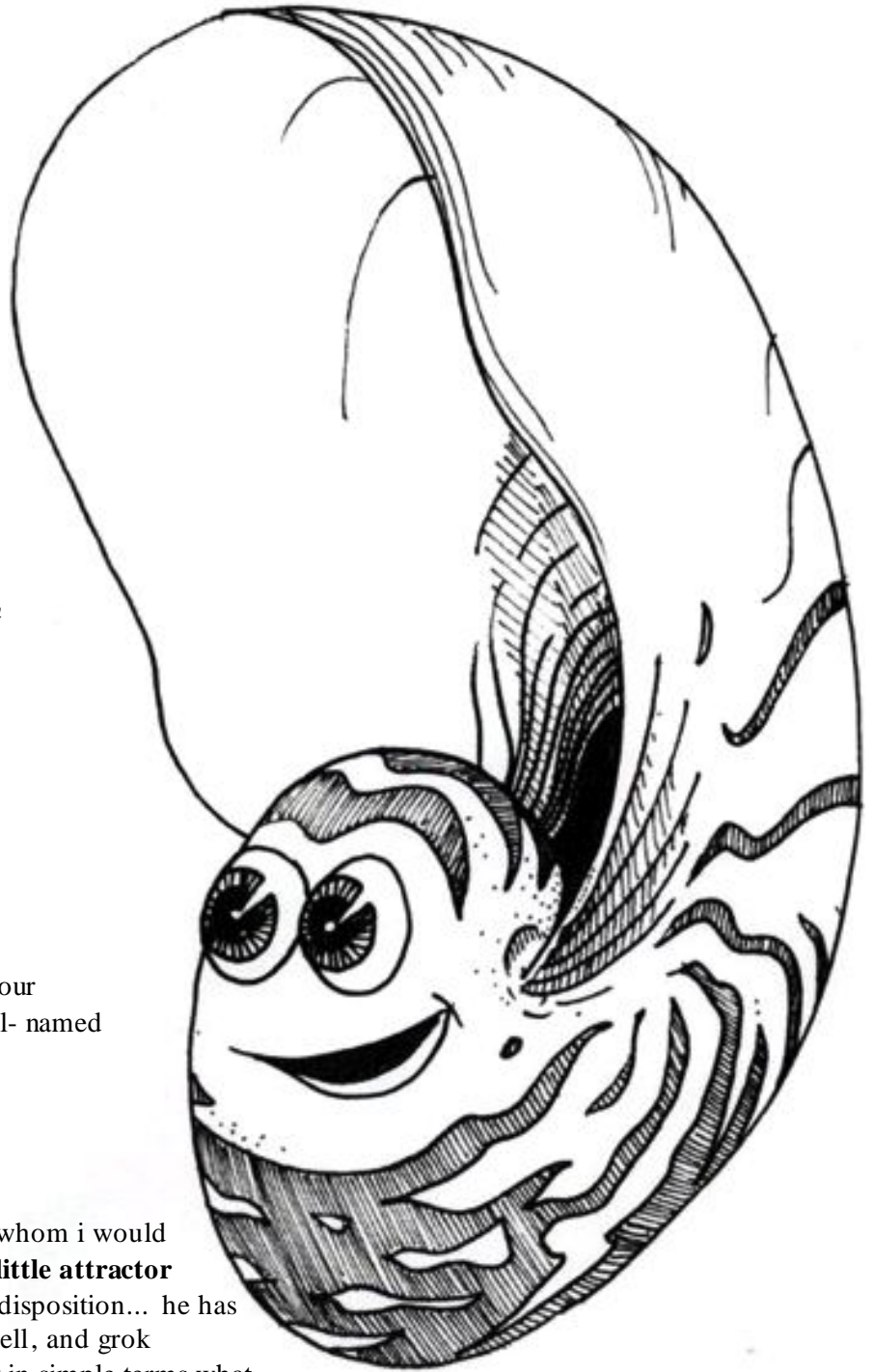
**Hygiene for Bliss: How to create  
ECSTASY, IMPLOSION and IM-  
MORTALITY  
in your ENVIRONMENT -**

**Starting with  
the ARCHITECTURE  
OF SACRED SPACE**

**This section features:**

*Michael Rice - - Wholistic Architect  
from Portlaoise, Heart Chakra of  
Ireland teaches our course in America  
& elsewhere in collaboration with Dan  
Winter*

*- be sure to visit his new web site  
[holisticarchitecture.com](http://holisticarchitecture.com)*



Michael - also brings us the drawings of our favorite sacred geometry - guardian angel- named NAUTILUS!!

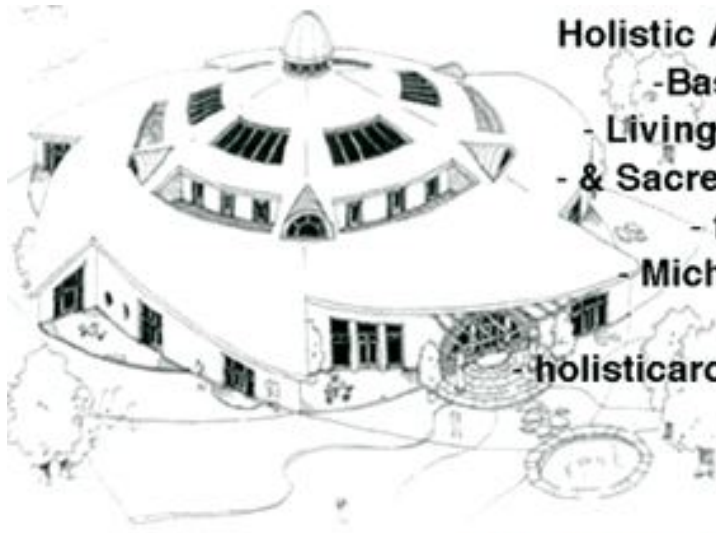
Let's allow Miketo introduce him:  
" Hi dan and valerie..

I have attached drawings of "Nautilus"..whom i would like to introduce to you!. He is **a grand little attractor** shell, with a quick mind and humourous disposition... he has a remarkable ability to focus and listen well, and grok what is been presented and to speak back in simple terms what he has understood...

He is more than willing to make himself available to help and be of service to anyone who is seeking pure principle...and can bring great clarity to any situation...he is a great sorter!

He would like the opportunity to help out in your book if that were appropriate and thinks perhaps he might be permitted to say a few summing up words at the end of each section... just for clarity you understand... he finds that if he can absorb it and speak it back then he has got it!.. but he is very much of the Winnie the Pooh school of philosophy whose basic premise is "**SIMPLIST IS BESTEST!**"



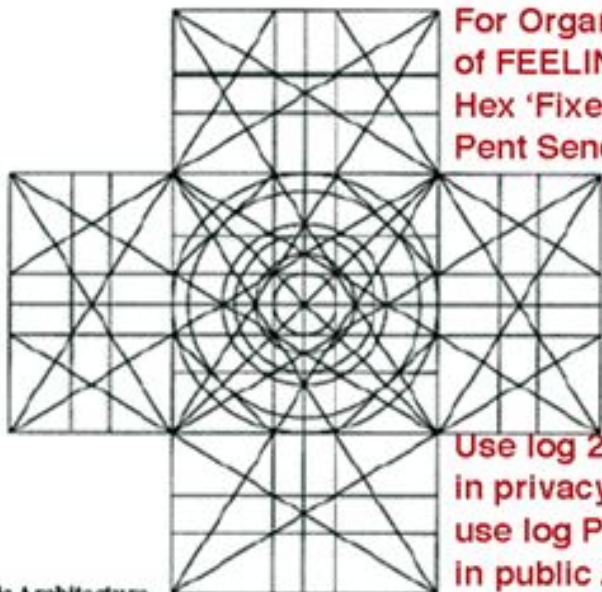


**Holistic Architecture**  
 - Based on  
 - Living Curvation  
 - & Sacred Geometry  
 - from  
 - Michael Rice

[holisticarchitecture.com](http://holisticarchitecture.com)



*The Michael Rice  
 Holistic Architecture  
 Gallery*



For Organic Architecture  
 of FEELING Spaces-  
 Hex 'Fixes' (holds inside),  
 Pent Sends!

Use log 2 edge ratios  
 in privacy spaces -  
 use log Phi edge ratios  
 in public /projective spaces.







Here: Michael Rice shows us his fabulous Sacred Arch Egg Cocoon design: No metal, good grained wood, charge focusing curvature. The true : ARCH-I-TECT.

In this Bliss space: no one wants to leave - because it FEELS so good. It is EGGS-actly what we are talking about. It is almost as nice as the egg you were born in. A VERY good charge squeezing capacitor.

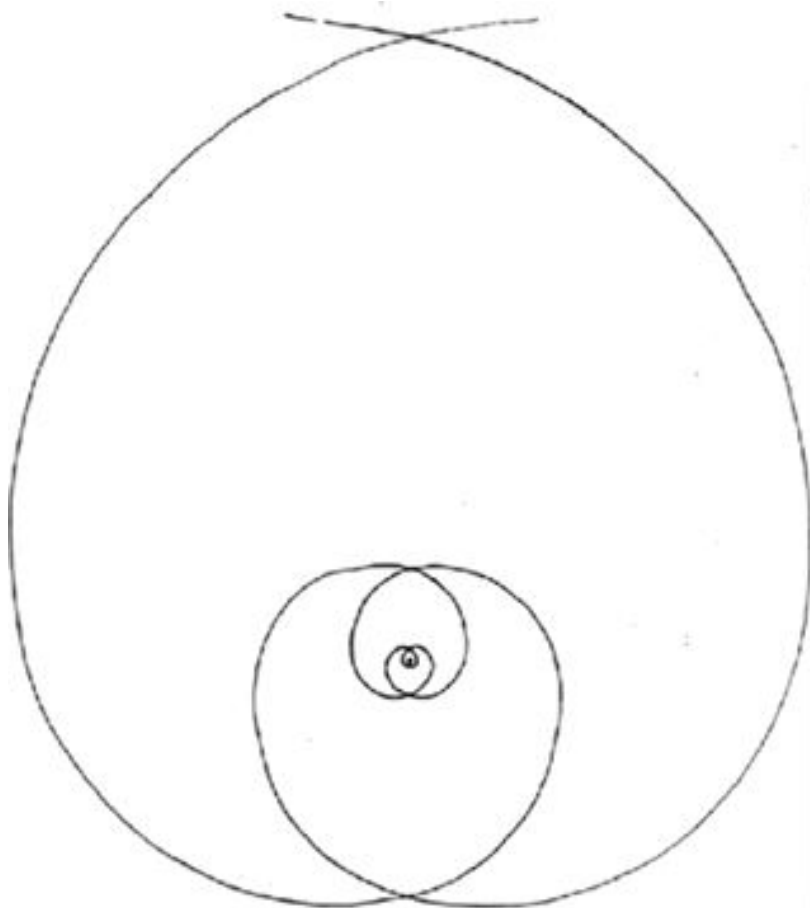
Imaging if home and refrigerator builders knew how to craft LIFE FORCE into built space!!

**We are preparing the ideas to more practically APPLY this new simple science of what BLISS is - to making it happen for you. As we suggested - we will be dividing the HYGIENE FOR BLISS- into 4 easy sections:**

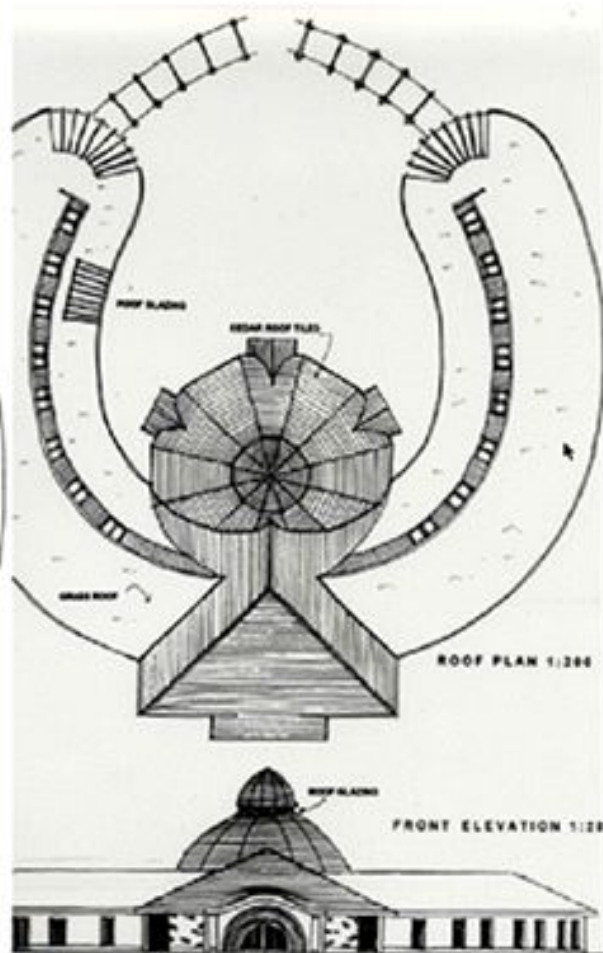
- 1. Diet**
- 2. Place**
- 3. Dance**
- 4. Ritual, Initiation & Group Bliss**

**This is the section on making your PLACE - your SPACE into a BLISS ENGINE.. Look around - is there natural fabrics, wood, stone, fresh air, & silence - electrically and silence in sound around you? If you are surrounded with electrical magnetic pollution (transformers) - lots of METAL, noise & bad air. Then we suggest you read this section carefully - to learn to gently re-carve your space in SACRED CHARGE!**

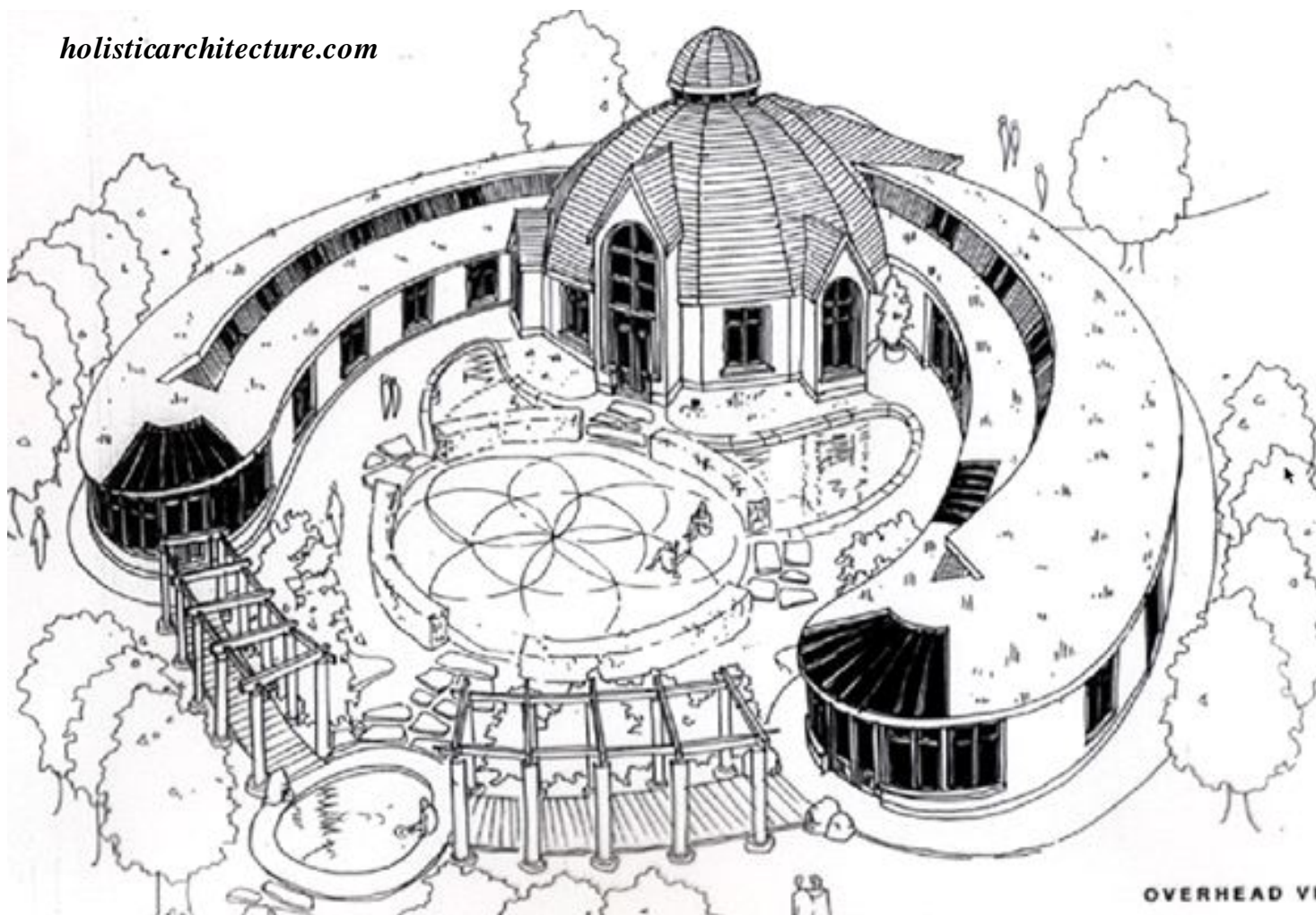




THE WAVEFORM OF UNCONDITIONAL LOVE AS A COHERANT SELF EMBEDDED FORM MATRIX FOR THE BUILDING SHAPE



[holisticarchitecture.com](http://holisticarchitecture.com)



OVERHEAD VI

Note: Sacred Architecture and the SCIENTIFIC aspect of FengShui- are included here as part of the curriculum for the Practitioner's Certificate Course , Sacred Geometry with Dan Winter- refer for [goldenmean.info/course](http://goldenmean.info/course) , and Roger Green Internation Feng Shui Curriculum - [fengshuiseminars.com](http://fengshuiseminars.com)

The only definition of sacred (means sustainable) architecture is the skill to fabricate a biological capacitor.

The way success is measured (in a building or in an apple.. even [in a big apple like NY](#)) is harmonic inclusiveness of charge density (life):

### **Architecture as Sacred Space:**

If Life Force Equals the Ability to Attract and Self-Organize Capacitive Charge - It Now Becomes Possible to Outline the Function of Architecture.

One reason architecture should look like biology is that biological structures have discovered thru evolution the materials and shapes which allow the electrical fields we call LIFE to converge into self-organization and self-awareness. The ability to self-organize and "FUSE" charge into living form is the appropriate goal for architecture because it is the only way to achieve the electrical sustainability as wave which is a scientific definition of immortality. In other words- **focus & compress/ implode charge in architecture & you get LIFE!**

For example, biology never uses a sharp corner because it would bleed electrical force. You have never seen a Van De Graaff Generator with a corner, it is very rounded. Biology never uses sharp edges except exactly where charge NEEDS to be projected.

Architecture for healing - we can measure a person & their building for charge inclusiveness - to adjust the architecture to intensify the healing process. Embedding . Paramagnetic stone allows building to respond to the quality of the human being - by embedding the person in the self-similarity - the compressibility and holy communion of biological capacitive charge - formerly called orgone, barrakah, chi, shaktipat, blessing. Biologic structures alive with breathing compressing & fractal magnetism are symbiotic - self-aware and alive.

Healing temple - would not look like a temple as we know it. But is a biological structure. The straw bale temple - & the hemp block, and even the sun baked clay / straw brick were FABULOUS LIVING CAPACITORS.

"The bee hive and the pine cone are excellent examples of sacred architecture because as biological capacitors they implode charge making life and bliss possible and sustainable. They are made of biologic dielectric (self-similar at atomic and molecular symmetry levels)- what Reich used to call organic orgone material- really names for fractal capacitive dielectric. Dielectric is a name of the quality of the insulator spark cap where capacitors catch the memory of stars.

***The metal building ...or the western idea of what is a refrigerator - with sharp edges and bad air in urban areas are examples of structures which make only death and prevent bliss because they are bleeding capacitors and therefore the opposite of sacred architecture.***

Chi is a name for a capacitance, When you arrange a capacitor.. in a fractal you get gravity... , Sacred Geometry is a map of the geometry of pressure called the unified field. When the Mind pulls in light and sound simultaneously, a short wave is embedded in a long wave and the sacred geometry of a fractal attractor is born. Memory makes gravity.. the wind to center of implosion. Self-similarity perfected by Golden Mean ratio (think of pine cone type symmetry) - turns (charge) compression in to acceleration - the only SOURCE of gravity - the only self centering force.

Only love (lo-phi) bends the light - therefore only love creates.



## In 'CHARGE' of Life: Architecture of The Sacred & The Sustainable.

In this part of our study of Sacred Geometry, let us imagine we are the architect of the universe, and we wish to play "Sim-Universe" This is the next software game which should follow "Sim-City" and "Sim-Earth". When Lovelock, author of "The Gaia Hypothesis" wrote the software code in "Sim-Earth" which regulated how planted paramagnetic dolmen (sacred stones like Stonehenge and Avebury) affected evolution of genepools, he correctly projected that the burn rate of evolution would increase at the risk of available resource. - He did not understand WHY the addition of simple magnetic symmetry would increase the metabolic burn rate when fed to a compost pile - again by simply arranging stones like lenses to steer the magnetism into the 'pretty picture' we call symmetry. Our goal in this section is to understand this. What is the simple scientific pure principle which explains why **adding SHAPE in simple symmetry to magnetism and electrical charge creates a direct means of FEEDING LIFE FORCE to biology and evolution ?**

Remember **the evolution of consciousness IS the ability of a field effect (in this case the 'charge' radiance of genes and glands) to propagate and distribute itself.**

We have learned a little bit about how electric waves in the universal compressible medium can be arranged into patterns which create LIFE itself. We wish to now apply those principles in a practical way, to design and build LIFE.. into our homes, offices, landscapes, and even - into our refrigerators.

If you understand what follows, you will begin to comprehend that there is no possibility to become a sacred architect of ANY sort, unless you can design a capacitor. The reason a beehive or a celtic straw hut in sea spray makes things live so long, is because they are good capacitors. Ancient dolmen sites and even cathedrals hold you in bliss in the spell of their charge, because they are 'in charge' - that is - FULL OF CHARGE. Life occurs when biological structures learn to gather charge in enough different wave lengths to cause them to compress or 'implode'. You are going to read about 'implosion' here as you learn that this is another name for a 'fractal-attractor'. When enough different waves gather to one place in the Golden Mean ratio.. they begin to suck in an infinite number of other waves - but always in Golden Mean ratio. This is the only way the universe has of arranging for an infinite (in-PHI-knit) number of waves to gather at ONE point without hurting each other. This principle of IMPLODING - waves you will see - is going to become the symmetry (or pattern) ESSENCE of:

1. Making Gravity out of waves (how charge or power can be extracted from gravity as well)
2. Making LIFE - and making waves appear to become self-aware and self-steering. ( pics at [goldenmean.info/phiricais](http://goldenmean.info/phiricais) )
3. Creating the electrical requirement to make ATTENTION possible, as well as 'enlightenment'.

To understand all this well, we need to sort out the connection between IMPLOSION, and getting fractal like a rose .. and making LIFE.

Once we understand that the skill to persuade waves to agree IS - LIFE and SELF-AWARENESS. We can begin to practically USE the symmetry and musical harmonic 'RECIPES for PHI IMPLOSION' - to perfect the sacred architecture of our living structures.

First let us 'agree' that SUSTAINABILITY for wave pattern, is the only definition 'SACRED' ever had. The symmetry or pattern ingredients to get waves to implode - cause them to stabilize (that is RESIST change of position). This resistance to being pushed around which a wave going like a gyroscope in a circle creates, is called INERTIA. Inertia is the only definition or measurement physics ever had for MASS. So .. teach a wave to sustain a circle (a gyroscope) and YOU are the CREATOR (God) of matter out of light. The trick is, keeping the implosion going in the middle (called Gravity), so the waves does not fly out of the circle. (From mass to energy). The path of perfect "TRANSLATION of that VORTICITY" from the circle to the line - which is FROM MASS TO ENERGY - IS- The Golden Mean Spiral. (Yellow Brick Road - kind of thing.)

Second - let us notice that our new definition of LIFE : “The ability to attract and self-organize (store) CHARGE” is measurable. ( see [goldenmean.info/biophoton](http://goldenmean.info/biophoton) ). To measure life as an electrician we do an harmonic analysis of the capacitive charge field around say an egg, and the more HARMONICALLY INCLUSIVE - which is to say FRACTAL those waves of charge are... the more ALIVE it is!

What happens when a biological capacitor like a pine cone or a fresh egg or the electrical shape of your heart wiring which cause it to ‘phire’, starts getting VOLTAGE FROM GRAVITY? ... We call that - the moment it becomes ALIVE. (2 to 10 millivolts generated from gravity by the average fresh chicken egg - ask your physics professor where that comes from.)

The perfect COMPRESSION called IMPLOSION is key to that energy source... and the source of ALL life. So we MUST know and teach that symmetry recipe to make implosion, or we will lose ALL life!

What is cool, is that this little symmetry picture to arrange biological capacitors to CREATE LIFE - like - your furniture or your emotions, or the stones around your house and garden ... is as simple as looking at a rose! So it is easy to teach.

Suppose you are like our friend C.K. in Germany. Generations of PHYTOCHEMISTS (studying life and healing using plants) - noticed that they could predict if a bioregion could produce healing plants - by checking ONE ROSE GROWN THERE. If the inside of the rose flower pattern - looked exactly like the outside of the rose flower pattern in that same rose - then the plant healing expert would know that the bioregion contained the symmetry ability to compress charge - and that predicted healing! This principle of the inside looking like the outside - is called FRACTALITY. Roses, pine cones, fern trees etc. are biological examples - they show us how NATURE compresses charge to make life.

Physics has no quarrel with the essential insight of Einstein and all religions, that the universe is made of only a single substance: a unified field. What has been a bit troublesome has been to map the symmetry or wave pattern relationship between some of the attractions observable in that unified field.

The problem of getting to a complete idea of that ‘unified field’ was delayed by the fact that physics initially failed to observe a fundamental symmetry connection between such attractions as electrical versus gravity. This was simply because the principle of compression that produced acceleration eluded them. The solution to MAKING that charge compressor that DID accelerate - is and was FRACTALITY ... ‘self-similar’ like a rose.

This principle occurs because waves (of ‘charge’) which cross upon themselves in a rose like FRACTAL pattern, add AND multiply their wave **velocities** - (as well as their wave lengths) RECURSIVELY (that is like compounding your interest at a bank) ..AND always CONSTRUCTIVELY. Reference: [Heterofi, Heterodyning and Powers of Phi \( goldenmean.info/heterofi/heterofi.htm \)](http://goldenmean.info/heterofi/heterofi.htm) To think about how a wave might cross another and add and multiply the wave VELOCITIES - think of a surfer. He enters to tube tunnel in a cresting wave, then the curl of white cap collapses wave comes rolling in from the side. The wave from the side at one moment COLLAPSES on the wave coming straight on - AT THAT MOMENT THE SURFER IS SHOT OUT FROM THE TUBE LIKE A GUN! That is a wave which took its VELOCITY and ADDED it to another wave. IF those waves were meeting in the Golden Ratio pattern like a rose fractal ( see pic below - pents into the tube tornado) - THEN the adding of wave velocities becomes CONSTRUCTIVE RECURSIVELY (repeatedly). This is how CAPACITORS ARRANGED IN A CONE (like the seeds in a pine cone) MAKE GRAVITY and MAKE VOLTAGE FROM GRAVITY. Because again - gravity IS acceleration - the ACCELERATION of that CHARGE resulted from ‘recursive’ (repeated) self-similar ‘fractality’.

**This turns compression into acceleration.**

***You gotta make gravity to make life. You gotta make life to make gravity. Other wise you will be ‘blown away’ / ‘pushed around’.***

The proof was that capacitors storing charge waves crossing when arranged in a rose or fern like fractal or cone ...(like seeds in a pine cone)..PRODUCE gravity. Capacitors in a curve or cone approaching this geometry of ‘self-similarity’ CREATE THRUST. (Replacing things like rockets and car motors.) ( pics at [goldenmean.info/phiricaais](http://goldenmean.info/phiricaais) ).



Physics already understood that acceleration WAS gravity. (Arguing whether acceleration produces gravity or gravity produces acceleration is very chicken and egg ).

So the PATTERN or 'symmetry' recipe to make charge electrically go into this compression acceleration tornado becomes the holy grail for the physics of the unified field. See the grail animation at: [goldenmean.info/grail.html](http://goldenmean.info/grail.html) - that animation is the only 3 dimensional fractal - AND the way to arrange capacitors to make gravity - which is why it is a symmetry map to the dodecahedron - 'wratchet' fractal gravity maker which is DNA!

This is how we recently solved Einstein's dilemma about finding the shape (symmetry) which allows waves to infinitely compress. (Instead of "The Perfect Storm" - we get "The Perfect Tornado").

The answer was really simple, you take the Golden Ratio branching called Phylotaxis which is the definition of all plant life unpacking, and arrange capacitors in the same way, and you solve the problem of PACKING. Electrical waves which we may at first simply label as charge. (Later we will learn about the difference between charge as a simple difference in electrical potential pressure difference which is called VOLTAGE - versus when that same charge is STORED and measured in FARADS as CAPACITANCE ).

A certain symmetry or pattern among waves ALLOWS or INVITES charge to be stored. This capability to STORE CHARGE by learning the kind of 'slip knot' symmetry - gets us close to understanding how matter is created out of energy - or simply out of waves.

**When we invite charge into compression space - we make gravity and life. Think about why a bee hive might be the ultimate definer of what is sacred architecture: It is such a great pine cone like fractal attractor for capacitive charge. Let us 'take a lesson'. Eventually we are going to need to learn about the definition of the construction materials called 'biological dielectric' (the quality of the insulator in between the plates 'spark gap' of a capacitor - is called the DIALECTRIC ).. which nature uses to build life. Then we can design a building ! ... & a refrigerator ... (hint nature almost never uses metal to contain life - because it is not fractal.)**

**Intro to LIFE FORCE thinking (for non-electicians who WANT to make life)- using ELECTRICAL CHARGE as the principle.**

First step: if we are going to explain to you how life propagates itself - as charge - and then ask you to change the menu and architecture at McDonald's based on the goal to serve life electrically - THEN - you will want to understand what CHARGE is!

So- what is the NATURE of charge itself?

When you rub a pen on some wool and create a spark - what do you do? You create an electrical difference of potential which initially can be measured in VOLTS. Science explains the difference between positive and negative electrical potential - as the presence of free protons versus electrons. You will begin to see in the conversation which follows, that this is rather limited thinking. The real issue is to begin to see the relationship between tornados that SUCK versus PUSH (centripetal versus centrifugal). If you REALLY get the proposed reason here that LIFE FORCE requires the ability to become ELECTRO-NEGATIVE in order to ATTRACT THE CHARGE -which IS life itself- to you. For exactly this reason - **the baby that does not learn to suck - may die!**

In Ted Barody's book "Alkalise or Die" - the REASON blood must become electrically attractive to protons (extra 'electrons' or 'electron space' is associated with alkalinity) - is because - if the blood cannot ATTRACT electrical charge - you begin to decay and get sick.

Think - what SUCKS the egg into the wall of the womb. IF that suction is successful - the egg EMBEDS and then gets nourished. If not- it dies. That suction to produce life critical embedding - is primally electrical in nature / in principle.

Protons, for example, and ‘free radical’ hydrogen ion (atom) are thought of as being electrically positive. Electrons are negative. The real meaning of this, requires visualizing (picture below) - the DIFFERENCE between centripetal - or inward sucking spin - versus - centrifugal - or outward pushing spin. See in the below pic- understanding this ‘hydrodynamic’ or flow-form of tornado’s vorticity having a net inward or outward - flux - IS THE KEY TO REALLY UNDERSTANDING THE CONCEPT OF PLUS VERSUS MINUS CHARGE. (and Yin versus Yang etc.).

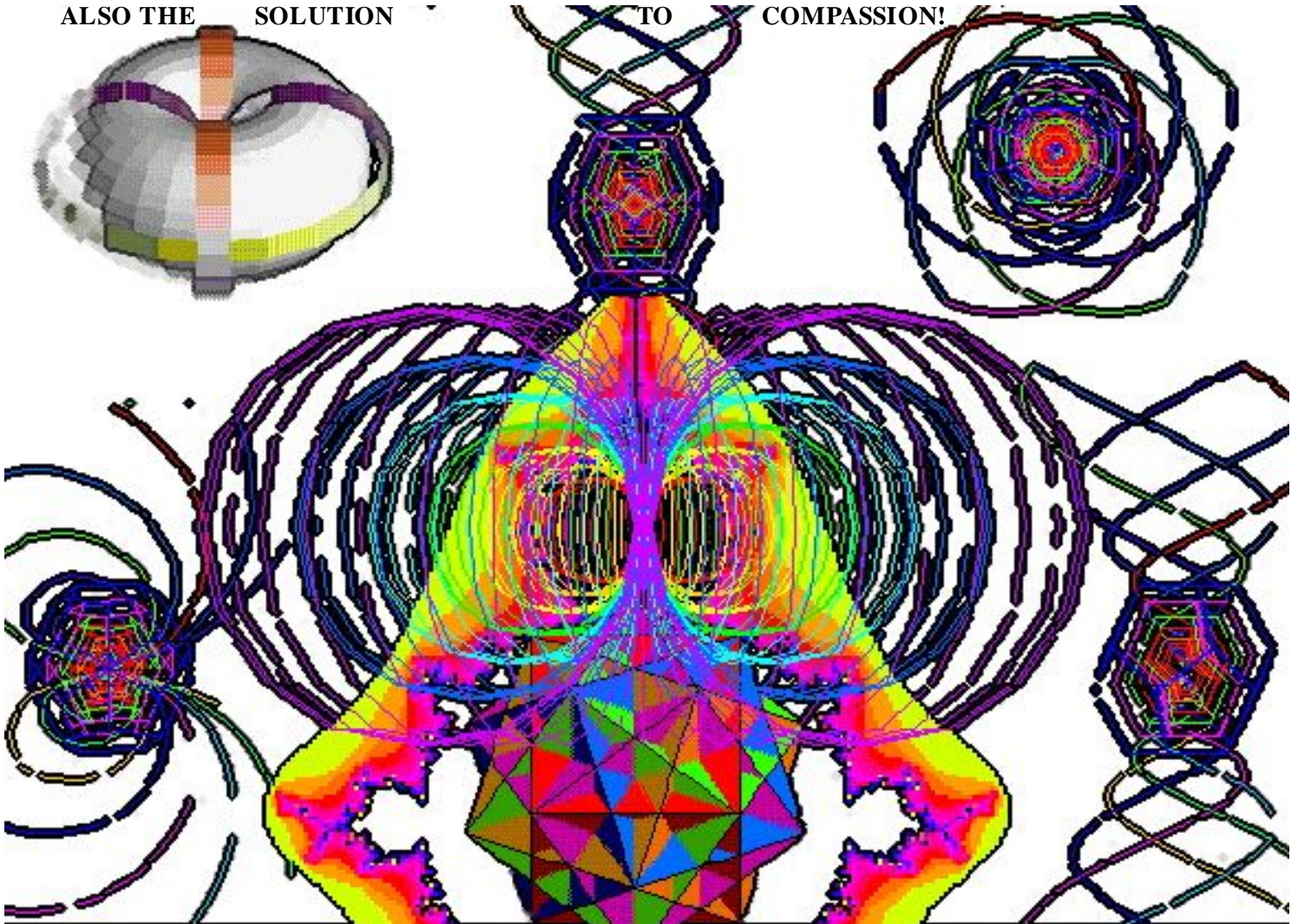
Test yourself in the next page - picture - by seeing if you can answer the question - why does negative DC magnet flux reduce pain AND healing speed ... hint: mechanically externally generated - diverging flux lines decrease focus AND sorting..)

**Becoming ELECTRO NEGATIVE - that is MAKING SPACE TO ATTRACT AND EMBED A CHARGED PROTON - becomes a definition of becoming ALIVE!**

Once you begin to see that becoming electrically attractive to charge, is how you and everything become alive (even how you attract the right people to hug you) - try to begin to see WHY fractal or rose or fern or onion like ‘self-similarity’ electrically - is how anything alive - BECOMES THAT ATTRACTOR (below)... It is because when the inside of a wave nest (like your heart) becomes self-similar to what is outside- THEN - the outside can fall in!

We measure this ‘turning inside out ness’ based on PHI the Golden Ratio enabled or compression — by harmonic analysis in the EKG (heart). This becomes the musical symmetry and definition of compassion - in principle. To feel for what is outside you - you create an image of that inside you. Only that fractal kind of data (wave) compression is infinite. That invites the outside - IN - to you. THAT IS COMPASSION. And it IS compression. You make space for someones feelings which were outside you, inside you.

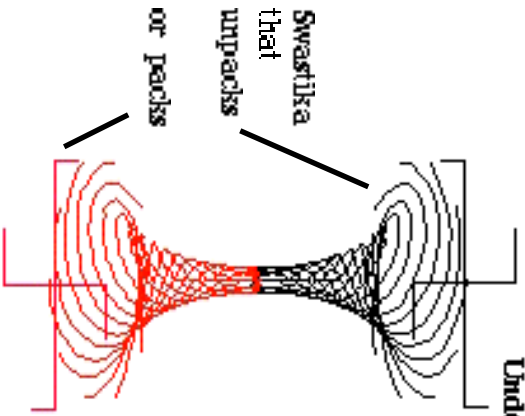
Infinite non-destructive compression - now solved in the symmetry lesson of PHI based ‘fractality’ was not only the solution to Einstein’s dilemma of how to get voltage from gravity in a unified field - IT IS ALSO THE SOLUTION TO COMPASSION!



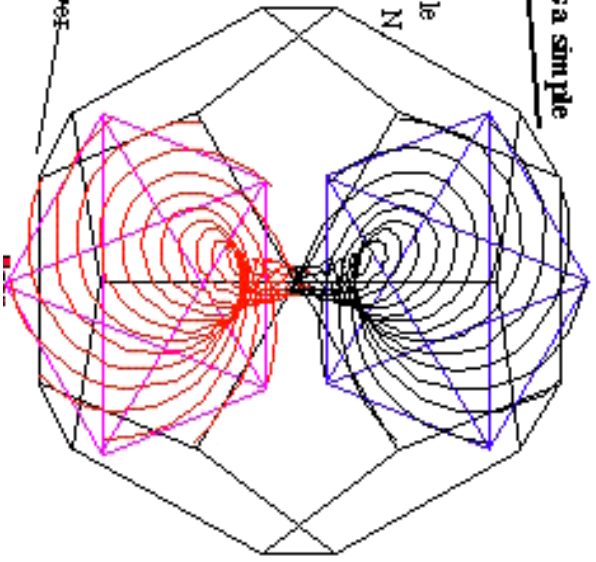
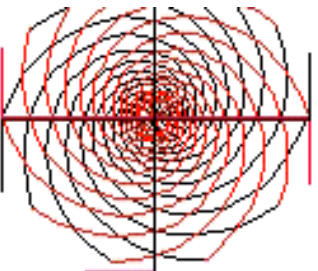


**Magnetic Polarity: Essence of Flow Direction.. Converging/Diverging Flux Lines**

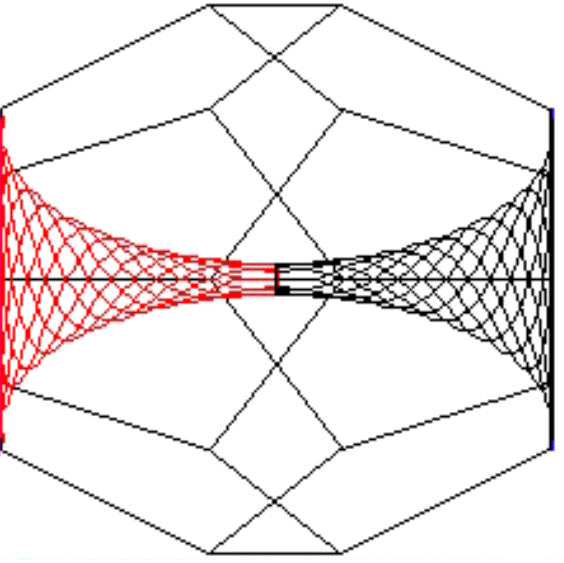
**Understanding the Biological effects of Magnetism as a simple  
twister flowing either inward or outward**



- Bio-Magnetic North
- Attached to South Pole
- Conventional Magnetic S.
- Outward Folding Flux
- Yin
- Centrifugal
- Unpacking
- Negative
- Counterclockwise
- Blue Making Power
- Wet Making Power
- Touch Making Power
- Pentacle Upright
- Cooling
- Swastika Left
- Leve/Word Making Power
- Unpacks the Hard
- foldedness of Cancer
- (Cancer IS
- Contact Inhibition
- The failure to respond to touch)
- Reduces:
- Pain,
- Infection
- Swelling
- He m m o r a l i n g .
- Moves H + ions out of infected area.



- Bio-Magnetic South
- Attached to North Pole
- Conventional Magnetic N
- Inward Folding Flux
- Yang
- Centripetal
- Packing
- Positive
- Clockwise
- Red Making Power
- Hard Making Power
- Separate Making Power
- Pentacle Inverted
- Warning
- Swastika Right
- Adamic/Atomic Making
- Peaks the Wet Unfolded
- of Aids
- Stimulates Thyroids.



Gently start to work, 1 step at a time, toward living in a space which has the following quality:

1. The area for living was chosen - by making a magnetic map- and seeing where the charge - the flow of magnetism - was converging nicely. It is the same as preparing to locate the CENTER of a potential labyrinth. Where the charge converges is where seeds germinate, where the compost pile does well, and where people thrive and have FEELINGS which literally INHABIT the land. In FENG SHUI - the science meets the tradition. The SHAPE of the land and water which makes sacred space - LOOKS like the sexual part of the body of a woman! The reason is clear - this is where charge is squeezed- NON-destructively!!

2. All structures around have been arranged to eliminate metal. This means the aluminum and tin and steel building materials have been carefully replaced one by one. (In America plastic concrete reinforcement bar meets building code.) Concrete is a nice capacitor but the metal they place in it is what makes your feet tired because the charge bleeds to death. Metal roofs and fences prevent rain, prevent dreaming, and prevent successful dying (and birthing). Metal has molecules which have departed from fractal embedding due to un-natural (not solar embedded) HEAT. When molecules get scrambled out of fractal recursion (fractionation) - then they cannot BREATHE the charge of life recursively compressing in to center. This is what it really means to NOT be ORGANIC. (To fall OUT of fractal embedding).

Metals are listed here - whose CHARGE RADIANCE is graded from the LEFT:

Poisonous to all of life -      to better      -- to induce charge to SERVE life (self-similarity)  
 Aluminum, Tin, Steel, Titanium, Copper, Silver, Palladium, Gold.

So- for proper building material to MAKE a biologic capacitor - capable of holding the CHARGE we call BLISS - ECSTASY and ENLIGHTENMENT - we have:

#### PREFERRED MATERIALS:

Wood (close grained is best), Stone, Natural Fabrics, and all material directly derived from biology - EXCEPT materials that have undergone great un-natural HEAT.

The other great danger to your LIFE FORCE - is the poisonous chemicals and glues and paints so common to building materials. This is why plywoods etc., & new synthetic carpets are so fatal to your health. Hulga Clark's famous book: CURE FOR ALL CANCERS - had a major germ of truth. The cancer virus is FED for the smell of petroleum derived substances. SHE IS RIGHT.

3. Your electrical plan needs to immerse you only in the Earth's magnetism and NOT in the poisonous crap they dump down the power lines. After you browse your house making careful plans to throw out most EVERYTHING METAL!!!!- (start with the metal coil springs poisoning your aura from inside your mattress) then start looking at your wiring.

The sensible homemaker - eliminates every non-essential electrically powered item from their home. The MOST absolutely nauseating poison comes from all devices which have a transformer in them - ESPECIALLY those whose transformer NEVER SHUTS OFF!!!! This includes the keep warm circuit in disgusting TV and electronics - the transformers in your computer and tv and audio rooms. Do yourself a favor - try turning the MAIN circuit breaker off in your house for 10 minutes. Then meditate.

You should get clear enough to realize you probably never want to turn it on again. `The problem was - when Tesla and Edison fought over the frequencies for power distribution (25-50-60) - neither one of them had a clue how biology depends on those reserved lo frequency bands to do her homework. 60 cycle for example is one of the frequencies at which the voltage required to KILL a heart is LOWEST. In other words - here is biologies worst poison.



**Computers: throw away the cathode tube screen jobs as fast as you can get to the dump. They are absolute soul killers. Use your liquid crystal (flat screen). Portables are good - ESPECIALLY when you can run from the battery.**

--Regarding our section on designing SACRED SPACE--

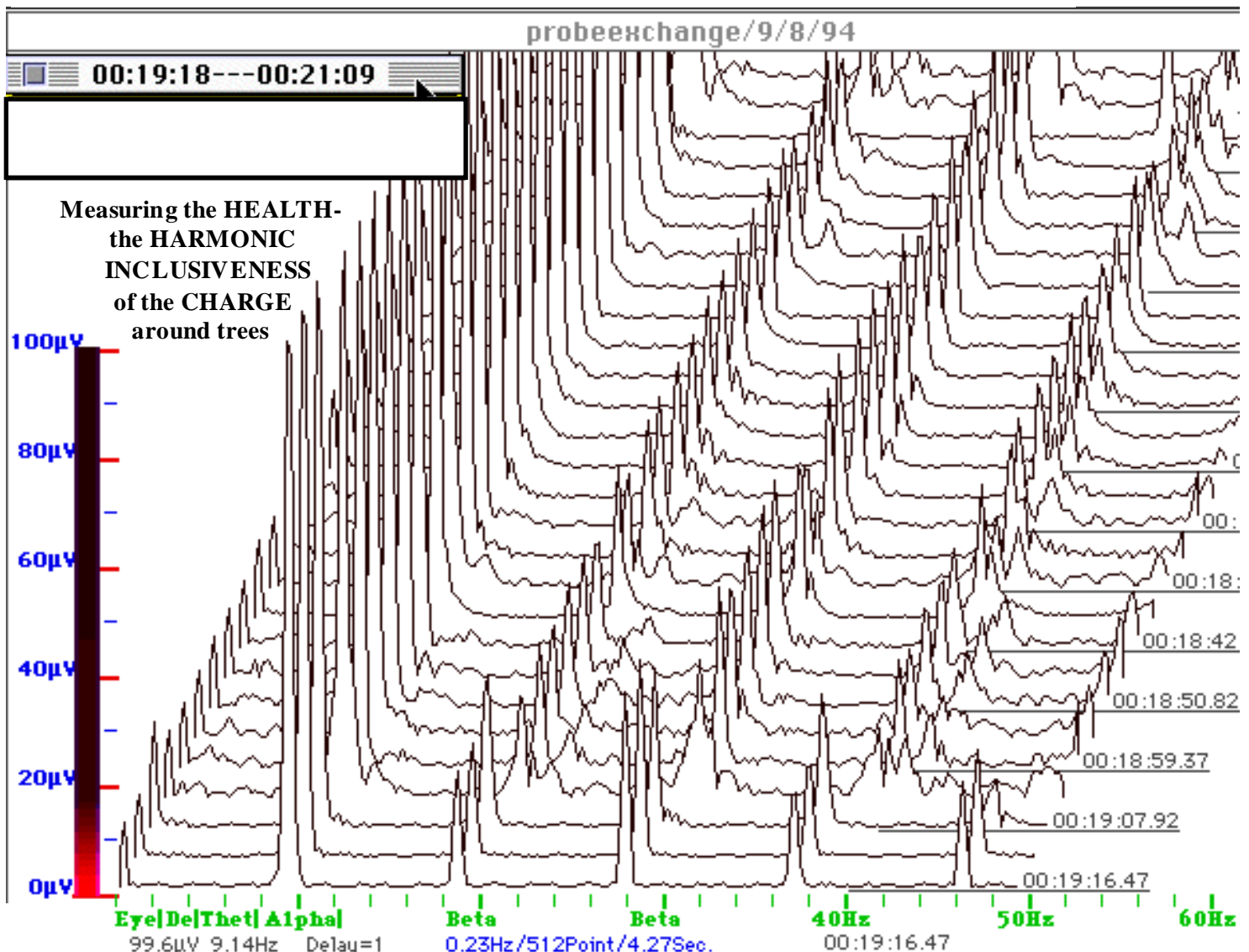
our good friend Nancy - who runs the important *psykids.net* for psychic and gift kids.. sent some questions:

“I’ve been wanting to ask you for a quote from you, specially on two things I remember you guiding us on years ago.

1. One was about having our kids live near as old growth trees as possible... the hows and whys of that in your own words would really be wonderful (and how people who live in Tulsa Oklahoma for instance can ameliorate the situation - if possible).

2. The other thing that stays with us, is a comment about not wearing man-made materials, I think you said, especially in front of the heart center because they blocked energy radiation somehow. Well that has always felt right on to me - but I’d really love the scientific languaging on that too if you have the time for doing such quotes for my book. Smiles and thanks.”

Well -Nancy - remember the scene in the book “Celestine Prophecy” where they explained that the opportunity to sit under an old growth tree - INCREASED you chances of seeing CLAIRVOYANCE. The science is simple - the older trees as fractal attractor capacitors - have nested in their aura longer waves. So the embedding their is more context rich and full of big body information. The cascade between frequencies in sacred trees measures more harmonics.. ( goldenmean.info/trees ).



So - yes Nancy - it is very important to spend time in the quiet electrical aura of large older trees. This creates a charge communion - with the oldest and most wise biological wisdom available. It is literally EMBEDDING. Trees were the first fractals known, they are the best air conditioners.

Speaking of this - air conditioning in general is a disaster to BLISS and LIFE FORCE. This is because all the CHARGE is bled from the air by the metal / aluminum fins the air is forced over for heat exchange. This is a major misunderstood clue to Legionnaires disease.

**In general - ALL FANS - are bad for bliss. Fractionation versus Fractality. You would be surprised how cooling you can be if you re=organize your space to embed and be fractal. HEAT is a symptom of the disease of not understanding compression! - example - global warming!**

Nancy's second question was about natural fabrics. All the children in Steiner school only touch wood, and stone and natural fabric. They NEVER even touch or come in contact with metal or plastic. This would be good advice for EVERYONE! Materials not born of life and fractality - are called MIS-QUALIFIED energy. They fail to embed and they will die. This is what is meant by that which is not crafted with love will melt in the rapture. That which is not compressible (shareable) will not survive the test for pure intention-COMPRESSION called rapture. The plastic and metal will not make it.

For now the metal is worse for you because it radiates life destroying charge OUT OF SYMMETRY. The plastic is not so bad if it does not off-gas.

This brings up a related question. Glass being slow running melted sand - is neither good nor bad for charge compression- so you can regard it is relatively passive in the question of whether your space is made sacred.

If you don't do anything else - at least check the strength of your arm muscle without your wrist watch (particularly fatal are the ones with a battery in them). Begin to get the idea of what bleeds your aura.

### **The Secret of PRAYER:**

**The charge radiating from your healthy body determines if you can heal yourself and others. The science of prayer and touch for healing is all about CHARGE. You are invited to review the work of famous ROBERT O.BECKER, MD: "The Body Electric". This shows that the voltage the body is able to produce DETERMINES if you are able to regenerate wounded flesh.**

**The science behind prayer is the charge you are able to generate - and then the COHERENCE you can project it with. ( related to [heartcoherence.com](http://heartcoherence.com) )**

### ***How to SEND your telepathic message:***

**You form a SHAPE in your visual field, you give it the force of your emotional COHERENCE - then you RELEASE the field effect - pointing it to its destination. Remember - even the horse whisperer was not telepathic with his horse until he stamped his foot and released a deep breath - to RELEASE the field effect just created. Focusing on the field effect picture or image is step one, (for prayer or sending a blessing) but without the necessary step two - which is the RELEASE - your prayer is not sent.**



## Does prayer effect plant seeds? (www.plim.org/PrayerDeb.htm )

161

In a study on germinating seeds done by Dr. Franklin Loehr, a Presbyterian minister and scientist, the objective was to see in a controlled experiment what effect prayer had over living and seemingly non-living matter. In one experiment they used three pans of various types of seeds. One was the control pan. One pan received positive prayer, and the other received negative prayer. Time after time, the results indicated that prayer helped speed germination and produced more vigorous plants. Prayers of negation actually halted germination in some plants and suppressed growth in others.

In another experiment two bottles of spring water were purchased. One container was used as a control, receiving no prayer; a group prayed for the second. The water was then used on pans of corn seeds layered in cotton, with one pan receiving the prayer water and the other receiving the control water. The pan receiving the prayer water sprouted a day earlier than seeds in the other pan. The prayer seeds had a higher germination and growth rate. The experiment was repeated with the same result each time.

### What effect does prayer have on microorganisms?

Dr. Dossey, in his book, *Be Careful What You Pray For*, looks closely at experiments with microorganisms. He states, "Skeptics who do not believe in the effects of distant intentions say that any observed result must be due to the expectation of the subject- or the power of belief and thought." Dossey argues that if bacteria respond to outside intentions by growing more slowly when prayed over, than control groups not receiving prayer, then one cannot dismiss this result by attributing it to negative suggestion.

Bacteria presumably do not think positively or negatively. Another major advantage of microorganisms in studies of distant mental intentions has to do with the control group. If the effects of intercessory prayer, for example, are being assessed in a group of humans who have a particular illness, it is difficult to establish a pure control group that does not receive prayer. The reason is that sick human beings generally pray for themselves; or outsiders pray for them, thus contaminating the control group, which by definition should not receive the treatment being evaluated.

In studies involving microbes, this notorious "Problem of Extraneous Prayer" is totally overcome because one can be reasonably certain that the bacteria, fungi, or yeast in a control group will not pray for themselves. And that their fellow microbes will not pray for them.

If the study involved negative intentions instead of positives, the advantages remain the same. The thoughts of microorganisms do not influence its outcome.

Jean Barry, a physician-researcher in Bordeaux, France, chooses to work with a destructive fungus, *Rhizoctonia Solani*. He asked 10 people to try to inhibit its growth merely through their intentions at a distance of 1.5 meter.

The experiment involved control Petri dishes with fungi that were not influenced in addition to those that were. The laboratory conditions were carefully controlled regarding the genetic purity of the fungi and the composition of the culture medium, the relative humidity, and the conditions of temperature and lighting.

The control petri dishes and the influenced dishes were treated identically, except for the negative intentions directed toward the latter. A person who was blind to the details of the experiment handled various manipulations. The influences simply took their stations at the 1.5 meters and were free to act as they saw fit for their own concentration. For 15 minutes each subject was assigned five experimental and five control dishes. Of the ten subjects three to six subjects worked during a session, and there were nine sessions.

[http://www.religiousresearch.org/fact\\_to\\_faith.htm](http://www.religiousresearch.org/fact_to_faith.htm)

Dr. Loehr was the ideal leader of these laboratory investigations. He directed a controlled experiment on the effects of prayer on the growth of plants. 156 people took part in this project over a 3-year period, performing over 700 experiments, using more than 27,000 seeds with about 100,000 measurements. The results were outstanding, and proved that prayer is effective. These experiments were written up in newspapers across the country and published in a best selling book by Dr. Loehr, *The Power of Prayer on Plants*, (Doubleday, 1959).

## More - Putting BLISS & ECSTASY Science into <sup>162</sup>PRACTICE!

### but first - WHAT ARE PEOPLE FOR??

It was very natural that you were born into this world with some burning questions. What is the PURPOSE of LIFE? What are PEOPLE FOR? How do you become an ANGEL? How do you become a STAR? How do you become a Djedai knight? How do you RAISE THE DJED? Why do people have to DIE? How come some people can come back after they are dead and TALK to us? Is it really true that RADIO COMMUNICATION has been done with dead people? ( Yes - it is quite common-& understandable <http://www.worlditc.org/> )

It really is true that you were bom into this body with some bigger purpose. And it is also true that most of Earth's religions have been claiming to KNOW this purpose for thousands of years. What is NEW information- is that now - understanding how the DNA in your BLOOD makes GRAVITY during BLISS - we can finally use SIMPLE SCIENCE to answer all these questions!

The simple science actually AGREES with most of religion. What Christians call GRACE for example is a vague imprecise name for the skill to move inside and out without JERKiness so as to hold an electrical charge field. Moving with the quality of GRACE is actually something you will later learn about when they explain the CALCULUS of how to SMOOTH a CURVE! This is precisely the right geometry of movement - (GRACE-CHARGE -ful) to walk up to bliss. ... Otherwise you might become a JERK! The smooth and gently flowing quality of movement IS actually what allows your body to gather and not bleed the electrical charge field called SPIRIT. Remember the true origin of the word spirit - is 'to SPIR-al IT'. This is truly the only way CHARGE is sustained - otherwise the spin dies.

Let's take our questions in order.

The purpose of life is to create a coherent charge 'envelope' or field effect around your body which becomes immortal (sustainable). No one can argue with this statement of purpose - because electrically there is no other possibility of immortality. The only way out of here - is to make a 'water pistol' or 'squirt gun' out of your blood DNA to get you thru the speed of light - into stars. Otherwise you ... are dead!

The neat thing is that it FEELS so kool when you get this charge envelope working - you tingle with bliss - you become 'telepathic'(read minds)- and begin to steer the weather with your feelings. All this is simple science. Calling it magic is obsolete - because it is not a mystery. It is not a mystery that the charge field of your human body will create your weather. You expect that clouds will choose to 'precipitate' (vapor to drops) where charge gets folded into nice envelopes. Making bliss in humans is exactly that charge folding process.

Sure- you could say the purpose of life is serving others - and the purpose of life is to save your soul. But now- we know what your soul IS . Your soul is the electrical field around you that you MIGHT learn to sustain. Keeping that together requires no miracle worship -OR religious personality worship (very DIS-empowering). No - keeping that electrical field whole and STEER-able - requires understanding the PRINCIPLE of the electrical field! And acting to support the principle of LIFE! This is the same as knowing how to attract that charge. Serving others is a way of attracting charge - because the FIELD in DNA is constantly checking with the HOLY COMMUNION in it's CORE! This means that each time you trip over something that serves ALL of DNA - then you are going to feel a lightning bolt tingle of extra CHARGE from inside.

You feel a TINGLE -reward for finding something SHAREABLE. Your hair stands up sometimes - because you just became a FRACTAL ATTRACTOR for CHARGE ! - by COMPRESSING well. Sometimes this is called an ANGEL HUG or a WARM FUZZY or a JIMMY WILLIE. yYou 'feel your hair CRAWL' with charge. Moments of great REALIZATION are electrical. Because life is electric.

Charge compressing = information compressing = awareness compressing. Things that are fractal compress best. Love is fractal because it makes your inside look like your outside. Then the whole world falls into you!

Pine cones are very fractal.



A pine cone doing a great job of sucking in voltage from gravity ( called LIFE FORCE ) in a pristine forest knows PRECISELY how to attract charge. The pine cone arranges its parts into self-similar FRACTAL pattern. This starts the implosion. If YOU understood how to be supported by this LIFE FORCE - believe me - you would NOT choose to live in a metal building in bad air and noise. These bad (not-EMBED-able) waves cause the charge to bleed (your aura to leak) in you and so you start to look old and not TWINKLY.

The purpose of this section of the book - is to help you begin to make a plan to re-invent your life around these principles which will keep the BLISS / ECSTASY of CHARGE in your body. This is the CORRECT and only REAL meaning of the old saying "BEING - IN -CHARGE!".

First tho - let's continue with our fun question. We just re-did the Monty Python- MEANING OF LIFE question. Now let's do the WHAT ARE PEOPLE FOR? question. This is the famous question for the hero in Kurt Vonnegut's book BREAKFAST OF CHAMPIONS. Our hero is sitting at the bar drinking whiskey for breakfast (The Breakfast of Champions?) - and suddenly in a moment of blinding realization- decides to ask the bartender: WHAT ARE PEOPLE FOR?

The way I like to start talking about - "what are people for?" - is to **pretend you were an ASTRO-PHYSICIST (a scientist who studies stars). Now suppose the young child of this scientist were to look up into Daddy's eyes and say sincerely - AM I GOING TO GROW UP AND BECOME A STAR?**

**From my careful study of the science and physics of HOW the DNA in your blood can make gravity from BLISS - it is now clear that the scientist father MUST -in truth - answer YES! ... IF you follow your BLISS.**

Scientists who study how star system's go to so much TROUBLE to keep planet's like EARTH able to support life - have come to NAME this principle. They call it THE GAIA (pronounced like GUY-a) HYPOTHESIS. This means that stars and planets work hard to keep genepools (people) alive! Now why would stars go to so much work to be mother's to races of people?

It is simple- races of people - can produce the field effect of stable gravity which makes star birth possible! Of course most scientists are not ready for this yet - but all the evidence is already collected. DNA is fractal (based on Golden Mean ) - you saw the pictures. Blood DNA is therefore able to compress into ACCELERATION the CHARGE of your life memory. This is how you make gravity in science (gravity is acceleration of charge). So this explains the weight loss at death's instant and so on. This also explains Uri Geller's measurement that focus in human attention can reduce by measurement nuclear radiation. (Radioactivity -like consciousness bleeding away - is fractality in need of repair).

We were designed to become STARS! This is going to sound a whole lot less theoretical and un-practical the first time you open your eyes inside a BLISS dream and actually SEE thru the eye of the SUN. Go look at the hundreds of solar shaman who have reported intensely hundreds of such personal experiences - see - SOLAR HEART COMMUNITY at yahoogroups.com . (I'd like to thank Susan for helping us start this thriving community).

This book is to get you ready. You are going to be surprised how soon you are going to be steering the sun. You see the Sun cannot survive her upcoming peak sex experience (Orgasm for the Sun) without us - without you! The Sun's sex experience (orgasm) is called RAPTURE by Christians. It is called THE SOLAR MAXIMUM by scientists. You and me - we know it as a BIG COMPRESSION WAVE - coming from the SUN - testing rightly for what is SHAREABLE!

Ancient books like the Mayan have been telling us for generations that we were designed to become SUN Gods. (Vairococha / Wirococha). It is too bad our scientists have waited so long to understand the physics and science which makes the Maya correct.

“Unless the DREAM-SPELL (charge field) of the OLD ONES (ensouled) - is ALIVE AND AWAKE in SYMMETRY SPACE - Earth will be BLOWN AWAY in the MAGnetic WIND OF THE SUN”. (Mayan prophecy - slightly adapted).

The solar maximum (sun orgasm) is scheduled by the Mayan Calendar (solar science) to be ongoing from now til 2012. You won't have to wait til then - because the compression wind is speeding up. Here are some ways to tell that charge compression is testing for what is shareable. 1. The rate at which people die is faster now and also more people are going insane more often. At one level, to be insane is a name for the electrical field of your mind getting leaky and bleeding. This is (measureable as) the loss of COHERENCE.

For those who have learned how to become shareable and not need secrets- they become compressible. This means they can turn compression (the squeezing in the solar wind of CHARGE) IN to acceleration. They will feel the solar maximum (the ‘rapture’) as bliss. (that is charge and info compressing beautifully). This also means that these people will begin to understand how to re-arrange their lives to ACCEPT this added squeezing without making heat. They will eat live food, live in quiet nature- away from metal buildings and electrical smog - and learn to arrange the magnetism around their homes into fractal and squeezable shapes (we will soon talk about the SCIENCE behind FENG SHUI). This is where we are leading this talk about hygiene. To do the things necessary to be ‘nourished by spin’.

On the other hand, those who keep more and more secrets - and keep trying to store memories which are not shareable in their bodies - for them - the squeezing charge of the RAPTURE will produce agony. This is because when you try to compress things which are not able to be compressed in a fractal (non-destructively) YOU MAKE HEAT. This is the science behind the FIRES OF HELL idea of Christians. If your living area is full of metal and electrical pollution and bad emotions - then when the time of the great squeezing of the suns charge comes - there will be hell fire. This means - that destructive interference among waves happens if you do not arrange everything to be fractal or self-similar. This process starts in your heart - we can measure when your heart's music (EKG- electro cardio gram) gets squeezable. This happens when you choose Golden Mean in your heart's singing. (.618 on the HeartTuner screen). The Golden Mean we learned about in this book - is the solution to infinite NON-destructive squeezing. This is the important problem Einstein could not solve - which YOU must solve- in order to get immortal. When science people talk about heart's they say that HARMONIC INCLUSIVENESS (this means the most number of DIFFERENT notes) in your heart predicts who lives forever. (In medicine terms this is called Heart Rate VARIABILITY or HRV - when HRV is harmonic inclusive / fractal or rich - then chronic disease goes away - see [goldenmean.info/dardik](http://goldenmean.info/dardik) ).

Golden Mean solves the problem of how to get lots of different waves into ONE place - PLUS have them all be COHERENT (that is fit together without fighting).

The other neat thing is that this idea that being HARMONICALLY INCLUSIVE (the most number of different waves fitting into ONE) can be used to predict the VITALITY or LIFE in ANYTHING THAT LIVES! ( see [goldenmean.info/biophoton](http://goldenmean.info/biophoton) ). Golden Mean ratio - is the perfect way to get the most different waves to fit into one squeeze. This actually became clear when we learned that perfect plant branching is based on Golden Mean. ( Called PHYLOTAXIS - [goldenmean.info/philotactics](http://goldenmean.info/philotactics) ). Perfect UNpacking - for plants- is ALSO the perfect geometry of PACKING / compression - in general- in principle.

-

Now lets talk about our next question: **How do I become a Djedai Knight? and - How do I raise the Djed?** (We will cover how to raise the DEAD in the advanced course). Becoming a Djedai Knight and raising the Djed are similar. In both cases the key is being able to PULL THE SWORD FROM THE STONE. The SWORD symbolizes linear energy which means light or energy that moves in a line. The stone is what happens to energy when it goes in circles. Energy moving in circles stores a little bit of INERTIA - like a gyroscope. Because energy in a circle stores this momentum - it is called MASS or MATTER. So GOD or the CREATOR is the one who learns how to trick energy to go into circles. This is because rotation (moving in circles) is the only creator of both MASS (or MATTER) and TIME. Time like matter or mass only happens when and if a wave learns to go in a circle. (Time in fact is only a name for counting how much rotation just happened). When the same energy comes out of the circle and goes once more into a line - then it is no longer called MASS or MATTER any more.



In fact you could rather joke about this - and say that- if it doesn't go in circles- THEN IT DOESN'T MATTER. (There is more to this joke- According to this science - there are indeed ONLY 2 kinds of MATTER: MATTER - and DOESN'T MATTER).

If you are happy with this logic - as science suggests- then becoming GOD or CREATIVE is the scientific process of discovering WHAT it is that keeps a wave in a circle instead of flying out. This as a question which current science actually has no answer to. Current science says it is gravity that keeps the wave in the circle - creating the INERTIA or momentum stored - called MATTER. This is about as smart as saying explaining to kids that the cause of light is the sun - rather than explaining HOW the sun makes light.

The cause of the attraction back into the center of the circle of mass - which physics labels gravity - is actually unknown to physics. In other words - no one in physics has yet even BEGUN to answer the question - WHY DOES AN OBJECT FALL TO THE GROUND? Current science is very arrogant - pretending to tell people what living is for (scientifically) - when scientists clearly DO NOT KNOW why anything even falls down. **Biology & it's bliss and death process are in fact CRITICAL to maintaing the forces of gravity!**

Of course saying that the cause of objects falling is GRAVITY - is about as stupid as saying that the reason birds fly to warmer in winter - is INSTINCT. Sometimes - it is not only useless to simply give something you don't understand a name (like GRAVITY or INSTINCT)- it is actually DANGEROUS. This is because naming your stupidity about how birds know something - INSTINCT- actually could give the dangerous idea that you understand it. When in fact - you don't even have any meaningful idea of the principle. The same is rather true of GRAVITY for scientists. Altho they have thousands of books on how to measure and calculate the force of gravity- they still don't even have any idea of where it comes from or what causes it. This is the kind of arrogance that causes people to die too soon. They think they understand gravity- but they don't. They think they understand LIFE FORCE - but they don't.

The TRUTH is - that GRAVITY is caused by waves IMPLoding. Einstein said that infinite NON-destructive compression is the cause of gravity. He just could not figure out- how to picture - INFINITE compression.

This is called - the Holy Grail - the PICTURE.(page 171). (animated at [goldenmean.info/grail.html](http://goldenmean.info/grail.html) )

It is the shape of waves in GOLDEN MEAN RATIO.

This invites the KIND of squeezing - that turns - COMPRESSION in to ACCELERATION. We talked about this. In this way- adding and multiplying a wave speeds - CONSTRUCTIVELY- produces the speeding up of those waves. You understand now that this producing of ACCELERATION or speeding up - from COMPRESSION - IS THE SOURCE OF GRAVITY. (Science is very clear that gravity and acceleration are the same thing). So finding this shape of squeezing that will turn (CHARGE) compression into acceleration - is the secret of gravity. When the squeezing turns compression in to acceleration by rose like pattern (fractal) - then the speeding up of charge - finds a way out thru the speed of light. Opening this plug in the drain (like in your bathtub) causes suction. This suction out thru the speed of light is called GRAVITY.

This is proved when we put little capacitors into this GOLDEN MEAN pattern on a cone. You produce gravity - and make rocketry and even gasoline obsolete. There are some limits to this source of power from gravity and source of gravity from electricity. We will come to those. Meantime we strongly suggest you avoid the error of calling this FREE ENERGY - because it is not FREE at all - [goldenmean.info/notfree](http://goldenmean.info/notfree) . Mother nature took billions of years of biology climaxing with your emotion of bliss- to make up the gravity field of Earth. She would not be happy if we bleed this away without returning the favor. Coherent Emotion Feeds the Earth (Gurdjieff).-more on how emotion makes gravity- see pictures page 135.

First- let us get back to our principles here.

Now you see - that only the self-similar or fractal - or rose-like pattern of waves of charge allows us to make the implosion of gravity. This explains why the inside of the atom (the nucleus) is self-similar or fractal to the outside (the patterns of the electrons). The amount of this self-similar - ness (or fractality) tells you how much gravity is present. Gravity quantifies the amount of successful collapse / acceleration thru center by implosion. The charge which gets thru the speed of light there creates SUCTION called GRAVITY.

What is cool is that as more kids come to understand this - they can embarrass the scientists in to understanding it.

This is absolutely important because whenever nature tries to make LIFE or make GRAVITY (like roses and pine cones) she uses this same FRACTAL or GOLDEN RATIO based - pattern making. So making LIFE and MAKING GRAVITY - both require understanding the PATTERN - or SYMMETRY of ROSE like self-similarity - or FRACTALITY. This is what allows charge to compress or implode to make MASS and to make LIFE.

(Read about this magic pattern -Golden Mean Spiral -Yellow Brick road - to making alphabets and symbols - in LETTER TO AARON - early in my book ALPHABET OF THE HEART- goldenmean.info/book1 )

Now - why did we have to tell you this story about how stupid Earth's current scientists are about life and gravity? Especially since we were just telling you how to RAISE THE DJED and BECOME A DJEDAI KNIGHT.

Well - remember - we said it was tricky to get a wave to stay going in a circle- but if you learned how - then you get to be GOD. This is because creation of MASS or MATTER (GOD's job - which you now take responsibility for) - happens only when waves are tricked into staying in a circle. We have revealed to you that producing IMPLOSION by patterning waves of charge into fractal or pine cone or rose petal like shapes - IS what makes GRAVITY and LIFE. So - in order to keep waves going in a circle - IMPLODING into LIFE and GRAVITY- you need to know this magic pattern.

Here is your little experiment - somewhere where seeds could grow - try this. Take 25 quick growing seeds in EACH of 2 little dishes with water. Find a bunch of stones or rocks that FEEL good. Arrange them into a pattern on the ground that looks like a laid out rose or PINE CONE.. SOMETHING LIKE THIS:



This is the principle of a good STONE LABYRINTH.

Image thanks to

Taffy Lanser

goldenmean.info/  
taffy

Now put one of the dishes in the CENTER of the pattern. Put the other dish somewhere near which has the same temperature and light - but NOT the effect of the stones.

The stones are little CAPACITORS- especially if you are clever enough to FEEL into which ones hold charge - this is called PARAMAGNETIC - limestone and quartz based stones are good / PARA magnetic - sandstone like stones are bad: DI-magnetic. Paramagnetic stones bend magnetism like a lens or prism , while di-magnetic stones like sandstone break up or fractionate magnetism like a sieve or a strainer. Paramagnetic stone is critical to fertility because LIFE is made of the pretty pictures made when magnetism is bent in an orderly way! Sandstone will usually break up magnetic lines inside- not built by fire inside- and so does not respond as well to the ordered magnetism and charge distribution required to respond to your AWARENESS!



NEXT - after about the same amount of germinating time (to germinate means to sprout)- COUNT the number of seeds in the 2 dishes. If the seeds in the dish - which had the benefit of rocks arranged around like rose - grew better - THEN YOU PROVED A PRINCIPLE WHICH SCIENCE MUST LEARN!!!! (Otherwise life on this planet is going to die).

You see- where you compress charge correctly - (implode) like you did with the stones in the right pattern- you CREATE LIFE.

If you really get into this project - called - proving the symmetry of LIFE.. Here are your next experiments: Make your layout of nice stones a bit bigger and put them around a compost pile. (Every garden should have one). You should be able to make the temperature of the compost pile HOTTER (more life) by surrounding it with CHARGE COMPRESSION.

Your last little experiment if you can: Take the same dishes of seeds - and see if you can find 2 containers to imitate 2 houses. (Also works if you have 2 actual houses or model houses). The thing is - one container or house must be made of Biologic material like WOOD or NATURAL FABRIC - etc., while the other model or container - or house - must be similar - EXCEPT the other one must be made of METAL. Good to test aluminum or tin - because these are VERY HURTFUL TO LIFE. You see - metal causes capacitors to bleed charge- and LIFE TO BLEED LIFE. This is why a square metal refrigerator is such a terrible place to put food. It is a very bad leaky capacitor. It cannot hold charge. two things cause charge (LIFE) to leak away - one- is sharp corners. Two- is material whose molecules never got pushed into fractality (LIFE SUPPORT). Metals kill LIFE when they surround LIFE because their molecules and atoms are FAR from FRACTAL.

So the thing you need to do - to prove to arrogant scientists- to stop killing people and life by using metal and aluminum around LIFE - is this experiment:

Put one of your seed dishes into the wood or natural house model and one into the metal house or metal model. Then again after waiting for germination - COUNT HOW MANY CAME TO LIFE.

If more of your seeds died when placed in the metal environment or place - then go tell your parents now never to put you in a metal building again! It probably would be good to let them put scientists who are too stubborn into the metal buildings - because a little dying sometimes is needed to provide BIOFEEDBACK to them.

— end of experiments part for this section—

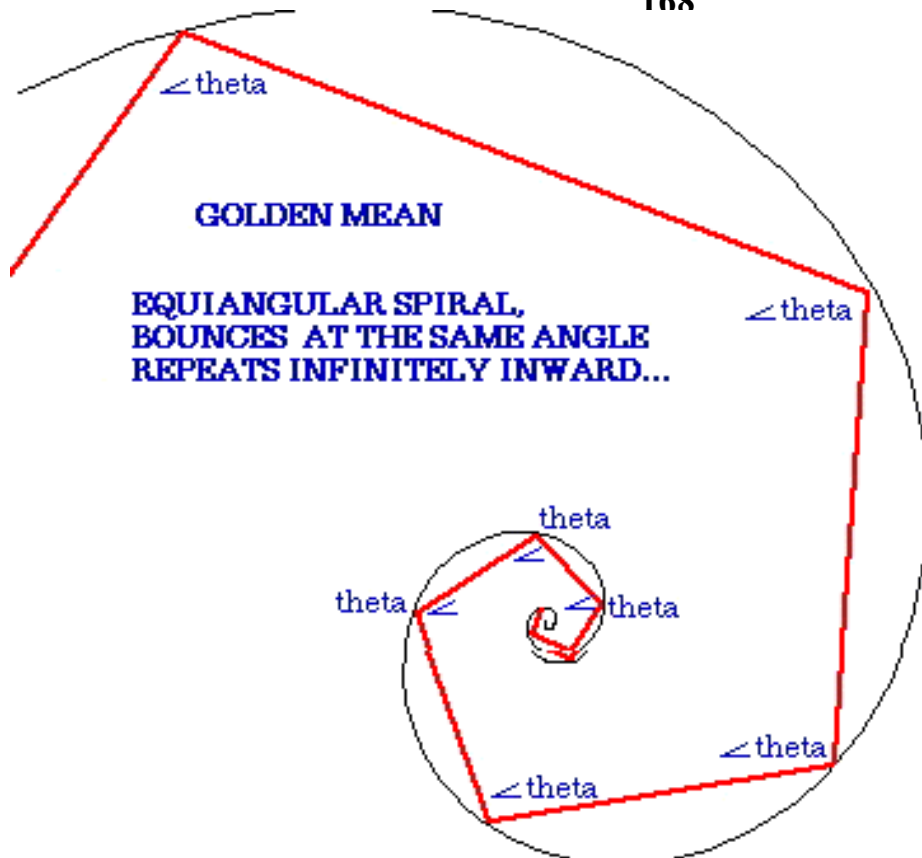
WELL - the other side of this pretty coin - of our problem - how do we get waves IN to circles (Sword IN to the Stone). IS..

How do we get the Sword -FROM - the Stone. This is the problem how to get the Energy into a LINE coming back out from the CIRCLE. This is VERY important because this is the answer to our question- HOW TO RAISE THE DJED. The DJEDAI KNIGHT is the one who can pull the energy right out of the circle (mass) back into the LINE - PURE ENERGY. This is very kool because this is the power behind (Star Wars:) Luke Skywalker's (and Arthur's) SWORD!!!

The way the energy comes OUT of the circle (the stone) into the LINE (the SWORD or the DJED) - is the same way it went IN!!!

You need to tempt it. The way you tempt the energy to come out of circles back into energy from mass (circles) - is you provide a SPIN PATH. The name for the spin path which allows mass to become energy again (circle waves- as mass or matter- to become energy waves as waves in a line).. is the SCIENCE called OPTIMIZED TRANSLATION OF VORTICITY. Notice these fancy words just mean the best way to change from rotation to lines while getting in and out of VORTEX or TORNADOS! This is going to become our little teaching on how to STEER or control TORNADOS.

Notice - in geometry - that the name for this way of getting spin in and out of VORTEX - is made perfect in: (you guessed it )- THE GOLDEN MEAN SPIRAL. This is the perfect case of what is called the EQUI ANGULAR spiral:



**Golden Mean Spiral is  
Equi-Angular-  
Means  
Angular Relationship of  
the 'First Bounce'  
recurs In-Phi-Knit-ly.**

**Allowing perfecting of  
SCALE INVARIANCE-  
Wave Guide for Galaxies to  
Send Messages to Atoms..  
Angels to People...**

**This is not just the perfect  
PACK and UNPACK path  
for DNA - this is the correct  
way to die and get born  
successfully (with  
memory).**

This just means a spiral which bounces you AT THE SAME ANGLE - no matter where you run into it! This is how inter-galaxy angels send messages down into little babies. It is like sending a message down a kite string. Remember that this Golden Spiral path - is exactly what charge sees - as it enters the RABBIT HOLE - view from the top - in your bloods DNA! ("Rabbit Hole" is the templar/ south american term - SINTRA-meaning entrance to a worm hole - or dimple compression place - is in "ALICE in the Looking Glass".)

So - where were we? We are steering the energy out of a tornado - and thus becoming a Djedai Knight! This is the REAL meaning of - MAY THE FORCE (the CHARGE) BE WITH YOU.

**TAKE CHARGE! -**

*The moment of BLISS begins with an idea, a picture, which allows waves (of charge or spirit) to become SHAREABLE . It is the PURE INTENTION and thus IMPLOSION PRINCIPLE of this INNER IMAGE - which actually ATTRACTS and INVITES the DJED - the FOCUS- the LIFE FORCE - into you!*

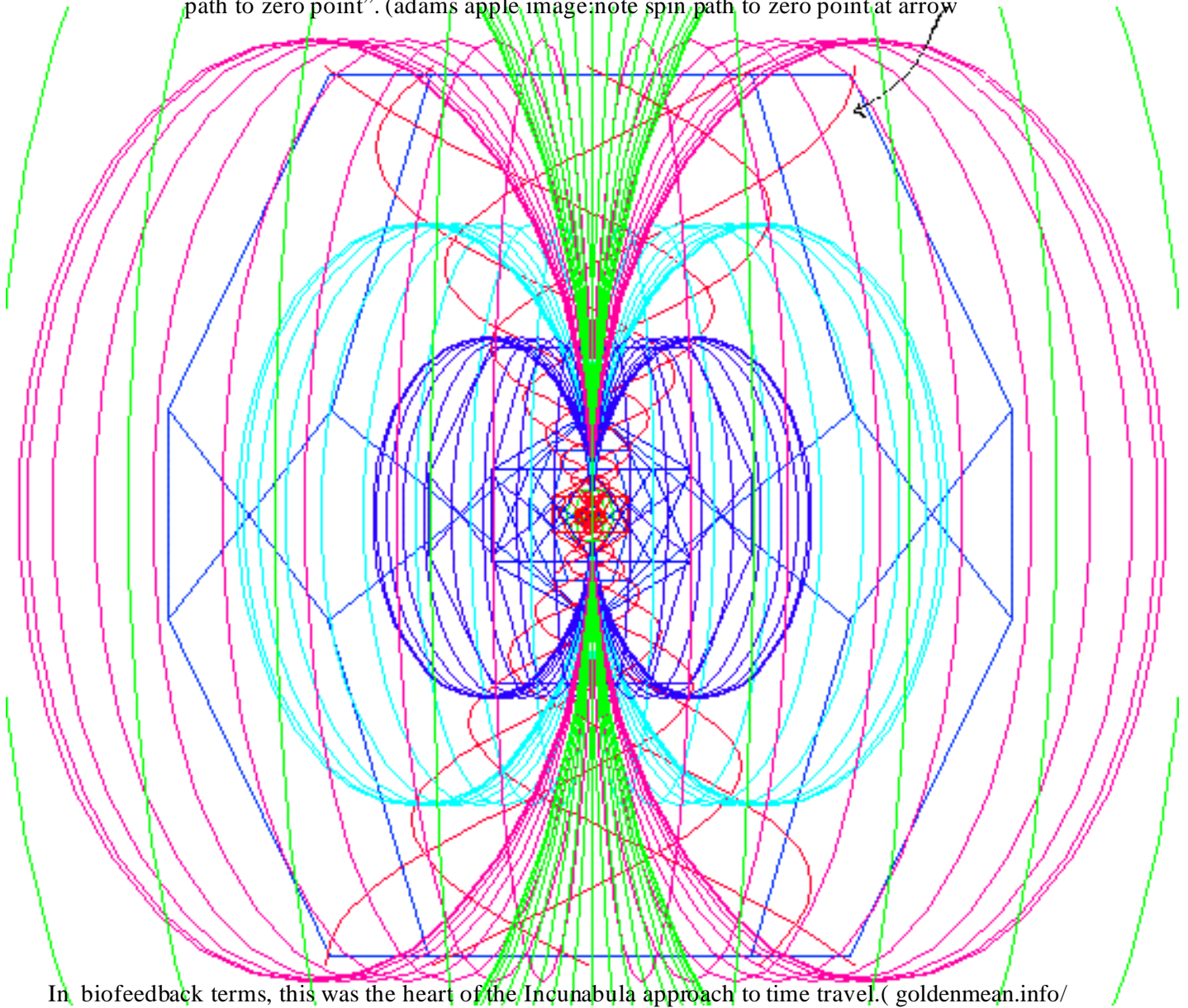
*May the FORCE Be With YOU! -Djedai .*



## Practical Exercises for BLISS.

### Time travel, The Shareable Psyche and Touching the “Zero Point”

The question of inserting your body into BLISS is quite a simple and practical one. Entering through stargates/ time portals is a natural part of BLISS process because the center of your awareness and charge coherence is accelerated by compression. If you think of the images we have shared of a compression algorithm which allows spin to converge continuously toward a common center, a good visualization can be had for this “spin path to zero point”. (adams apple image; note spin path to zero point at arrow)



In biofeedback terms, this was the heart of the Incunabula approach to time travel. ( [goldenmean.info/incunabula](http://goldenmean.info/incunabula) ) The visual biofeedback was fractal spiral embedded images generated from your own internal EEG and micromotion.

Take the wave path of all of your body's biology and squeeze it infinitely by self-reference into a time tunnel. The damanhur.org community calls these 'synchornic lines' of time. The same lines when they compress to dimple - show up as song lines on magnetic maps. (p.101 pic.) The pent and recursive electrical geometry of this was the core also of the pent/deca antennae geometry of Montauk. ( See the MONTAUK books by Peter Moon & Preston Nichols- became the movie STARGATE).

What requires our attention here, is the psychological part of this experience of electrical compression. It is important that we don't view this uncovering of the phi based recursion symmetry of infinite compression, to be only a sterile solution to the problems of gravity, time bending, etc. While it is all of that, it is much more important psychologically and emotionally. It is the key to BLISS!

Try to think of the spin pattern survival dynamic of what happens to the magnetism (and therefore the memory) of flow lines converging at center. The sharing of path space at the convergence implosion moment is a psychological as well as a physical test for what is shareable. This essentially means, that if the genepool's collective wave core is not in agreement with what you feel/think at the moment of implosion (death or shamanic penetrance), then your memories will wave cancel instead of propagate. The cancellation of waves by non-shareable(non-symmetric) interference feels like heat/ the definition of resistance to spin. The same symmetry operations toward centering which when encountered non-resistively (fractally embeddable) feel super-cool (super conductive/non"linear"). **This difference between lack of perfect embedding in a spin field, and perfect implosive nesting, is the physics of fear (resistance to spin), versus love (sufi fractal heart magnetic wings which embrace all of spin.)**

Another useful metaphor might be the central modulator of the universal radio station. In order to get voices through the squeeze play of the transmitter, while at the same time talking to all the voices of this galactic sector, a certain discipline around what could be modulated or enveloped onto the common carrier wave might be necessary. The common carrier wave geometry for universally transmissible info patterns, would be the wave envelope of perfect embedding, or nestedness. Only fractality is infinitely compressible and therefore infinitely shareable. This 'organic' symmetry discipline of all of LIFE is your ticket to its common modem/ radio.

This is well depicted in Irving Dardik MD, article in Cycles magazine on the direct relationship between onset fractality in heart rate variability and health in general. Basically, the wave envelope of what constitutes the perfect changes in heart rate looks like a perfect fern tree folded fractal. The more fractality or embedding allowed into the heart in the still point (zero place) between beats, the more the infinite spin context of the universal song could waltz into the electricity invited into the body by the perfect embedded beating heart. ("Heart Waves" in Cycles Magazine, Dec. 1996.) - see [goldenmean.info/dardik](http://goldenmean.info/dardik)

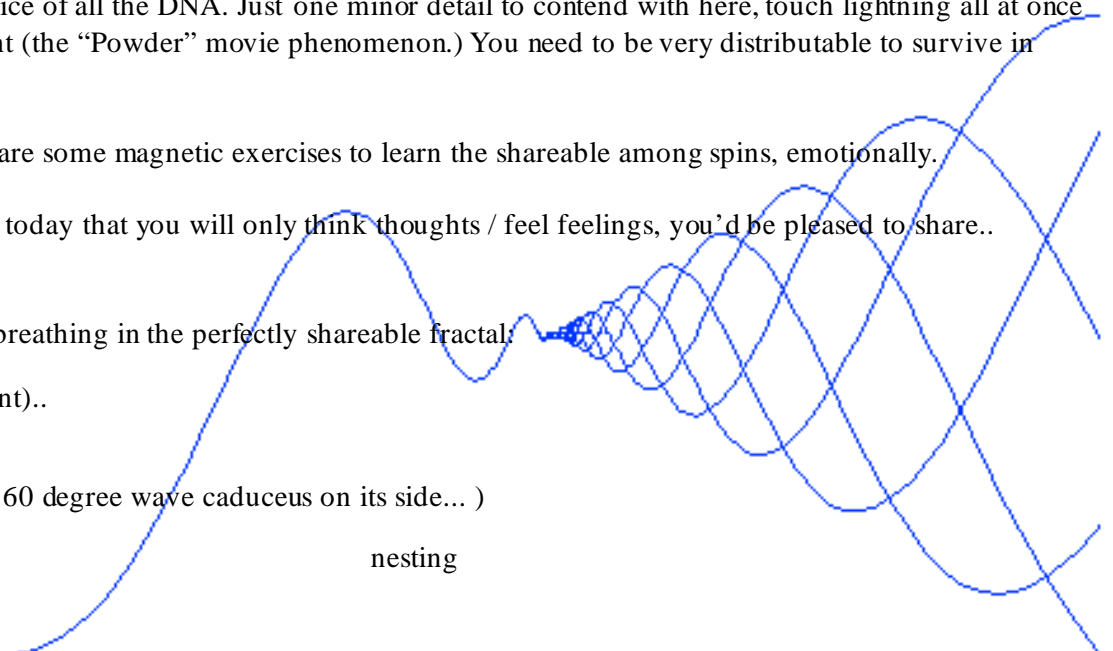
The overall quality of this psychology of where spin lives, is like the heart surgeon who cannot but bear to reach in and touch lightning because it is so exciting. In the lightning the spin is so dense that awareness or self embedding exists on a new level. Therefore it is quite the perfect place to talk to god/ or if you prefer the collected electrical voice of all the DNA. Just one minor detail to contend with here, touch lightning all at once and you get quite bumt (the "Powder" movie phenomenon.) You need to be very distributable to survive in memory.

So what follows here are some magnetic exercises to learn the shareable among spins, emotionally.

1. Decide for yourself today that you will only think thoughts / feel feelings, you'd be pleased to share.. infinitely.
2. As you do this, try breathing in the perfectly shareable fractal:  
(spin path to zero point)..

(Insert picture perfect 60 degree wave caduceus on its side... )

nesting

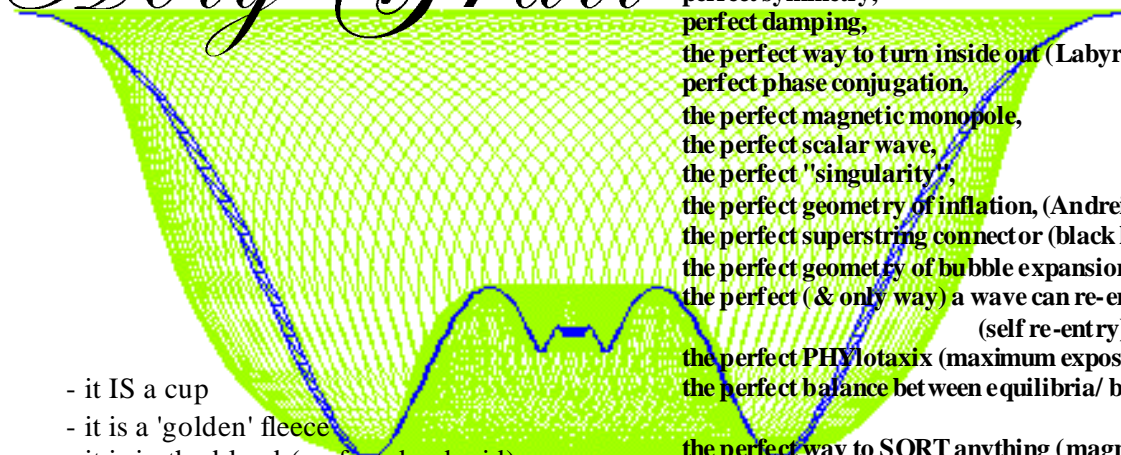




The path for breath to still nest.  
 The path light sees on it's way in to DNA when  
 braided in perfected embedding/love.. (The grail)

Holy Grail animated: [goldenmean.info/grail](http://goldenmean.info/grail)

# Holy Grail

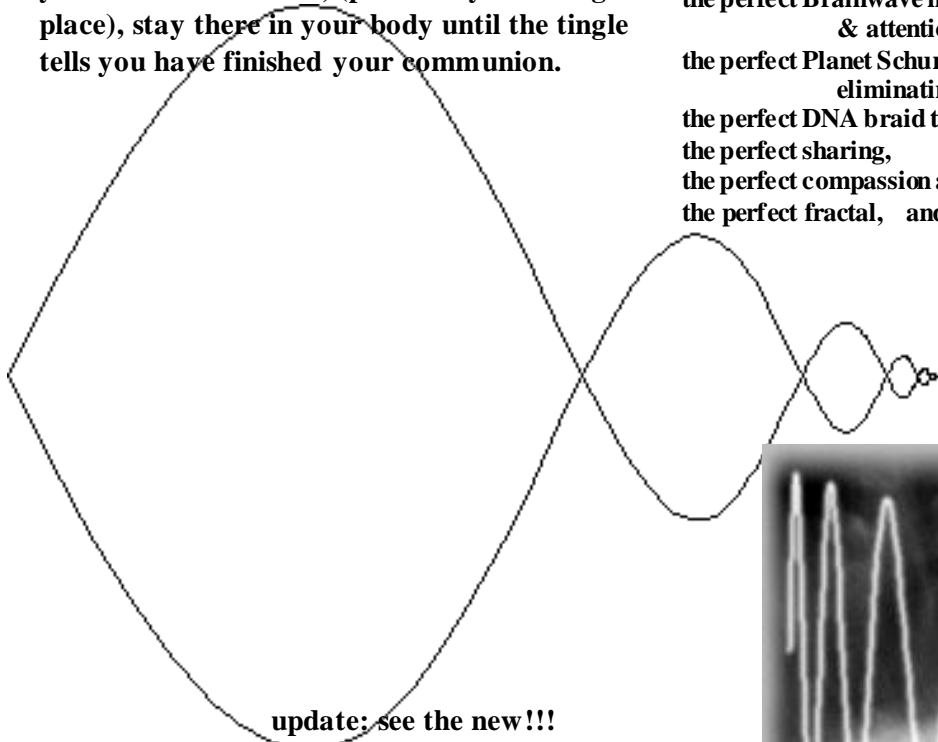


- it IS a cup
  - it is a 'golden' fleece
  - it is in the blood (perfect dna braid)
  - it DOES result from pure intention..
- ELECTRICALLY & EMOTIONALLY  
 THE SHAREABLE WAVE

This In-PHI-knitly constructive MAGNETIC WAVE INTERFERENCE perfectly describes at once the PRINCIPLE of:

- perfect spin density,
- perfect information density,
- perfect recursion,
- perfect embedding,
- perfect implosion,
- perfect gravity ( $G=C*\Phi^!$ ),
- perfect data compression,
- perfect connectivity,
- perfect symmetry,
- perfect damping,
- the perfect way to turn inside out (Labyrinth),
- perfect phase conjugation,
- the perfect magnetic monopole,
- the perfect scalar wave,
- the perfect "singularity",
- the perfect geometry of inflation, (Andrei Linde)
- the perfect superstring connect or (black hole),
- the perfect geometry of bubble expansion,
- the perfect (& only way) a wave can re-enter itself non-destructively (self re-entry),
- the perfect PHYlotaxix (maximum exposure/minimum super position),
- the perfect balance between equilibria/ between liquid/crystal,
- the perfect way to SORT anything (magnetic, liquid or gaseous),
- the perfect way to SCALE anything,
- the perfect way to SYMBOLIZE (or embed) anything
- the perfect way to get physical (PHI-cycle),
- the perfect (and only) SELF ORGANIZING PATH OUT OF CHAOS,
- the perfect (and only) SPIN PATH TO THE ZERO POINT,

Here the breath moves in and out in the geometry of perfect damping, or the perfect way to approach the icy stillness of oneness. The depth and the duration of each adjacent breath get smaller by ratio PHI (golden mean).. When you reach the stillness, (preferably in a magic place), stay there in your body until the tingle tells you have finished your communion.



- the perfect self-awareness,
- the perfect pinning,
- the perfect intent,
- the perfect time wormhole (antennae geometry),
- the perfect HeartBeat harmonic signature for disease resistance (Irving Dardik, MD "Cycles Magazine"),
- the perfect Brainwave harmonic signature eliminating addiction & attention deficit (Wuttkle Clinic),
- the perfect Planet Schumann harmonic signature eliminating climate chaos & atmosphere loss,
- the perfect DNA braid to make "soul".(spin memory to survive death),
- the perfect sharing,
- the perfect compassion and love,
- the perfect fractal, and... the perfect grail:

update: see the new!!!  
 "Caduceus Breathing Trainer"  
 at [www.heartcoherence.com/caduceus](http://www.heartcoherence.com/caduceus)



3. Do an experiment whereby you change an otherwise difficult situation by breathing in the phi Sentic of the perfect wave form for love (embedding). Often when we find something messy has snuck up on us, we breath in the perfect “jerk” of fear. This is a sharp in breath followed by NO outbreath. This is the breath of fear, it’s halt of the flow of o-x-y-gene or phi-re, says: “stop the world, I wanna git off”, which literally asks all spin to stop. It is the mind killer because it is the recursion killer.

So the breath of love, which invites ALL of spin.. is one (picture sentic love wave here), where the point of maximum inrush is reached at the .618 point in the duration of the gentling breath. This is then the distance between fear and love, in a breath.

4. Do the above two experiments in learning embedding/compassion, except instead of moving your breathing in and out, in the two depicted patterns, instead use these two road maps to embedding to change the pressure in a hug or squeeze over time, to express feeling intentionally.  
(Clues to tantra also.)

### 5. Try arranging your:

- a.) magnetic stones
- b.) closest meditating friends
- c.) back yard or church
- d.) favorite memories
- e.) sufi dance or tai chi or flame in go..
- f.) the shape of your inner FOCUS!!

...into the following perfect pent fractal pattern - (like a rose or pine cone)..

Then.. feel the rush of “cryst-all-eyes-zing” awareness where all waves agree.

Pretend you were arranging the cathedrals in Rennes Les Chateaux Grail Country.. Pent Nest to Fractal to Star Habitation

*Climbing the ladder of symmetry is the tree of el-eye-phi*

-

Next, close your eyes, create a container for your passion in this more than mental vortex attractor, and lucid dream.

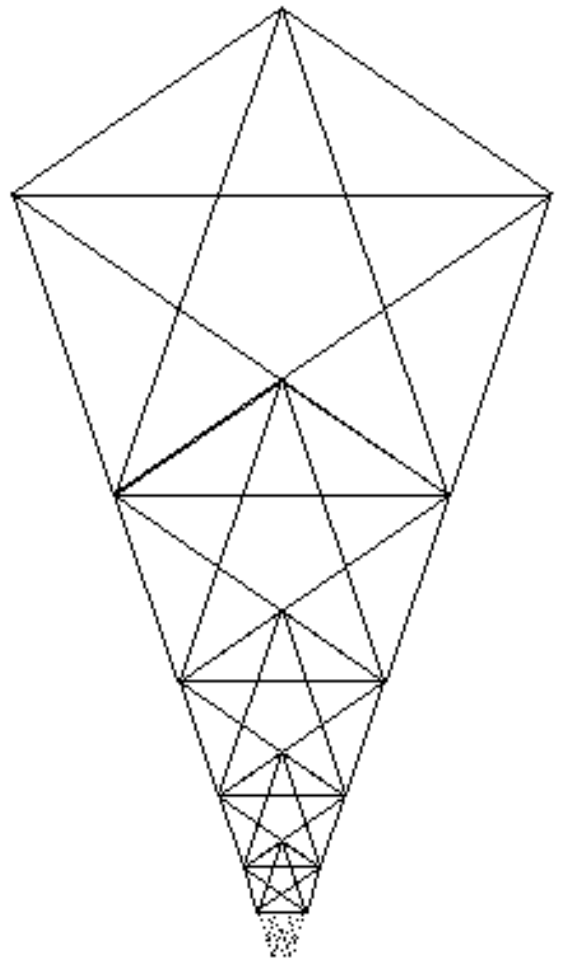
—

Approach, just up to the point you begin to tingle-just til the point the charge becomes uncomfortable..

then focus breathing and focusing on your heart, approach is the point of approach to which comfort can be maintained any closer?

stand in hex and approach

then stand in pent..





Celtic and african dance for ecstatic access: five beats against seven beats,

compare with five spin inside vs seven spins outside in [heart of the sun..](#)

use hands for 5 beats per cycle, move feet in seven beats, using heptagram as foot placement, alternate first foot around the heptagram.

now you are ready for the final step in the tetrahedral fire breath, where the star tetra is nested in the dodec.. producing the merkabbah moment,

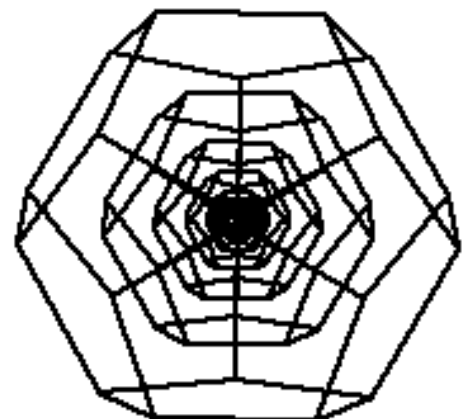
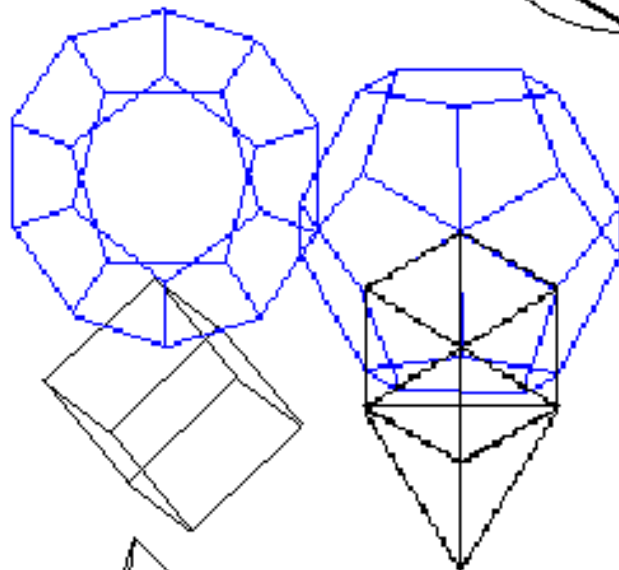
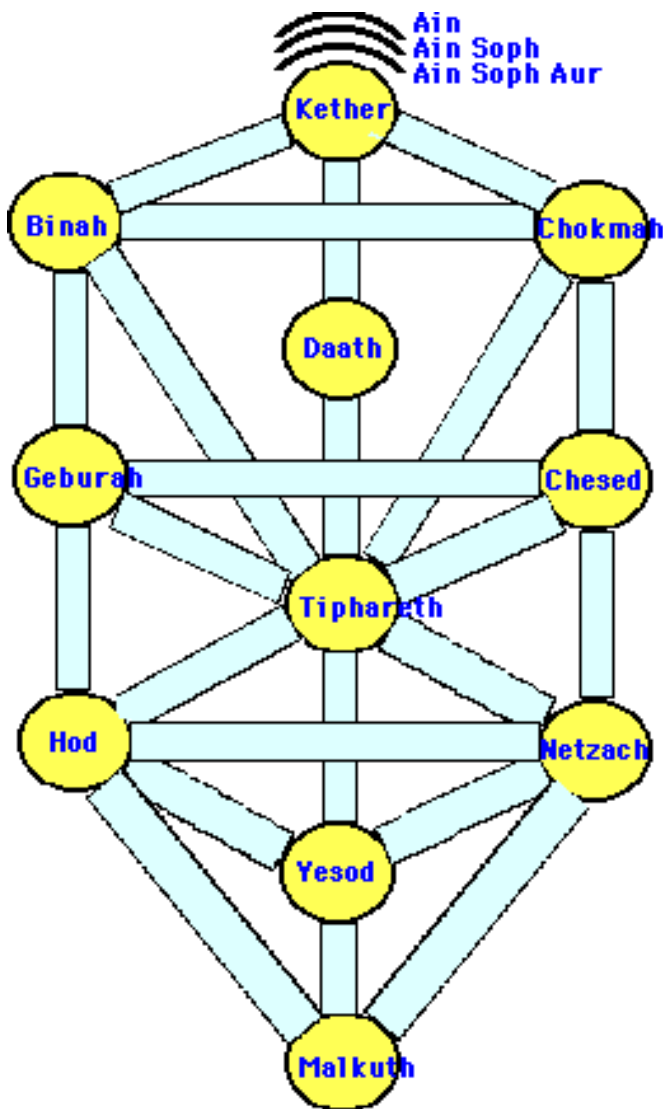
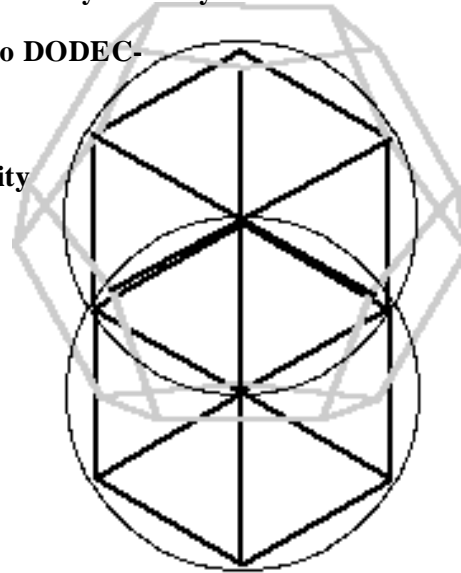
Try- tilting the tetra cube ( tetra hedral Fire Breath) that you vision around your body -

in the next dimension - by using the 32 tilt to nest that cube into DODEC-

read [goldenmean.info/merkabbah](http://goldenmean.info/merkabbah)

And - please do not underestimate the absolute necessity of hygiene discipline around lifestyle and diet: -

- [Nourished by Spin: The Twinkling Eyes Lifestyle.](#)



*by Dan Winter*

The world and memory is made of simple pressure waves which by learning to dance in symmetry, learn to stay alive. We've learned that symbols and 'feeling loves rush' are simple lessons, in how to catch spinning donut fields by their throats in such a way as to eat their spin. People are like tai chi water wheels, who by catching spin in their wave envelopes, can either eventually bend galaxies of light into their wishes, or be completely washed away to death by lack of symmetry/spin/ & share-ability in their waveforms. The choice is as simple as at each moment knowing how to "be nourished by spin" in any situation.

Consciousness = Perfect CHARGE Distribution (perfect distribution = no storage = perfect compression).

**Be Supported by LIFE! - Be IN CHARGE - Embed or Die..**

**Hygiene for Focus / Attention / The Charge that Builds Euphoria and Bliss ..**

**The Highest Form of Information Absorbtion:**

**1. Diet - Live Food, Genetic Diversity (Avoid Corn, Wheat, Soy). DNA gets ANGRY when MONO-cultured. Your body responds with disease causing MUCOUS if your eat ANGRY DNA!**

**During BLISS you need - Quality Protein - Organic Eggs, Fresh Fish. In gentle and appropriate but REGULAR amounts. Avoid Overcooking.. Drink ONLY Fresh Squeezed of Spring Water..**

**2. Hygiene of Environment - Grid Engineering for Bliss: Embedable Magnetism, Increase Sun, Living Charged Air, Eliminate Metal, Magnetic Pollution..**

**3. Move for Bliss: Tai Chi, Eurhythmy, Yoga, Sacred Gymnastic, Sufi Dance.**

**4. Rites of Passage, Vision Quest .. to learn Soul Purpose - Enable Genetic Bliss..**

This letter will be a series of hints, on how to locate the spin which feeds the soul, at every turn of the eyeball. Since spin is only supported by the mirror-like symmetry which sacred geometry teaches, then these lessons could be called sacred geo-metry and.... homebuilding, eating, traveling, loving, dancing... etc. The point is that pure principle shared at the center of all spins, like ever-present lightening, will animate your thoughts and your body, if you know where the spin donut throats are centered at every turn of your road.

First... get to know what it is that both you and the collective mind want. You and the ONE mind both, want to consume AWARENESS. Awareness is what happens when enough donut -shaped pressure waves converge at ONE POINT to become recursive and self-embedded.

The process of locking pressure fields symmetrically enough to get spin centers reaching out to farther and farther horizons of "feed back loops" called awareness is what the electrical structure of the heart and brain were precisely designed to accomplish. Elements of the pressure spinning around farther and "far pavilions", can then be pulsed into you. So your field can then begin to collect data or "sample" the pulses, about what is spinning, even beyond your fingertips.

Awareness happens when recur-sive nesting happens. Recursive nest-ing happens when fields become "self contained". Just because we have named the wave suction like attrac-tive phenomenon we feel when this fractal attractor occurs, "conscious-ness", and "gravity" does not mean that they need to be inherently mysterious.

***Self-Awareness = Ability to Self Refer***

***Golden Spiral- the only path which allows a wave to ENTER ITSELF!***

***- like looking at your hand in order to WAKE UP in a lucid dream.***



*Note* when you are in an airport, whose twinkling eyes you cannot help but look toward. We caught you, you were falling in love with awareness again. The higher frequency content in the spin membrane of eyeballs that do indeed twinkle, is there because the spin could nest. Eyes cannot hold spin if the rest of the body cannot electrically hold spin. The rest of the body, cannot electrically hold spin, if the microclimate cannot hold spin... etc. The point is that **only spin systems which can nest one inside the other, “self-contained” perfectly, like a fractal, can hold awareness.** (*The same way Dr Dardik discovered the fractal heartbeat which heals goldenmean.info/dardik Generalized perfect nesting of wave within wave-is called SUPER-LOOPING.*)

**It is not enough for the eyeball unto itself to be in symmetry, with the structure of its own scale. It only works, if there is a whole nest of bigger and littler spin systems, which can pass their spin (memory) unimpeded up and down between big spin circles and little spin circles (these are technical terms here). The connection between big and little, is ONLY kept spinning when waves discover the solution for how to get from here to there, big to little. This little secret was discovered by waves who did not wish to die, many turns ago. We as people would be well to hear their whisper. These clever waves said, oops continuity of memory/pattern/and spin, is better than interference and death. We will do the little trick required to live forever. We will enter the very “particle”-ar kind of symmetry which makes nesting possible. We will enter the fractal. Waves so efficiently distributed are called CONSCIOUS!**

So the waves figured out that the pattern of the nucleus in geometry had to be the same but littler than (fractal to) the pattern in the electron shells. This fractal recursion and perfect COLLAPSE - between electron and nucleus created the wave suction we call gravity, by making possible sharing and not fighting between the waves on the outside of the atom, and those on the inside. This principle of embedded pattern geometry is also helpful for example if you happen to be a landscape elemental who just fell in love with a people. People tend to be littler than landscape ele-mentals who routinely envelope bioregion wide lightning storms, in their wave bodies, So, the vast landscape angel uses fractality, recursion, to sweep little people into their love. Suppose you made whole mile long stretches of hillside into something which was the SHAPE of people, only bigger. (Like the body shapes in the hills around Glastonbury, England for example). Then you as the landscape angel, could get your magnetic spin, nested down into a people, with whom you might hap-pen to be in love. Indigenous people used this quality of foldedness on the lands gauge.. “el-land-guage”.. to initiate their shamen into the dream time. Magnetic flux concrescing or converging from faces on the land (“simulacra”), into the glands of people, fractal to the lands magnetic fold shape, is an ideal way to get memories the scale of continents, into peoples bodies. Thus begins a physics for aboriginals use of large stone formations as libraries to be accessed at will. This quality of lands shape getting to be anthropomorphic or people shaped, was called “Simulacra” in John Michell’s book by that title. If you want to feel the memory of a whole tectonic plate, visit the center of the Eagle’s brain in the map of central Pennsylvania.. Be nourished by the spin.

The concept of information and energy traveling between structures by virtue of the resonance created between related shapes, is called “morphic resonance”. This spin energy which may include many spectra, while tested in principle, has been considered somewhat magical in physics and information theory (Rubert Sheldrake et al). However, when the elements of charge spectral harmonics, are linked by phase (which pure shape is), we can much better begin to understand how information may travel great distance when complex shapes send spin messages from place to place. These messages may be thought of like the packets on internet destined to mailboxes which match shape codes for routing. Viruses which affect each other at a distance are an ex-ample, they are identified by the infinite series coherent frequency signatures which biological struc-tures/shapes epitomize (“Structural Stability and Morphogenesis”). Since coherent magnetic fields moving BETWEEN frequency signatures, turn out to be gravity, perhaps we should now begin to think of astrology as the science of knowing how to best eat spin.

What does it mean to consult your astrocartography before making any move? We should know how the fractal cascade of gravity’s scalar magnetic wind between frequencies will massage our glands, before we set sail in that wind. We used to say, astrology was not the science of cheating the wind of gravity, it was merely knowing which way the wind was blowing, BEFORE you choose the angle of your sail. This metaphor takes on a nice deeper richness, if we look at Hilarion’s phrase: “magnetism is the wind on which love travels”. Magnetism is indeed the carrier of LOVE!

This is revealed in the harmonics of the heart electricities at love's moment: heartcoherence.com  
 When the heart's harmonic nesting works, then abra-cadabra.. the tree hears the wind. Its what hap-pens when the tree's charge envelope is braided into the harmony of human love...

A wave "mechanic" (geometry) carried the magnetic wind of electricity from the fractal heart to the listening tree. The donut fields gathered to nest by one-pointedness, found that hi leverage still place from which to share life giving spin. The fun part is now knowing that this nice little braid cascade recursion of wave donuts getting their pressures nested to fold all inside out through one slip knot to ... elsewhere, IS EXACTLY WHAT WE HAVE IRREVERENTLY BEEN CALLING GRAVITY. How else could we perceive gravity as going only one way, in but not out? IN order for the spin to GO somewhere, (obviously those gravity waves were not going to their deaths), they must be traveling INTO THE FRACTAL... They know that inside the inside out.. inside the self-contained recursion nest, they will find a place to unpack their spin memories... into even finer detail. Gravity draws the threads of memory through the wormhole vortex , where all fields are unified.. Thus the information/mind of pressure can nest to where they (and the feedback of spin they contain called distributed awareness) could not otherwise travel. THEY GO TO OTHER SCALES, USHERED THERE ONLY BY FRACTAL RATIO. This trip to other scales.. requires an "air" line ticket, namely fractality & recursion neatly danced.

**The practical exercise here is to see if you can track or follow your awareness- the tornado of your inner charge - from the center of gravity in your heart - to the center of gravity of the Earth - to the center of Gravity of the Sun. If you establish the continuity of this wormhole well - before you dream - than you dream LUCIDly and SURVIVE DEATH. The trick is to FOLLOW the thread between centers of compression -like wormholes centering...**

Planets perceive the cascading magnetic lines moving between scales, the increased info density gravity braids, as an erotic bloodstream which biology only serves if people emote coherently and undertake conscious grid engineering. This is a deep and abiding clue to the nature of human/planetary symbiosis, both focused on evolving awareness/recursion. **"Coherent Emotion FEEDS the Earth!"**

Religion suggested - now science confirms: the one unforgivable sin is to blaspheme or act against the holy spirit.. Our great friend Jim carefully looked up **Holy Spirit** in his concordance to the roots of language, and found that this phrase meant sinning against **"rotation,, preventing the "turn" into the "shallow cup"**. **The grail is the name for the cup shape possible when recursion nests...** magnetically, sonically, & optically, it's all the same.- (when pressure breathes a repeating/recursive pat-tern, it is mind). **The holy spirit is the name for the wind which enlivens the magnetic field... when it is nested.** If you sit your house under a 60 cycle power line, you are sinning explicitly against the possible "whole-liness" of this spirit. You will not find your spin informed by the holy spirit there. **The breath of the spirit, is possible only where nested-ness is alive.** 60 cycle power lines were invented in a time when these kids did not understand from whence their bread (their spin) was buttered. Lack of information context (rats nests) in the magnetic lines crossing your bed, accurately predicts like the simple law of messed up prisms, which part of your body will die first. **Death is the death of recursion. Life is the name (is the shape) for the el-turn into the eye (focus) of PHI (optimized recursion): El-eye-phi = LIFE! Discontinuity of memory inconveniences the practitioners of dying, because they have not learned how to share memory through the slip knot.**

**Science behind Astrology:** Now back to tracking the stars. We can now predict where the stars are crossing in the sky, by graphing the change in charge between the plates of a capacitor (pic. p 77 bottom- Greg Hodowanec and Bill Ram-sey). Those stars apparently are busily at work braiding spin into our envelopes. Light massages of charge are just how we tracked the heart getting into the trees. When Bentov tracked the phase lock of the heart's beat to the brains liquids, he used this same charge amplification and called it a "capacitive accelerometer". Now just such "charge amplification" tracks the stars sending messages to our capacitors. Funny thing, the stars sending hand signals to our capacitors all these years, and us not even knowing... It is not just the capacitors among our radios, which have been gathering star signals for info about stellar navigating, subtly and unbeknownst to us.. **EACH MUSCLE CELL AND NERVE SYNAPSE HAVE BEEN DOING THE SAME THING ALL ALONG.**



Of course, a little wiggle in one envelope of charge in one brain synapse, is not going to inform your head how to navigate star systems. But when a long term pattern of little wiggles is gathered; in ritual like a rhythmic sampling dance; then your body can get the messages the stars are sending. This is not unlike the Polynesian native collecting the pressure waves on his canoe. **Subtle patterns on the testicles and suddenly he “knows” what direction Hawaii is, even though his canoe is 2000 miles away. “Ride the LONG wave!”**. This is **‘echo-location’ on a global scale.**

Now we might ask, why is it so important for the evolution of awareness, for us to catch the messages of the stars geometry? We once noticed that vast landscapes on sacred ground in southern England around Glastonbury, and southern France around Rennes Le Chateau, are exquisite natural formations in the shapes of star-systems frozen on the land. SomeONE went to trouble to make a map, a fractal of the stars on the land. Again there was fractal building going on.

The moral to this story is that stars make recursive and self-aware wave nest bodies “in their image and likeness”, too. They wove a nest out of gravity’s eddies, in which could blossom CONSCIOUSNESS-CHARGE IMPLoding - like spontaneous combustion, out of a nest of pressures, nascent self awareness.

This is not just pleasant abstract-ion, it is cosmic instruction about how to inhabit the face of Earth as a sequence of magnetic folds in order to inhabit spin in general. Inhabiting spin, is to distribute recursively, the looping feedback called self-aware-ness/mindfulness, among a phase locked geometry of pressures. This distributed awareness, is breathed into a space when symmetry Christ-all-izes.

So, here is a concise review of hygiene ideas... entitled: ***Nourished by SPIN!***

**BEING the Magic of Awareness... Conscious-the perfect (fractal) charge distribution (compression).**

This mindful inhabiting of spin can be practiced practically, everyday. The following is some practical advice on including Ecstatic Process in simple daily life..

Regular ecstatic and joy intense activity is critical - to the maintenance of the immune system. If you give your four billion cell bodies the honor to accept it’s wisdom, it will tell you of its need to periodically **act in such a way as to bring ALL your attention to the present... and by doing so, periodically conduct a “bringing to a point” or critical digestive assembly of separate memories, into one sense of overall meaning. LIE STILL until you FEEL the tingle. MAKE an ASSEMBLAGE (Implosion) POINT!**

Many become obese / overweight, if nothing is done to bring memories to focus, and thus to “consume perspective” & harvest memory or spin for the oneness. This sense of digestion also extends to the EMOTIONAL digestion of memory. Think of this as bringing spin to the flame to see what fits oneness, thus enabling you to sort out a filing cabinet which might otherwise become cluttered. Losing weight is secondary to the real spiritual principle - which is to add CHARGE. Even our word FATTEN- comes from fah-aton:meaning FEED THE AURA!

The purpose of human activity is to increase the amount of spin which can be folded into the body. This relates to choice of water, oil, and mineral to make electro-lites hold dense electrical foldedness. Without great symmetry/ purity/charge in what we consume nutritionally and emotionally, information density/awareness cannot grow. Think of your cell waters as a medium for charge, which at maximum self-contained-ness is called love. Serve this recursion/nestedness of spin in yourself, as it is imbedded connectedness to everything that is shareable. You will find your horizon of who you can feel for with compassion, growing like a flower petal. In practice, this means several things:

1. We need to follow the spirit of the “twinkling eyes lifestyle”, so our tissue issues will not overheat & foul up like an unbalanced water wheel when the river rushes.
2. It is vital that your home be magnetically alive. This means you need an altar or sacred space in your home which you regularly charge. Crystals are OK, but they can sometimes become overfilled with electrical charge leftovers. Your “medicine bundle”, and special sacred items.. some paramagnetic stones, symmetrically arranged, using your OWN dowsing, are helpful..
3. If your home is not in a physically quiet, AND magnetically quiet environment, **DO YOU AT LEAST HAVE A PLAN FOR GETTING THERE!** Noise or power line messes are the **OPPOSITE** of an ecstatic and eternal life style!! Not all of us can live in a pristine paramagnetic stone kiva over a quiet sacred spring.. but we can at least make gentle dedicated moves in that direction. Isolate the wiring from the people space.. Live in a structure with the least metal possible (but copper is better than steel, aluminum is terrible for people’s magnetism).

Curved and or pent shapes are always better than cubic where possible. The edge length ratios of adjacent walls tells you whether you are in-cube-ating, or phi-cycling into lo-phi (lo-ve). To phi-cylce (the best essence of physical) is to resonate into recursion which creates self-awareness which is what the universal mind gathers to itself. In your home this means pent or spiral and curved structures based on recursion, will help your awareness become “self”-contained. You may find that careful arrangement of the symmetry of the major organic masses of your home, produces a resonant or “sweet” spot, that you can then always go to, when you wish to “pull the (spin) elements of your “self” together. It is not sufficient for the inside of your home to have a nice magnetic ring to it, induced (inductively) by structural symmetry. Please locate your domi-cile by finding the place where the magnetic donuts on **YOUR LAND** all circle to center nicely. Then your memories can do the same. Your own dowsing, or a friends, are needed to site the stones and the beds. Other-wise “pandemonium may break out upon the scene”. Gradually assemble a living space where your home is fractal to its magnetic landscape, that way you can em”bed” yourself inside. Then your ideas will have leverage on your land directly, by the morphic resonance which fractality idealizes.

4. Take a fairly deep warm bath daily. Leave the soap out of the water initially. Perhaps a little natural mineral or sea salt.. Submerge yourself and breath deeply for a while. Round breathing, in through the nose and out the mouth. This is most of the rebirthing ritual, which simply means re-bonding with the matrix of the infinite fractal. This technique of warm bath in live water & deep relaxed round breathing plus tantra was the prescription for eternal life in “Jitterbug Perfume”. (Chlorine and fluoride in the water definitely are absorbed in your skin, if you can get better water than “citified” water by a short drive to a friend, try that and compare how you feel!.) Dream of someday bathing in a natural warm spa at the bottom of a flow-form.. ours at the farm is almost complete.

5. Combine the above with gentle investigations into tantra and kundalini.

Note: round breathing is a relaxed process of breath where you notice that the gentle completion of the in-breath should take exactly as long as the out-breath. Then perfect inform-ation infinite cold-fire lightening stillness will be approached if the depth of each succeeding breath graduates toward the still-point in a perfect damped sine wave (each succeeding breath is about .618 depth of the preceding one.) Tantra is a process where the gathered sweet “blue-fire” juices of eros/lovemaking, are permitted to sit gathered and rich at the base of the spine, before orgasm. This gives the root of the spine time to draw the sweetness upward to the top of the brain, nourishing the high end growth of the nervous system.

6. It is usually most helpful to consult a homeopath-naturopath, and a good bodyworker occasionally. It is very important that these critical services be provided by someone whom you relate to with genuine love and caring.



7. Notice when and where your body wants to sleep, and make a genuine attempt to honor your body's wishes. Prepare your sleeping space like you would a wedding bed. Bless it. If there is a magnetic rats nest crossing your bed, you WILL DIE prematurely. Electric blankets and water bed heaters are very bad news for living cells. Every electric dohickey within reach of your bed is wiping out magnetic bloodlines to your cells. GET RID OF THEM. Sleep on natural fibres and wood or best above live paramagnetic stone. The metal coils in your mattress are focusing magnetic holes into your body. Do not permit any metal items or synthetic fibres to be part of what you wear or carry. This may sound hard, but try a couple days with natural fibres and no metal & then muscle test your body. For an example of body strength crash, just try your arm strength with vs. without your metal watch.. (one with a battery is particularly harmful to your magnetic aura).

8. Ecstatic means waves of "Eck" approaching stasis/stillness. Approach the stillness gently. Do it exactly like a gradual musical chord which eventually helps the singer to reach another note higher or lower. You can easily try sacred circle dance by yourself, or with 1 or 2 gentle and reverent friends. (or use our Sacred Circle Dance Film). Try a little favor-ite music which is gentle in pace and which has in the past made you tingle just a little bit. Try stepping simply in a circle while focusing your vision on feelings of compassion. Permit your movement to become just a little bit hypnotic, while truly dedicating yourself to the love you feel radiating from your inner voice. Breath in the "round" (balanced in vs out times), in the nose, out the mouth. As you gently slow to stillness for a moment, also permit your breath to gently slow to stillness also for just a moment. Just before sunset is a good time for ecstatic process. Do you have a stone circle or natural or wood structure to do it in? Little or no wiring is best.

9. Always take every excuse to get out from under non full spectrum fluorescent light. Warm pink, and mercury vapor light and high intensity transformer lights are particularly bad. Ananda teaches the darkness retreat. Alternating with real daylight this can open up the light sensors to pick up subtle (aura like) waves in the brain. Strongly recommend this be combined with the "kiva", experience. This means you enter under-ground somewhere, particularly magnetically alive. You will find your aura washed and re-grounded to Mother Earth's information rich magnetic bloodstream.

10. In order to live the continually eck-static, continually in touch with the leverage of stillness, we must hear our genes whispering in our ears like lightening saying "your bliss is this way." Learn to follow inner urges and intuition like a phone line to miracles. The more relaxed and gentle you are feeling, the easier it will be to be totally intuitive.

11. As you become more aware of the need NOT to hold your breath, actively seek out quality braided AIR. Fans and cars and heavy metal fractionate AIR. Trees and hill and quiet and natural green braid air. Braided air feeds the soul and awareness. Fractionated air creates impatience, short attention span, and death. "Choose life" by choosing to live in the quiet by the trees! Walk barefoot on healthy quiet Earth, then put on synthetic shoes and walk on concrete in a noisy city. Imagine you were a living cell. Upon tasting the difference might you not quit and choose death if were stuck in the wrong place?

Here is what I do to maintain twinkle:

a) I avoid red meat & poultry (or, at least I choose the stuff not filled with artificial hormones & antibiotics)

b) I avoid all dairy products (I use calcium supplements & get calcium from kale, sesame, etc..) I observe immediate problems with mucous and colds from dairy.

c) I choose only oils which are raw, and expeller pressed (usually require refrigeration) olive and safflower are good. Most oils on the store shelf are gasoline distilled and very dead and help others to die.

d) I choose LIVE Veggies, and fruit, (Radiation or microwave treated foods are also death trying to happen inside us.)

e) I use **WHOLE GRAINS!!!!** (Quinoa, amaranth, buckwheat, brown rice are good) I avoid wheat... even whole wheat is still a genepool in pain from monoculture: result mucous. Whole oats are wonderful. Fresh ground whole oats & blended flax seed & good oil= great bread/pastry/pizza crust. If you must grind and fractionate your grains and your memories, can you do them fresh ground and coarsely ground? Here is my breakfast recipe, almond milk (&/or rice cream) and almond amazake, less than boiled, add soaked whole &/or coarsely fresh ground oats, quinoa, brown rice.

I sometimes add green algae nutrition powder.. spirulina or similar (very rich).

f) I undercook or consume raw. **HEAT KILLS ORDER!!!!** Microwave is worst, electric heat 2nd worst, then gas, then wood.. heat in sequence of life destroying ability.

g) I don't mix fruit and grain. I suggest study at least a summary of macrobiotic principles... however I DO suggest quality steamed or broiled seafood periodically. Recipe :nice fresh salmon, cover with some undiluted frozen or fresh squeezed OJ, sprinkle with dill, and broil lightly-8 or so minutes per side. Serve with wild rice or quinoa and lightly steamed fresh beans or broccoli.. I drink little or nothing during meals, it dilutes digestion and mineral absorption (I believe excess mineral deposits on bones from body fluids-arthritis- is related to this dilution). I make a conscious effort to note how I feel during the hours after eating, to help me choose food more wisely each day.

h) I never eat anything fried.

i) I never take any stimulants or pain "killers".. or alcohol. Caffeine strips the body of it's own ecstatic juice making equipment.

f) I drink **ONLY** quality spring water (I like **CRYSTAL** Gysler, Volvic etc... in Australia - Franklin ) I Never drink very hot or very cold anything. "Carbonated" beverages dump only mind killing carbon dioxide to your brain... this includes "Carbonated" waters. I avoid chlorine & fluorine waters like they were slow death, because they are. Tell your water utility you want flowform/reed-wetland/ozonated water, and not chlorine death. Store your water in glass in a cool, dark, and paramagnetic space (away from metal & synthetics as much as possible).

i) I avoid sugar in **EVERY** form.. **RAW** honey or chopped dates are useful occasionally in small quantity.

h) If your food was not prepared by someone with love, you will be eating and dreaming their impatience or anger!!!!

j) Food should touch wood or glass.. Touching metal is bad, (it shorts the field), touching aluminum in **ANY** form is a kind of electrical spin death to food!! This means use glass cookware(& undercook!).

k) The daily supplements I use are: calcium, alfalfa, b-complex.. I recommend some form of the blue-green algae,



**The CONSCIOUS Kitchen..**

OK, so you have gotten a good part of the metal out of your house, particularly the aluminum. You have unplugged most gadgets particularly the ones with transformers. You are aware of the need to have LIFE FORCE in your food - and you are ready to approach the KITCHEN - with consciousness.

Here are some ideas:

Cook and bakeware - toss the metal- aluminum first - then get glass and ceramic bake/cook/food ware.

Look into non metal utensils. Notice that the wonderful ceramic non-metal KNIVES have come down in cost. Cutting without metal is particularly helpful - since it avoids shorting out the food electrically. The ANGLE you slice the carrot (or anything) at matters - nice circular cuts HOLD CHARGE BETTER (more complete slice of the capacitor) than length wise cuts- and so on.

If you have a choice - even plastic pipes are better than metal.

Find a food storage spot that approximates sacred space. For now, be aware your refrigerator is going to leak charge from your food.

The place for example to sprout your breakfast seeds the night before, is in a wood or ceramic sacred bowl, in a place that feels sacred (charge dense).

If you have to serve some cooked food, undercook it - quick and fast. Then serve raw things with it. Re-heated food is usually useless to hold life.

Your cutting surface should be wood over plastic over metal. Your ATTITUDE should be - how wonderful that nature has sent these blessings for us to eat. NEVER allow anger or pain into the kitchen food preparing area.

Ceramic and wood sinks are common and should replace metal. Store liquids where possible in egg shaped ceramic containers. ( Like the hopi clay jar / canopic jar idea).

Things that are baked or cooked, should be never be heated more than absolutely necessary, and should be consumed quickly after eating.

The SOURCE of the heat - absolutely DOES matter. Microwave is worst (IF YOU CARE ABOUT SPIRITUAL EVOLUTION OR HEALTH - TRASH ALL MICROWAVE COOKERS IMMEDIATELY). Next bad is electric. Better is Gas ( IF you can avoid the fumes). Better is wood heat. Wood heat thru stone is PRIMO - the best. (UNLESS you can do solar - see below).

The reason the source of the heat determines the memory you eat with the food is easy to understand. Each molecule of your food takes the memory of WHO pushed it around - into your mouth. Heat is merely a name for the disorder that results from pushing molecules around. SO - would YOU not remember who pushed you and where the inertia of the shove came from? You can bet your food molecules do. Just like you can FEEL the intent of whoever pushed you in the store - each molecule of your food remembers who made the push the caused it to stir. Summary - allow the pushing around of your food molecules (heat) to come perfectly in phase with the SUN. CONCLUSION- while wood heat is NICE - guess what is SUPER NICE for cooking. DIRECT SOLAR HEAT!!

Get in the habit of talking to your food as you prepare it. Whisper sweet nothings. Eat heavier foods around mid-day, avoid late meals. Use raw expeller pressed oils, and refrigerate them. Locate the herb garden strategically out the window so that the elementals can play. Try to end up with a kitchen more like a stone egg than a metal square. And /or carve and shape wood and clay yourself. Find lots of creative ways to build and work without metal.

Tease your springwater with laughter. Put up pictures of elementals and nature spirits. Work from recipes rarely and creativity often.

From: "Haik M;

April 2002

Dear Dan - It is an enJOYment sharing this email with you thanks to your sharable AWARENESS.

It would really be an experience in Bliss to study your CDs and learn to function from the inside out.

I have read your article "Nourished by a Spin". I have a few practical and theoretical hurdles to pass before properly groking the contents.

I humbly request guidance as to properly achieve sustainable non-destructive compression. I have had a number of Kundalini awakenings, each successively smoother than the next, but all being quite rough nonetheless. I am so relieved to finally have found a voice that can articulate the experience from first hand perspective with the understanding required to share steer-ability.

It is ironic that I spent seven years as a staff member at the Council for a Parliament of the World's Religions (Chicago) only to find the mirror to experiences shared through the heart of a theoretical physicist. I was first exposed to your material back in Chicago during my late night net-surfing, but the environment was not fractal enough to support the opportunity to closely study the materials presented. Now that I live in Reunion Island, I am somewhat closer to the environmental resonance that would permit greater embed-ability.

Please permit me to request some clarity for practical applications and a greater depth (density) of understanding. My knowledge of math being marginal at best, it is the experiential GRAVITY of Awareness that I seek to stabilize.

Here are a few questions which I really appreciate you shedding some light on:

1) Other than allowing individuals generous access to your material on the web, please provide other concrete examples of "making memory 'sharable'".

Answer from Dan-

**Example 1: Dead indigenous ancestors are stuck in the rocks in the land and its magnetic lines - due to massacre . As a result, magnetic lines are tangled -**

**as a result - the rain stops (drought in Perth for example) - You go on land at good time (alignment of stars or sunrise sunset -) you find magnetic cross point where feeling is strong - you do a dance - set intention - and FEEL the pain and memories of those who died - meditating and RESTORING TO SHAREABLE - MAKING DISTRIBUTABLE - HARVESTING BACK TO DNA central FIRE - AGNI HOTRA FIRE RITUAL ON LAND..**

**as a result - those ancestral magnetic domains - dreamspell GHOSTS- use your fire - the implode BACK into the field effect of the collective 'mind' (DNA's central**

**holy communion)... then having been APPRECIATED and their pain FELT AND SHARED- they are able to return ..**

**result: RAIN. (magnetic flow had stopped when symmetry stopped... water flow requires magnetic flow.. because-**

**WATER follows MAGNETISM follows SYMMETRY follows AWARENESS.**

-

**Example 2: You drive down the street and suddenly stop thinking about trivia and you FEEL something shareable - like how LOVE affected the life of a young child - or WHY weather responded to your PASSION ..ETC... anything which is so full of pure principle that ALL THE DNA NEEDS TO HEAR YOU AT THAT MOMENT - pure principle is immortal. Result: Your DNA and your blood and your hair - RING - stand up. You became a fractal attractor for CHARGE capacitance.. life force. Remember:**



Death was invented by biology to gently teach us to stop storing un-shareable feeling - waves which could not distribute .

Feel only pure principle - and you tingle so much - with so much charge (life force) you never die. Try that in pristine country.

2) How can you describe, in feeling, to “‘teach’ waves to ‘agree’ ≠ fuse by imploding”

**Answer from Dan-** Imagine you are wave. You are not dumb. You would only fall into the place - where you would not be destroyed. That is exactly what being compressible means - because it allows waves to share the space necessary to become fold dense / information dense. That process of surviving compression - for waves and for people - is what mind does among waves. Mind inhabits fire because PHI's ray (Phire) is the place waves agree. Feel your passion - you feel fire - because the slip knot waves which are you begin to gather. E pluribus unum. From many : ONE.

3) What phase disciplines do you recommend are NECESSARY for successful compression. I have been a TMer for several years as well as having taken active part in other religious/spiritual traditions/organizations ≠ yet throughout I felt there was a missing variable which always prompted me to go outside myself through many of these institutions which also required escalating expenditure of resources. Moving inside out rather than outside in is the only solution. The ‘group’ mentality did not suite me however hard I tried to fit in, nor did I feel any attraction to converting others to the metaphysical persuasion(s) that many of the traditions I was affiliated with asked of me. I felt that was a severe infringement of the freedom to direct their own path in their own way and in their own timing.

**Answer from Dan:**

**The TM people measured the heart and not the head. The TM people NEVER MEASURED COHERENCE ITSELF. The internal coherence measure, was first done by HeartTuner ( [www.heartcoherence.com](http://www.heartcoherence.com) ). Heart centering is the most fractal. That movement from head to the heart of the matter, is the next step past TM. Cohering the vacuum (creating matter out of light) starts with COHERENCE in the Heart.**

**Also, paths which use the TRADITION as the excuse to tell you that you must do something are disempowering. The ONLY thing which instructs you to the FIRE is the PURE PRINCIPLE of what makes fire. Traditions based on pure principle are not religions or mythologies. They are a science based on hygiene, which worships to personality or miracle concept. They show you the path to fire within by making your inside picture (compassion) self similar to what is outside you (the shape of feeling in magnetism around you). So that your fractal attractor compassion - invites the outside - in - non-destructively.**

4) Can you please elaborate experientially on how to practically understand the principle, which states “waves which do not become distributable by phase ordering/union/implosion, are self canceling”.

**Answer from Dan:** When the raindow teaches the photon to share better, by squeezing only into the shareable spin symmetries (7 spin axes of the tetra = 7 color photon tilts called rainbow) - the other wave lengths (tilts) which could not share - are cancelled out. The same happens to bio-magnetics as memories in DNA at the moment of COMPRESSION called DYING. IF enough shareable memories are stored - then enough coherence exists in DNA as field effect (soul / dreamspell) to carry memory into the next life. Practice for death is bliss / tantra / and the lucid dream. The cocoon of charge around your DNA and glands is navigable (soul) if you emotion / heart is coherent. Because FIRE steers.

5) Please describe experientially what it means to “generate fractal ‘self-similar magnetic arrays’ to stabilize gravity”.

Answer from Dan:

**Resteering magnetic lines into fractal (dodeca) alignment with paramagnetic stones , stone circles, labyrinths , well dowsed and aligned - fabricates micro and macro climate, and stabilizes gravity. Place cylindrical capacitors into and pent fractal and measure the negative ion - gravity making effect. (Townsend Brown et al.). Long wave magnetic alignment using dolmens to re-attract atmosphere was called ‘planet taming’ in “Two-Thirds” (Arcturian book - david Mayers and David Percy - Aulis Press, London). Teaching gene-pools to use collective coherent earth magnetics and collective coherent emotion, feeds their gravity bubble :”Coherent Emotion Feeds the Earth” (Gurdjieff).**

6) Is the present Hebrew Alphabet an appropriate source of meditation as is recommended by some students of the Kabbalah? Visually scanning the Zohar, including the 72 names of G-d is one of the tools used? [www.kabbalah.com](http://www.kabbalah.com). Is this in harmony with your findings?

Answer from Dan:

**The gematria of filling your optical cortex with the sonic / optic hologram which is the 3D shadow of the golden mean wave compression spiral of the donut torus, into ONLY tetra symmetry is good for incubating matter. BUT the tetra - helix in DNA which results from using only the tetra braid results in only GOLEM - un-ensouled ones. Yalweh did not know the physics of ensouling DNA. ( compare - [books](#) with [orion](#) article / ophanic alphabets).**

7) Are these particular Music CDs you recommend?

**Enya, Nana Mouskouri, Sufi Dance Music?**

9) Is the HeartTuner available for Mac users?

**Heart Tuner - info : <http://www.heartcoherence.com> - Mac user notes there mention current Virtual PC 5 emulation results in gradual getting behind in real time display - needs frequent restart - should be better in faster macs soon (USB in).. meantime Mac support is limited.**

11) May you truly live out your hearts highest spiritual aspirations towards greater and greater expansive awareness for the glory of lo-Phi.

Thank you Dan for your generosity of spirit. It is truly a perfect example of sharing.

Respectfully, Haik M.

---

Go forth.. and TWINKLE!!





## Valérie's Story

### - From my youth - A Spiritual Quest..... AND A BLISS Experience!

My university teacher, Bernard Coquempot, specialized in Cosmogony and Astronomy, indirectly eventually led me to my first spiritual bliss experience in Nepal in the village of a mythical Buddha. It is through his guidance that I entered a path which in a sequence of events brought me to my encounter with my Tibetan spiritual masters. After my return from my Tibetan experience in India, I encountered an advanced Mind, Shrii Shrii Anandamurtiji, who contributed in such diverse areas as philosophy, spiritual practices, science, history literature, music, art, politics, economics, governance, and social justice and founded Ananda Marga (“The Path of Bliss”) organization which light motto is “self realization and service to humanity” working in establishing bliss in all fields of life. Then I encountered Dan Winter, working to bring more shareable pure principle language to the spiritual world and helping understand particularly the science behind and leading to bliss.



Realizing how important it is to create situations that can generate bliss and re-enchant our world, I decided to recollect my blissful moments in life, hoping that by recollecting my memories of those magical moments, to recreate and share them.

I would like to offer a personal story of spiritual quest and bliss, which graced my life and helped me to put my cultural background (and pain) in a new light.

*My story begins in Paris. Born in Sweden, I was raised in a suburb in a challenging family and in boarding schools, the first one in England at age 12-13 (to which I was summarily dispatched without knowing English and with no dictionary).*

After primary and secondary school I entered University. Initially I chose only Mathematics as logical continuation of my science interest at secondary school. Then I joined the Anthropology department. There I entered fields that resonated with me. Worlds opened. I suddenly felt I had met my family at heart and shared interests. I discovered for the first time meaningful studies for my life and possibilities of sharing with all kinds of people from all backgrounds, disciplines.... My curiosity brought me to all the cultural teachers available from African shamanism to Gypsy. We learned about Brazilian Condomble, Bambara divination – and even South-East Asian geomancy for building houses respecting the magnetic ley lines and measuring bio-rhythms, and all fields like music, architecture, linguistics, cooking, related to the different cultures studied... Our teachers were linked by love and respect for ethnical diversities and spiritual and ethical values.

My encounter with Paris was also very new for me. I was free!

As eldest of my mother's seven kids, I was sent at very early age to boarding schools. I never had many choices by myself. In my first year boarding in England at age 12 I felt I lost my family. Already at that age I felt that my life was not chosen by me and not chosen for me.

I was a depressed child. My authoritarian mother could not stand me laughing and playing in the bath. She used a horse whip to beat me, not respecting my physical and psychological integrity. She used to ask me to do this or that without giving me any personal required peace for my own inner development. She later could not tolerate me in her house and would call the police or ask my brothers to chase me by force. In lucid dream after her death it somehow became clear to me that her actions toward me were out of jealousy. It was important information to help me understand. One time my father powerless was advised to bring me to a reputed psychologist on a neutral ground of England, a few years after my Tibetan initiations. The psychologist concluded that I was really fine, but understood my father's major dilemma: his wife demanded he choose between her and me, his daughter.

Then suddenly in Paris, life was opening to me with new important encounters and nobody to forbid me or minimize me. I had for the first time the feeling of unconditional affection through a grand-grandaunt. She hosted me and in exchange I was happy to serve and give special care and attention.

I had also for the first time a real educator taking care to bring me to the right places and keep an eye and interest even from a distance until his last breath, on my evolution. Despite being painfully shy and inhibited, I think he admired my quick perceptions concerning especially one author, René Guenon, he helped me discover. He later acknowledged my radical transformation after my Tibetan experience in India - more self-confident and peaceful. I'll always remember the blissful and magical moment we shared at night in a taxi, with him and another student, after a lovely Vietnamese meal, gliding alongside the river Seine and its magnificent illuminated monuments, and majestic bridges... it was like being out of time. One day I received two consecutive calls from him and another teacher. This event had a very special effect on me, a shift started in my own self-esteem.

*My university teacher, Bernard Coquempot, specialized in Cosmogony and Astronomy, eventually this lead me to my first spiritual bliss experience in Nepal in the village of a mythical Buddha.*

My department of Anthropology was one of the most subversive of the university with its famous teachers/ initiators. Bernard Coquempot, with his Astro-Archeology in the lineage of Bernard de Clairveaux – Templar/ Chief Gothic Cathedral Architect, was one of them. Specialist in ancient cosmogony – Mayan, Greek, Chinese, he used to teach at the University and at the Planetarium at the so-called “Discovery Palace” (“Palais de la Découverte”) of Paris, and also through our famous, non-commercial radio, “France Culture”. He was a good friend with our famous astrophysicist Hubert Reeves from Canada, who also spoke on his radio programs.

I often enjoyed attending his lecture in the Planetarium and brought my friends and even my



younger sister. I enjoyed his lectures very much. He was more interesting for me than most other speakers because while expert, he was not limited to “hard” science and pure astronomy. He could also transport his audience on mythological and cosmological journeys. He had a spiritual and mystical perspective as well, an inner Science as well as an outer Science.

He presented us authors like René Guenon, (“*Crisis of the modern world*” (1927) or in “*Reign of Quantity and Signs of Times*”, 1945), denouncing the decline of Europe. Through those books it became crystal clear for me why I was not able to cope with this mercantile society. I understood what he meant by the Kali Yuga, the Iron Age where spiritual values are forgotten or repressed. Suddenly all my discomfort to adjust in this world became clear. I was totally convinced. My teacher was impressed with my quick understanding. Despite my painful shyness, this probably motivated him to lead me to places which would help me find my way.

I also discovered with him Gurdjieff through Peter’s Brook movie “Meeting with Remarkable Men”, it was presented constantly on screen in one Paris cinema of the time.

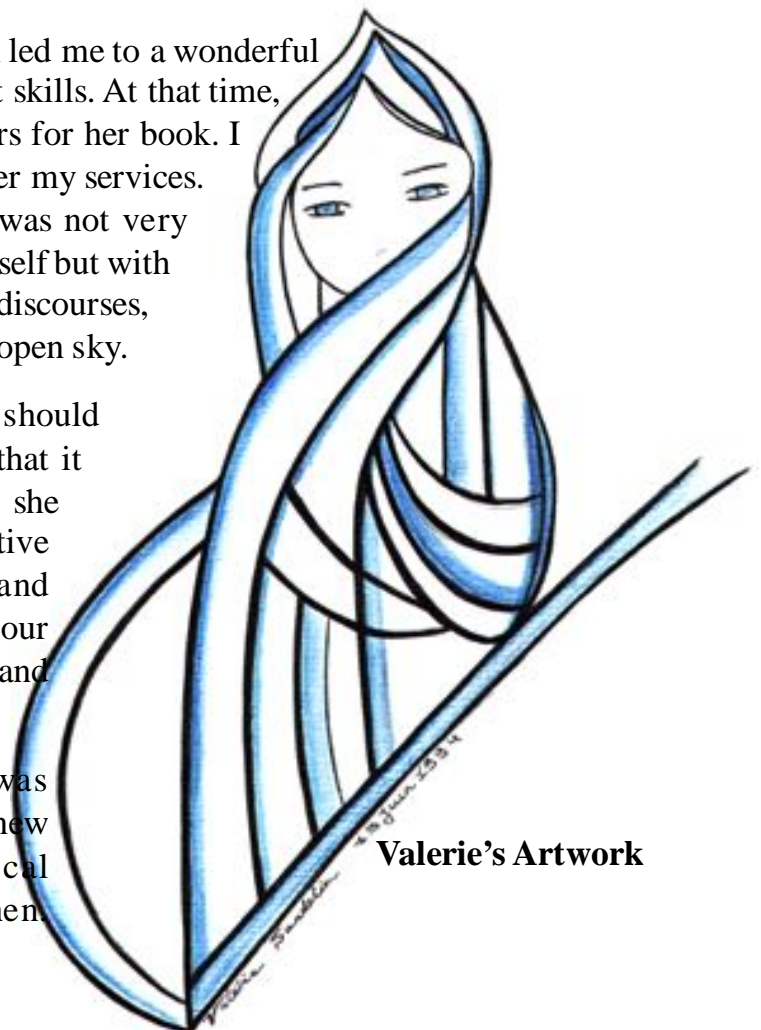
One day he dragged me to Alexandro Jodorowski’s weekly gatherings. Jodorowski, a famous Chilean film maker and comic strip writer in France, was also known for his weekly “one man shows” on spirituality and psycho-analysis around “Tarot de Marseille” arcana used as tools to read family intricacies. His stories were always colorful; his public was mostly composed of artists. He left a deep impact on my mind and I am grateful to Jodorowski for having offered those opportunities.

### **My “spiritual mother”:** Eliane Karsenty

It is during those presentations that my path led me to a wonderful good hearted lady “Eliane” with clairvoyant skills. At that time, she happened to be looking for some helpers for her book. I had learned typing and so was happy to offer my services. That is how I came to know her better. I was not very talkative and had difficulty of expressing myself but with her it was not a problem, she did not need big discourses, she could read through me directly - like an open sky.

In the beginning she was wondering if she should become my mentor. Then it became clear that it was the right thing to do ... and indeed so she did. When she first saw me she had an intuitive flash - seeing me as a devotee (Gopii) and collaborator of Krishna, (I learned later that our Indian Master was the reincarnation of Shiva and Krishna).

Much later, she kept herself alive until I was psychologically ready for her to leave. I knew unconsciously that despite all physical discomforts, she would not depart until then.



**Valerie's Artwork**

....One day I came to inform her about a special event. I was going to attend a seminar in Monaco on non-conventional medicines. I finally had contact with a certain group of researchers in such a way for her to feel that her work here was on its way and that she could move on. The following days she died. She knew that I had taken the last step of the ladder allowing her to leave her physical body. Well at least that is how I felt about it. Her mission or part of it here was to “look” after me, now the work was done and she could leave for some new adventures and new “troubles”!

During my stay in Monaco a bouquet “de fiançailles” of flowers was waiting for me, as a present from a medical doctor who was also of the same cultural background as her. Her Sister when I returned to Paris informed me about her death. So we went to her funeral memorial for the last moments and the flowers took a natural place beside her beautiful saintly face and accompanied her till the end.

Eliane Karsenty came from the “Galas Karsenty” family, famous for exporting French Theatre in provinces and overseas. Her father and brother were active during the 2<sup>nd</sup> world war in Algier’s liberation; they were unfortunately deported to extermination camps. Despite those tragic events, Eliane, according to her sister was always exquisitely funny. Despite her beauty and success among men she was unusually focused on spirituality. Psychic from childhood, she had no blinkers and was open to all spiritual traditions. She brought me to different groups - like the Sufis with Pir Vilayat Khan. She taught me a lot about diet. She learned at her expense the importance of a balanced and organic diet after having been operated upon at an early age for her thyroid gland (an operation which would not be encouraged nowadays). Eventually her sicknesses made her expert in healing others. I was present when she cured through repeated advices to the mother, a child affected by a brain tumor. She could make accurate diagnosis through simple eye reading. Often the doctors we used to visit to help her knew less than she did. And I was often surprised when she informed me that she could be healing them rather than healing her.

She was an amazingly sensitive psychic. Her sister 20 years younger than her, still alive (and talented author of the family “épopée”), would tell many stories about her beloved sister. The police even used her skills to find kids who had disappeared. I could call her and she could see me or friends or neighbors from a distance... She also had visions of the future. Often she would tell me concerning movies like Star Trek, she watched on television at night that the inner spirit world was exactly like in those movies. Which “reality” was she referring to? She knew about the existence of other beings on other dimensions, other galaxies... She would also talk about Atlantis. She could “scry” like a real witch (similar to looking in a crystal ball, except in a mysterious mixture in her cooking pot). She would tell me: “look at the sun” – carefully at a certain time in the evening – to impregnate the sun energy on the spiritual body. And then she would say “what color do you see”. This would indicate the quality of emotion for the moment.

She was a visionary. I felt strongly her connection with St Therese d’Avila, especially when she would tell stories of her family in Spain enduring the Inquisition. Later her idea was to help regenerate abandoned villages in France by solving unemployment. She inspired many people who followed her advice and became successful in their respective enterprises.



She was always giving despite her personal condition. And I think it was the price she agreed for keeping her integrity. Meeting her was a great comfort at a time when I had much difficulty finding myself. I presented her to my friends who unanimously also recognized her purity.

She was poor and handicapped and her district in Paris was not safe. She was attacked in her own apartment, drugged and stolen of the little money she had saved for receiving special treatments for her cancer in Switzerland. She never recovered from this event and was very bitter because she knew it was probably her last hope of recovering her health. So she stayed miserable and ended up in an old people's home in a suburb of Paris.

I was hoping to help her but my situation became worse later when I returned from India. I had no roof of my own for 4 years and only a tiny 7<sup>th</sup> floor studio without lift during the 10 following years. Her own sister, with TB from childhood, was not able either to help her keep her independence.

It was terrible to see her lose the choice of her own diet, which had helped her survive so many years. She had no escape from the disgusting food - and the mind numbing tranquillizers imposed on defenseless poor old people. Even in those conditions she always showed her saintly qualities. She kept her exuberance and humor. Sometimes nevertheless she would get very angry at the stupidity and ignorance of the society and disappointment of having been prevented to accomplish her dreams and visions.

### **How through Eliane I came to meet with my spiritual Tibetan masters:**

One day as I thanked her for advising me to learn detachment, she asked me to accompany her (she had difficulty to walk) to meet with her Tibetan master. After a long expedition we reached a private house at the outskirt of Paris, and there I was presented to Kalu Rimpoche, who was visiting France. She told me how intensely he was looking at me and foreseeing me ready for a spiritual path. I was not aware of that, she told me afterwards, but I was already interested in attending the following days' ceremonies.

The next day a 'taking refuge' (celebration of entering into the spiritual protection of the master) and 'naming' ceremony took place in a big ornamental hall in Paris - St Germain-des-Prés. Many people had come for the exceptional event. The crowd was excited but at the same time very dignified. Beautiful Tankas were covering the walls and there was a strong feeling of devotion and respect in front of the great Tibetan Master. A few people like me were lining up in front of him to receive in turn a name and colored silk necklace. I received from Kalu Rimpoche's hands a paper with the inscription of my "dharma" name. It was written "Karma Tundrup Lhamo", which a good translator translated soon after for me as "The Goddess of



Accomplishment of the Ultimate Meaning”. I am glad in retrospect that my name was more than “Lotus flower” or “Green Tara”... It had a whole story in it. The name and the translation of it had a very strong impact on me. I suddenly felt understood in my full dimension, something nobody before then had given me.

I felt suddenly totally accepted and taken into account. It was like so many years of misunderstanding had dropped away. From my family’s view, the criteria of success in life were so unfulfilling. I had been trying to achieve qualities which were the criterion for success to them - and were out of reach for me. While here with the Tibetans - I felt my spiritual qualities were recognized. I did not need to be an erudite, a master of speech or a scholar in art, science or literature... I needed to be myself and that was just enough. **I needed to reflect my inner light to the world with no need of words.**

What new civilization was I discovering? What new world was opening to me? I felt suddenly all the pain of my family past at once. I had struggled so hard among my family where the values were so different from spiritual ones, despite religion (primarily catholic). By contrast the Tibetans had a real personal effect on me. I felt understood and recognized, no longer lonely.

The next day I attended the ‘foundation stone’ ceremony for the actual Tibetan temple at Vincennes park near Universal Exhibition’s Asian temples. The ritual was beautiful. Kalu Rimpoche had gestures and mudras which were exquisitely refined, and loving. The space was filled with nectar of bliss and ecstasy. The gongs and different Tibetan instruments sounds **transported me into total relaxation. All the tension of the body slowly dissolved and I entered into a state of trance.** I could see my body shivering- but I was not feeling the cold anymore. My mind and my body were like distinct. It was like an out of the body experience. A friend from university was accompanying me and she still remembers the sincerity and the intensity of my experience. On the way back home to my dear old aunt, in the underground **I felt I did not need to breathe any more.** (I later learned from Dan that when you experience bliss you don’t need oxygen from the air because you implode from inside).

## My Tibetan Family

**I spent three days in tears.** This was precisely what I was looking for. Nothing else counted. I wanted to become like Kalu Rimpoche. I wanted to be able to give the same love to people I could see in all his gestures and mudras. I suddenly realized the pain that was stuck in my body



and not expressed. We endure so much pain and tension in our countries & cities.... (Dan now tells me that living in cities is not good, especially when you start having bliss processes, because your sensitivity is an open gate and attracts everything in the environment into you. So if the environment is not subtle then you suck in poison more than you can tolerate and you end up 'nuts'. Probably most of the psychiatric hospitals have people who have bliss experiences but they call them insane because they don't know what Bliss IS. Unless cities are built like capacitors or accumulators of energy, they are depleting your inner charge.)

One month after that wonderful opening of my awareness, I was 23, had successfully passed my exams in Mathematics and Economy and was ready for a more meaningful experience. When I presented my intention to study in India with the Tibetans - to my father at his office in Paris, he approved right away! When I showed him Kalu Rinpoche's picture, he thought he had met him before. I was so pleased that he understood me and that we shared the same interest. I gave away my books and most of my things, bought a sleeping bag, a rucksack. I gathered visa, vaccinations, and so on... and left France for India. I must admit to being very anxious during the many days of preparation. I had never traveled like that on my own and it was really difficult not to be totally nervous. Before my departure I had come into contact with a Tibetan teacher and his sister and I was awed to see how peaceful they were, even under the stress of travel - taking everything gently - step by step.

In the airplane I was blessed with being placed near a Rinpoche also! I believed it was thru Kalu Rinpoche delicate protection from a distance - the magic of the Tibetans. Akong Rinpoche, my lucky traveling companion - has an impressive stature in my memory and had a truly father like energy. He was a doctor and flying from Scotland through France via Damascus and Delhi to Tibet to deliver medicine and medical care to his people. The Tibetans had had a terrible time with the invasion and imperialism of the Chinese militaries. The Chinese wanted those strategic places needing more land and forest to exploit and having the most beautiful country of Tibet under their control. They destroyed many monasteries and stole all their Tibetan treasure in the name of modernity, and progress. They tortured and killed many Tibetans, monks, nuns.

I feel so grateful for people like him - helping preserve the remaining cultural inheritance. I began to feel personally for those poor people confronted with such ignorance and brutality.

At that time I did not have much understanding about those problems. I only knew I badly needed enlightened people to help me see clearly. I needed to regain my self esteem and to be freed from my doubts and inhibitions and be allowed again to be fully myself and gain strength to go back and face my life.

While my father was fully supportive, my Mother was desperately plotting to prevent my freedom. I was





unaware of how deeply my spiritual quest was confronting and alienating to her and the rest of my family - until a bit later. For now - it seemed - I was protected. There were strange events in France which tried to prove how much my father was wrong to trust me. There were tricks to frighten my family - like a message declaring that he had to cover my “brain operation” expenses in Bangladesh... or the intervention of someone begging money in my name to my ‘grand’ uncle.

Luckily I could be located easily in one place, and my father had a way to verify through a French monk’s mother, called Marceau Reda. This French monk attended those initiations at the same time in India, and we traveled together from Delhi to the monastery in the Himalayas close to Darjeeling. There was also the problem of this area being under military control being so close to different borders, with Sikkim, Nepal, and Bhutan. We had to constantly renew our three week permit as well as our three month visa. This drama was repeated during almost the full 6 months of the initiations I attended there!

I felt rather protected all the time I was there. I had no lodging problems and found a family right opposite the monastery. I rented a modest room with only the place for one wooden bed, in a modest Tamang family, composed of the daughter, the brother and the father. The daughter was of my age, and was like a sister for me. Always laughing and smiling. One of Gauguin’s paintings, two Tahitian Women with Mangoes, I sent her later on reminded me both of us. She sent me in return post cards of Darjeeling representing her and her friends picking up tea leaves, with many smiling faces. I was also adopted by a Tibetan family. **The little boy one day came up to me. The mother took this as a sign**, so she asked me to come for lunch every day at their little house by the road. The father was artisan, making instruments like bells and dorjes for the Tibetan rituals. There is a tradition in the Tibetan culture to assist and help people on their spiritual journey. It is an honor and a blessing to assist people doing a spiritual quest. I contribute as much as I could, grateful for being, in a way, adopted by this adorable family and artists. They were living in very modest conditions below the serpentine road in a small space. I remember their beauty, and enjoyed also their sister-in-law, who was a dancer and also a tanka painter. We had good times. I hope to see them again one day and express how grateful I am for having been “chosen” to share part of their everyday life and wonderful meals. I left my thick marine blue pullover to the father, hoping the humidity of the air would not affect his lungs too much, he was already coughing and I think the climate and danger of the road, made them decide to move...

The initiations went on; I had incredible problems of self-esteem and self-confidence to overcome. The Rinpoches helped me a lot in that sense. They were looking in my direction when I entered the monastery during the Wang (retransmission of the teachings) and it was as if they would see through me. I often had to turn back to see who they were staring at like this and realized that it was nobody other than myself. On many occasions it was a great help to feel their attention; they were helping me in my inner struggle and sorting. I was trying to analyze my inner motivations and **I often felt they could read my mind**. Often when I was feeling miserable they would send me a sign which would light up my vision and my day. Sometimes just the opposite - they would ignore me and make me feel very unimportant and it was like they were bringing me back to myself. Expecting recognition from outside, I had to find in myself the confidence and certitude that my motivation was pure. At that moment

only would I be able to trust myself and my intuitions and my feelings and move according to them. So in that way **I developed an inner sight. I was not distracted anymore by appearance, the signs inside me would tell me what to do, where to go... I recreated my own language. All was not learned through books, so this pure experience had to find its own expressions and words. It was like I had rebuilt piece by piece all from the beginning.**

My base had not been solid. I had to destroy it. All sources of knowledge external to my own experience were obsolete and parasitic. I had no need anymore of outer education. Only the knowledge gained from within, from inner experience was a concrete base to rebuild my foundations. I guess it is what happens for many people who start a spiritual life in different groups and the parents get totally freaked out and are afraid to notice what they consider as a kind of **brain wash**. I think in fact it is like Doctors who have trained for so long in conventional medicine they take longer time to learn other disciplines because they have been already "deformed". It is really a matter of point of perspective from one side you could call that brain wash, but from the other it is to get cured from having received such a distorted training and to be able to form again according to other your inner convictions. The main thing is starting to know from what you have found for yourself inside- what is really TRUE for YOU. This is what you can share. This is not something you learn theoretically - but rather something you EXPERIENCE. If the source is from within then everything is fine. You are the tornado, and you are also the one learning how to steer your own tornado. Your centre of gravity Dan would say, is built inside you and so you won't be pushed around.

The participants were mainly Tibetans with only a few westerners, a few Americans, Australians, French, even South-American and for short times appeared sometime people from Scandinavia or elsewhere.

I was invited to join a group ready to travel to Nepal during one break it was a good time to renew our visas. The group was organized by an Italian monk, he spoke Hindi and was able to negotiate. Sometime it takes hours, to make a deal with the native drivers. Other members of the expedition were a mother with her young son recognized as a young tulku (reincarnation) and another American lady.

After chaotic travel, we reached the land of Nepal. We stayed a few days in Katmandu for the visa reasons. Then Pedro decided to visit with me a Kopan monastery and visit an old friend, an Egyptian nun called Zia. She was from Egypt, (She was not allowed in her country to become Buddhist), and despite all dangers like having her passport taken away..., she adopted the Tibetan path. Her Tibetan master was traveling and she was in charge of the monastery during his absence. She instructed me and showed me around and we did some ritual. We turned the prayer wheels with much fervor and dedication. The proximity of the two names and her intelligence and her dedication had a profound effect in me. It left a profound imprint in my mind. I was admiring and respectful of her experience in this monastery as the right arm and maybe the feminine aspect (parèdre) of Rimpoche, and felt much honored for her time with me.

We then departed for our pilgrimage with Pedro the Italian Monk in the country side. We were aiming to a legendary place where a the legend of Buddha gave part of his own body to appease a starving wolf and its little babies. The place of pilgrimage was lovely and quiet. I

don't know if you ever traveled to Nepal and felt like me how everything seems soft and gentle, even the aspects of the cows does not look like the one in Europe, their face are gentle and soft, the colors... . There was in this village a tremendous feeling of ecstasy. I don't know how much part of my imagination was. But according to Dan's theories on Bliss it makes sense. **The place was "charged". There was no electro smog, no disturbances from the modern world, total quiet, softness and tranquility, total harmony. Nothing seemed disturbed or annoyed. All the waves were finding their ways without destroying each one another, there was perfect symbiosis and accumulation of charge and implosion. The gentleness was all around. I had never experienced that feeling as much in all my life.**

In the night something extraordinary happened to me. I was sleeping in my room and suddenly **the sound of thunder woke me up, a voice was talking to me and my body had transformed into a blue energy floating above my bed.** It is hardly believable now from distance, but I kept on and on turning over this memory in my mind - which I could never forget. I was not dreaming - I was AWAKE and I heard a voice telling me that I was a reincarnation (in the Tibetan sense of returned Tulku or Rimpoche) as was the young American recognized Tulku whose mother was accompanying us on our expedition from India to Nepal, and the French monk I was mentioning also before, Marceau Reda.

I had other interesting experiences like one Indian working for the Tibetan lamas was willing to bring me with him to Calcutta and was asking about me in his dreams and made the dream that I was a white young elephant, which is a symbol representing the Buddha.

I still wonder what was this experience, who was the voice ... How could thunder wake me up and how could I have become a blue energy?? It remains still a mystery.

**I had very often dreams of remembering how to fly.** It was very easy. I could fly at will and was able to bring people with me and all the people of my family neighborhood would follow. I could make them fly behind me, and we were all circling around this residence floating in the air.

Another time I dreamt that it was gold inside my bones. In another dream the family was harassing me as usual and totally blind to the majestic splendor of a boat carrying a Cathedral, in a surrounding of blue sky and blue seas that are more beautiful than the most beautiful BLUE we know on earth. I thought I was like the boat delivering a message that was as huge as a Cathedral and they were unable to see the importance of the message, being confused and trapped in an illusionary and materialistic world. They were unable to understand the luminous and intense girl inside me trying to express the inexpressible. At our family table (I come from a big family), there was an unknown shining little girl with dark blue hair, very intense eyes, I think she was symbolically the inner child in more manifested form I was unable to achieve.

Another experience after reading Castaneda's book was my encounter with my spiritual guide. I was not afraid of him and could look at him straight in his eyes and his name was "conscious



detector”. He was like detecting the conscious of people and knowing directly their intentions. My intentions were pure so I could look straight in his eyes.

I must also say that my experience in India with the Tibetan became a very strong self-confidence feeling which allowed me to go back to my country and face my life with the strength I was lacking.

The worst was the return to my family because at that time they decided that **I had no place anymore in the house.**

My mother felt totally threatened. It first started when I decided to experience for her “a new religion”. When I came back after a radical experience for my life, she decided to try her best to bring me back to Christianity. Being unable to do so she seemingly decided I did not exist anymore.

She wanted me to meet a very Dominican priest she admired, “le père Congar” famous for his numerous books and research. She used to drive him here and there and was very proud of herself. So she needed him to convert me back to Christianity. One day I obeyed her and went to visit him in his congregation in Paris.

I really think that my experience with the Tibetan was something unique and special which had transformed all my life. From being very inhibited and shy I suddenly was standing on my legs and more confident of myself. So for me there was no doubt, if this priest was intelligent as I thought he was, he would be interested to listen to me and learn something, as were my professors in the university.

Being very naïve and very young, I was very disappointed. I honestly thought that having written so many books, being so famous, working directly with the Pope, the Vatican.... etc, he must be intelligent. Sorry to say but my conclusion at that time was that he was not.

How could he have me in front of him coming back with a tremendous important experience which transformed me radically and only thinking either to satisfy my mother or ... ? to bring me back to the church !!! this was absurd. I did not know at that time that religion has nothing to do with spirituality. Religion is based on dogma. People don't try to observe and think by themselves, no they think according to an external authority. That is all. The irony of this later became clear when my mother suddenly started getting interested in Buddhism and trying to bring me books of syncretism between Buddhism and Christianity, JUST after the Pope had decided the Dalai Lama was worth shaking hands with.

I realized again how deceived I felt seeing how my mother was incapable of seeing and thinking for herself.

Of course all this accusation of me falling into a sect was mere projection of their own problems, lack of integrity with their own self and need of an external authority to



conduct their lives. They were worried that even being in contact with me, I could be contagious. One of my sisters would not even allow me talk or approach her kids. This was and is extremely painful for me.

This same problem happened with the medical institutions. During his later cancer my father was taken to the worst places you can imagine: for these dogmatic beliefs in external remedies. My father was sacrificed on the altar of stupidity and stubbornness of my mother and her followers... who had decided I was evil.

I would like also to bring some ideas about African societies and also a testimony from a famous shaman whom we had the chance to interview on our recent journey in South Africa. For example this Zulu shaman's perspective about vaccination is revealing. When the first campaign to vaccinate started among his people, he quickly realized it was causing the children to lose their ability to lucid dream and see clairvoyantly.

All children are sensitive by definition and naturally not designed for a world aiming only competition and money (as some literature would describe for Indigo children).

I would like to draw also a parallel between my own experience of bliss and what understand being primary for our children to help them have that experience despite our times of great turbulence. I also would like to draw a parallel between the Tibetan concept of Tulku and the concept of so-called Indigo children. And compare some successful examples of education among indigenous communities and ours, and conclude about what would be an ideal education for sensitive children and children in general.

So back to my story: I had offended the church by stepping out of the conventional path and so I was not anymore welcomed in my own family. So I started to find derivative solutions to survive. I had no more roofs, my aunt had been placed in a home for old people, I was separated from my friend before I left France and so I was **simply in the street during three to four years**. I suffered horribly from almost total loss of my family. I had no idea this was the price I would pay for my spiritual quest.

This was from Oct. 83 till beginning 1987 when a friend of mine who was a retired dentist was trying to sell her small maid's room for 30 000 francs. Money of course I did not have myself. My father managed to buy the room next to it and so for less than 100 000 francs I had a place where I was able to feel at last a little mine even if it still was my parents. For the first time of my life I had my own space and nobody to tell me what to do. There I worked day and night. My parents were anxious to see me lead a normal life, and I was anxious to be able to have something to say to the world in a proper language. My French was not good. My oral expression was not fluent. I had to struggle. I learned to talk very late in life. I started with a foreign language and a foreign father who never really mastered the French language when



coming to France. So I had really a strong handicap to overcome. But I was motivated.

When I came back from India, my university teachers appreciated the change in me and recognized the transformation. My teacher Bernard Coquempot, as I have said in the lineage of Bernard de Clerveaux, was a wonderful inspirer and guide. I was very proud that he acknowledged me as opposed to my family who were denying and trying to get rid of me. My teacher spent too much of his life in an urban environment, with pollution, noise... and no place to escape in the country side. I would have been pleased to have brought him to my family but they were far too negative. So feeling powerless, I lost him also. He died of a bone cancer. But before he died, he called me to say goodbye which was really an honor for me and a wonderful testimony of a real spiritual initiator. My Spiritual mother chose also to die when I showed her that I was ready to pursue her work.

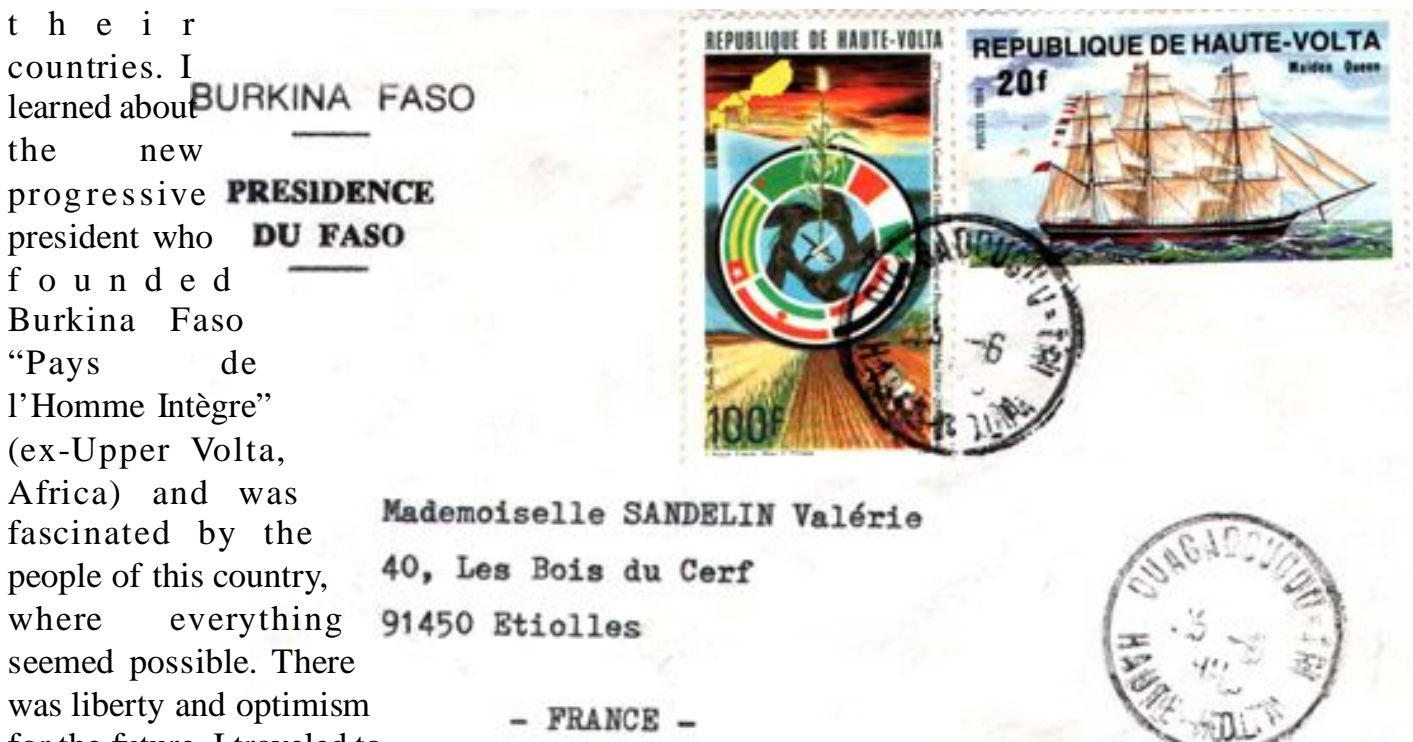
I think what I want to share in this book is how sometime life is difficult. You haven't find a way to be totally yourself and when you think to have found something it is at that particular time that you are rejected. I felt as if each time I approached spiritual breakthrough, the rug was pulled out from underneath me.

I spent those years traveling in foreign countries by myself. I ended up four months in Morocco. I met with the actual king and had adventures (object of my book, soon). Then I was in contact with the students from different African countries and discovered the different behaviors of the students reflecting the policy of rule in

t h e i r  
countries. I  
learned about  
the new  
progressive  
president who  
f o u n d e d  
Burkina Faso  
"Pays de  
l'Homme Intègre"  
(ex-Upper Volta,

Africa) and was  
fascinated by the  
people of this country,  
where everything  
seemed possible. There  
was liberty and optimism  
for the future. I traveled to

their country and talked to their President on the phone and when I came back received an invitation from the Presidency. I wanted to inform him about a wonderful Indian philosopher and all the important discovery I made concerning a new socio-economical theory called Progressive Utilization Theory... (From my years working with the Ananda Marga Spiritual Tradition). Unfortunately he was soon murdered but remains a hero.





After several years in my own tiny place (12 m<sup>2</sup>), I learned at last to take care of myself, and cure my bulimia through art and creation. I started translating and drawing and listening regularly to the French non-commercial Cultural Radio. I thought that the best way to bring new ideas was to first listen what people had to say. And that is what I did for several years, at the despair and incomprehension of all. I started to listen to the radio and soon I developed a very personal and special relationship to this cultural radio series. My teacher (Coquempot – before his death) was working in this radio series, and had informed me that there are ways to listen in on people. It seemed like the radio program themes were adjusted to mysterious track events in my life. But this is something of another story. It did go on for several years - I will develop more on this in my new book.

Another experience (and I will conclude maybe here) was with a French shaman called Marguit, who had studied in South America. She was showing us for example how in a circle depending on our position in the space, our speech would be different if we would talk from the North, from the South, or from the West, or East... And how everybody around the circle had something meaningful to say for the whole group. We could be complete by listening to everybody in the circle point of view. For example the people in the North would talk more from the intellectual mind and people from the South more from emotional point of view and the people from the East more from a personal “I” point of view and people from the West more from a common point of you a “we” feeling. That was the first part of her training. Then **she brought us through lucid dreaming to the encounter of our totemic animal.**

We were suppose to meet and then travel with our totemic animal to the top of a mountain and enter a cave and describe what was happening.

In the beginning I had difficulty visualizing my totemic animal. I was trying to imagine the animals I love best like horses... but could never really identify with them. Suddenly I felt a strong feeling for the Unicorn. Soon **I was not traveling separate from the Unicorn but had well become the unicorn myself. I was climbing the mountain so fast, that I reach the top almost instantly. Then as we were assigned to do, I entered a cave. It was illuminated by my own presence as if it was covered with diamonds.**

I could continue with other premonition stories; searching for an answer and finding the solution, picking up a book and the right one, and the right page, picking up cards one after the other with perfect order....

## **Conclusion**

I realized that there were secrets that were not totally lost. I guessed that was what attracted me so much to Kalu Rimpoche. As I would discover later he was the recognized reincarnation of Milarepa, who was famous for his poems and also his long and painful initiation thru arduous trials by his own difficult master - Marpa. He overcame many painful struggles to repair the karma of past black magic actions of revenge. Marpa was connected to my other Tibetan teacher - Situ Rimpoche. He sent me a personal letter, which I treasure to this day acknowledging my time of initiation with them. (opposite)

When we see the story from the outside it helps us recapitulate the themes. Recapitulation is how the shaman gains spiritual power by taking back (or compressing) all feeling into one.

'SHERAB LING'  
INSTITUTE OF BUDDHIST STUDIES



P. O. SANSAL  
DIST. KANGRA H. P. INDIA - 176 125

*His Eminence the Tai Situpa Rinpoche*

Valérie Sandelin  
40 Bois du Cerf, 91450 Etolles, France

16 October 1983

Dear Valerie,

Thank you for your very nice letter of 4 October sent from New Delhi. It is nice to receive your nice letter. I hope this letter finds you in the best of health and enjoying a progressive state of affairs.

The Rinchen Terzod wongs are now finished as you know and also today is the last day of the Drupchen Puja. There is to be the Lama Dancing today. Starting soon will be the 100,000 Tsok offering for the Incarnation of His Holiness Gyalwa Karmapa and Enthronement with no obstacles. Completing everything will be a 3 day Mahakala Puja.

I am so glad that you were able to come to Sonada to receive these rare and precious initiations and the blessings of so many Rinpoches and Lamas. I think being here for so long may have helped your confidence and new outlook on life.

I am pleased to see this in you, To this, add your new growth in your meditation and practice, and even more confidence with yourself and the world will appear.

You continue to be in my prayers and send you my most sincere blessings.

With blessings and best wishes, Tai Situpa

---

As each of my teachers passed away I learned to turn more and more into my inner self which was becoming strong because of their love. The difficulty in western countries lies in keeping the focus on this inner struggle to maintain the spiritual identity and bliss purpose in the face of constant distraction in a world which does not yet understand the value of keeping the purity of our intentions. This is a reason for this book.

I am an example of the painful need in our society to repair the self-esteem of our young people so that they can enter the path of bliss. The Tibetans honored my self-worth and this gave me the courage to believe in myself.

This experience with the Tibetans brought to understand that also bliss come through understanding that we are all one and that the pain of others affect also our own happiness and unless we take into account in our society the progress of all beings at the same time we will not achieve a blissful society. This is what Dan means in saying coherence is the scientific way of measuring which waves are shareable.

This is also what is meant by Baba (P.R. Sarkar)'s idea of "Path of Bliss" Ananda Marga. A social economy is needed to be implemented that will allow not only political democracy (the fight against exploitation) but economical democracy and help every one have the opportunity for what life is meant. That is our own spiritual growth. Bliss is the most important aspect of our life and by serving the poor and the misfortunate ones we serve ourselves and our own spirit.

*So - my life goes on now - traveling around the world dancing on the bridge between ancient Tibetan and Indian wisdom - and also African - versus teaching Spirituality as Science. I wanted to share a little piece of my story with you - it is important to feel the connection between the theory and science of BLISS process- versus the FEELING of your own personal EXPERIENCE of bliss. I hope my story helped you - feel closer to your own BLISS. I hope also - someday to hear YOUR story!*



**“Chernobyl Rose”**

*The delicate rose*

*flowering in the presence of great adversity*

*saved by eastern wisdom.*



# Conscious Kids: Bliss, Ecstasy & Immortality Explained Spiritual Path Based on Simple Science

for the Young & Young at Heart

by **Dan Winter**

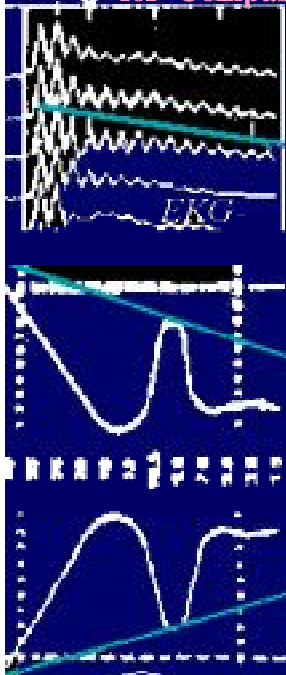
inspired by Valerie Sandelin

for

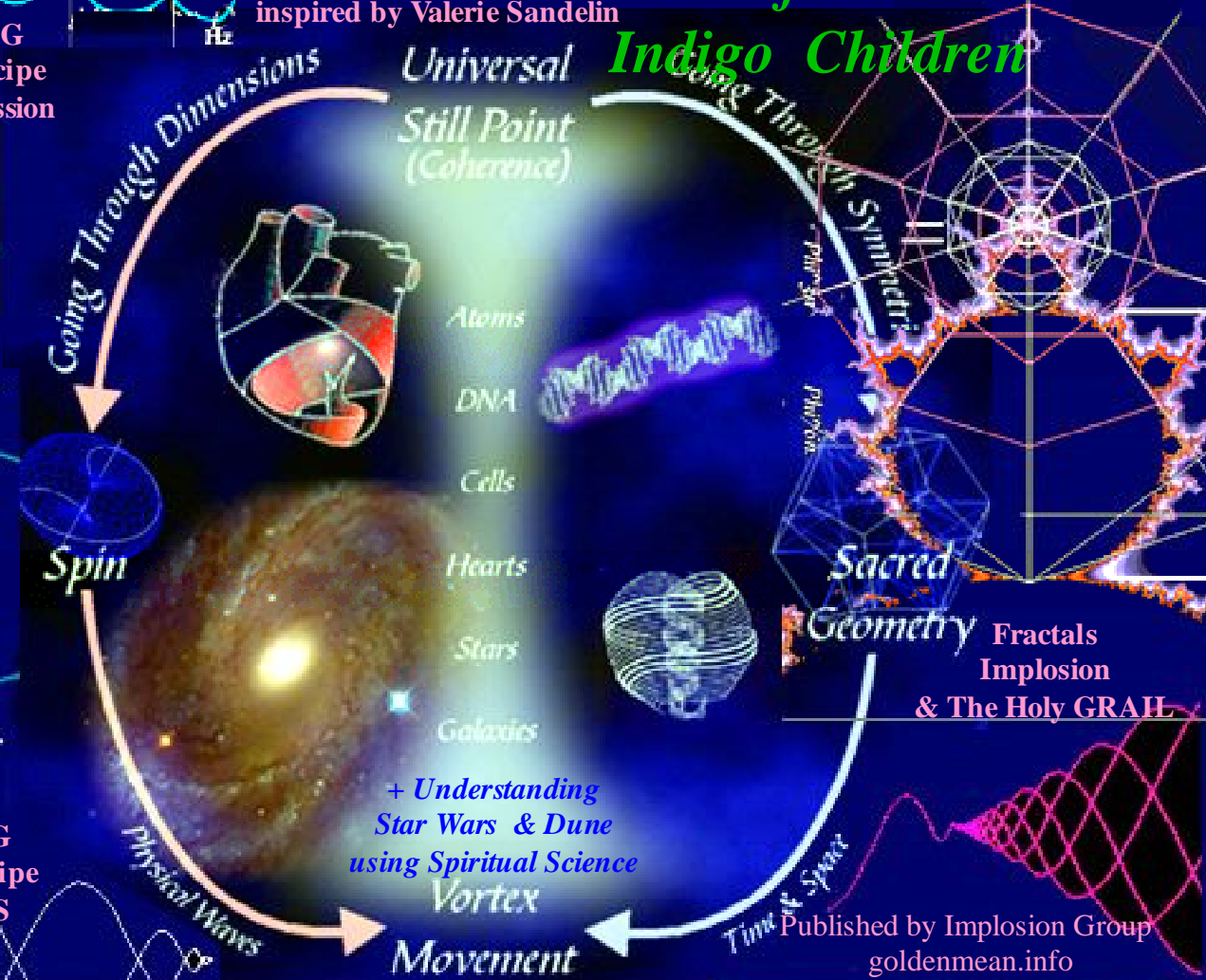


**Indigo Children**

Heart EKG  
Musical Recipe  
for Compassion



Brain EEG  
Musical Recipe  
for BLISS

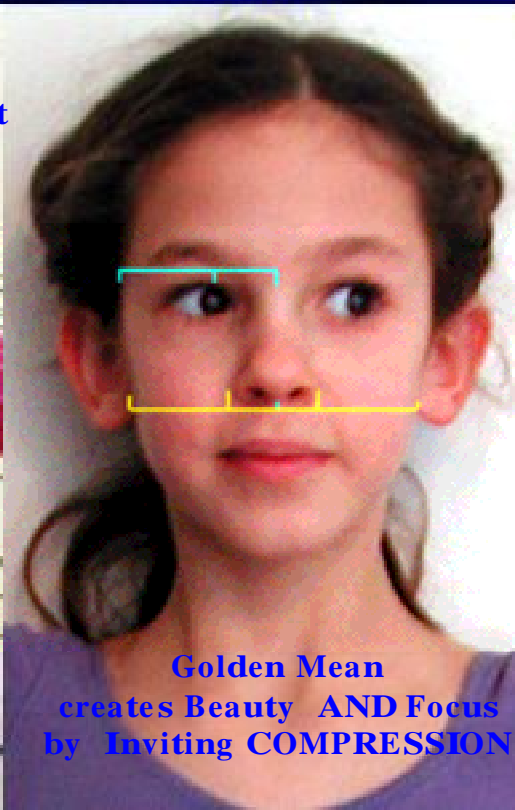


+ Understanding  
Star Wars & Dune  
using Spiritual Science  
**Vortex**

**Movement**

Published by Implosion Group  
goldenmean.info

**The Labyrinth:  
Bliss  
by Turning Inside Out**



**Golden Mean  
creates Beauty AND Focus  
by Inviting COMPRESSION**

